

SHAPING LIGHT.

HELPING ENGINEERS AND SCIENTISTS IN
ADVANCING HOW THE WORLD COMMUNICATES,
SENSES AND CONNECTS

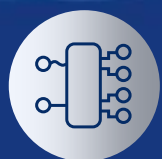

CORX – COHERENT OPTICAL IQ RECEIVER DATA SHEET

COHERENT OPTICAL IQ RECEIVER (CORX)

The Coherent Optical Receiver (CORX) is a fully integrated optical receiver that combines optical signals with a local oscillator signal using a polarization-diverse detector setup with four output channels.

Key Features:

- **High-Quality signal processing:** Provides excellent quality and matched channels, optimized for analyzing dual polarization multi-level transmission formats at very high symbol rates. Ideal for transmitter characterization and IQ modulated optical signal analysis in the C-Band.
- **Trans-Impedance Amplifiers:** Includes trans-impedance amplifiers to optimally utilize A-D connections, even for low-power signals.
- **Adaptive RF Gain:** Features per-channel variable RF gain and peaking to adapt and compensate for channel fading or RF chain imperfections.
- **Built-In Tunable Laser:** Equipped with a built-in tunable laser for coherent signal mixing.

User-Friendly Control:

- **Web-Based Interface:** Controlled via a built-in web server, eliminating the need for software installation on a remote PC. Accessible via any handheld device through a browser.
- **SCPI Programming API:** Offers a SCPI-based programming API for straightforward implementation of automated test scripting and remote control.

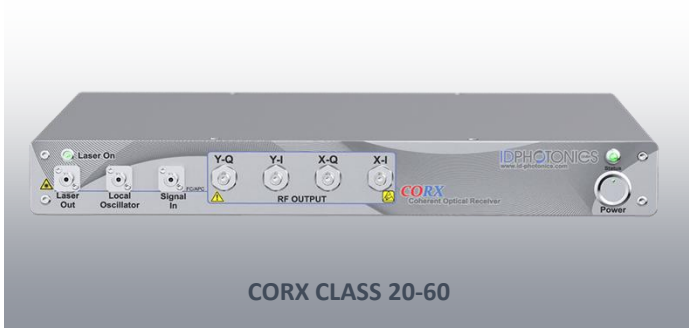

KEY FEATURES

- High-bandwidth Dual Polarization Coherent Receiver Device
- 60 GHz, 40 GHz and 20 GHz variants
- Built-in Trans Impedance Amplifier, per-channel variable gain
- Built-in local oscillator laser source
- USB & Ethernet interface for remote control
- SCPI style remote control command set
- Built-in Web Server for instant access from any browser enabled device
- 19 Inch 1HE Rack mount chassis

TYPICAL APPLICATIONS

- Optical Frontend for Oscilloscopes
- Testing of advanced optical modulation formats (e.g. QPSK, 16-QAM, ...)
- Reference receiver
- Testing coherent optical transmitters
- DWDM transmission experiments for system design tests
- Coherent detection DSP design

WHAT DIFFERENTIATES OUR CORX SOLUTION AND DRIVES SUCCESS

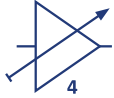

TRANS IMPEDANCE AMPLIFIER

Per-channel gain-tunable transimpedance amplifiers compensate for channel fading effects in applications such as free-space transmission. These amplifiers offer both user-controlled gain settings and fast internal control to achieve a user-defined output swing.



VARIABLE OPTICAL ATTENUATOR

A software-controlled variable optical attenuator at the signal input can be used to compensate for channel power fluctuations and optimizes the input power to the receiver.



SIMPLE, INTUITIVE USABILITY

A comprehensive GUI allows setting up, control and monitoring the unit within minutes. Remote control via Ethernet or USB gives a maximum of flexibility connecting to the board.



CORX IS FLEXIBLE

Utilize the integrated tunable laser when required, and easily switch to your external light source when it's not needed. If the tunable laser isn't being used for the CORX, it can serve as a versatile general-purpose light source.

DESIGNED & MADE IN GERMANY

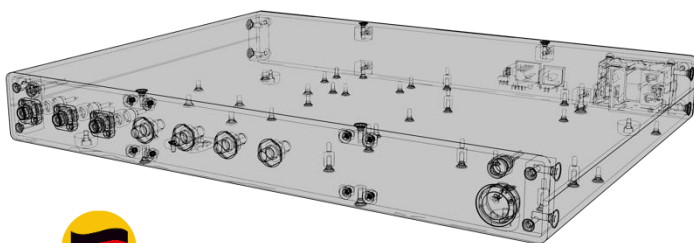

**DESIGNED & MADE
IN GERMANY**

BLENDS INNOVATION AND PRECISION TO ENSURE SUCCESS

German craftsmanship is renowned worldwide for its meticulous attention to detail and use of high-quality materials.

It signifies a commitment to exceptional quality and precision engineering.

At ID Photonics, our entire operations are based in Germany, ensuring top-notch craftsmanship. We handle everything from manufacturing and hardware design to software and circuit design. This comprehensive approach guarantees products that are reliable, durable, and innovative. By choosing ID Photonics, you invest in engineering excellence and timeless design, all crafted with meticulous attention to detail in Germany.

SIMPLE, INTUITIVE CONTROL OF YOUR CORX

The CORX comes with an intuitive and easy-to-use graphical user interface (GUI) that requires no installation. It's designed to provide a seamless experience, allowing you to control and monitor the laser with ease.

Simplicity at Its Best: Say goodbye to complex installations and hello to instant control. Our CORX features an embedded graphical user interface (GUI) that requires no additional software. Just connect, and you're ready to operate

Intuitive Design: Navigate with ease through our clean and modern dashboard. Monitor real-time performance, adjust settings, and ensure safety with just a few clicks

Plug-and-Play Convenience: Start using your laser system right out of the box. Connect via USB or Ethernet, open your web browser, and take control through the built-in interface

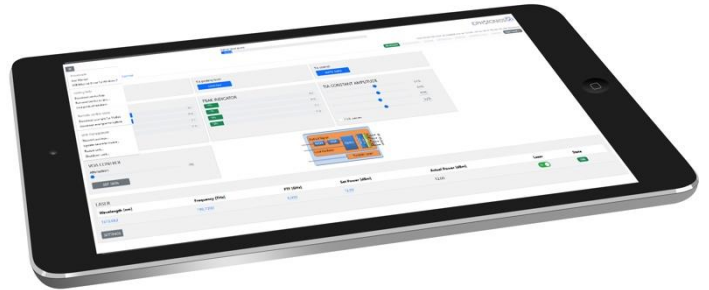

1

CORX - WEB GUI ON TABLET

2

CORX - WEB GUI ON DESKTOP

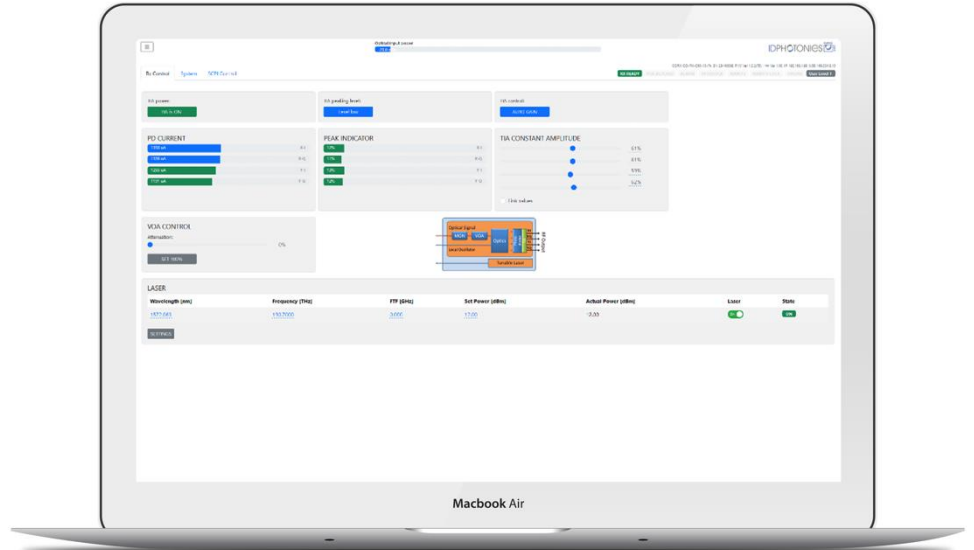



RECEIVER SOLUTIONS

CORX – COHERENT OPTICAL IQ RECEIVER

The CORX Coherent Optical Receiver is a turnkey instrument designed to seamlessly interface with any real-time oscilloscope, providing four single-ended RF outputs. It enables the coherent detection of polarization-multiplexed optical signals in the C-Band by mixing the test signal with an integrated local laser oscillator.

As a reference receiver, the CORX is ideal for transmitter characterization and the analysis of IQ modulated optical signals in the C-Band.

With bandwidth options of 60 GHz, 40 GHz, and 20 GHz, the CORX supports the processing of Terabit-class signals and symbol rates exceeding 120 GBaud.

Each RF channel features variable gain amplifiers, controllable via software, to achieve optimized results over a wide input power range or fading channels



Weight

3 kg / 6.6 lbs.



Size of device

365 x 45 x 275mm
19" x 1.75" x 14.4"



Operating Temperature

10 to 35°C

PRODUCT VIDEO



BLOCK DIAGRAM

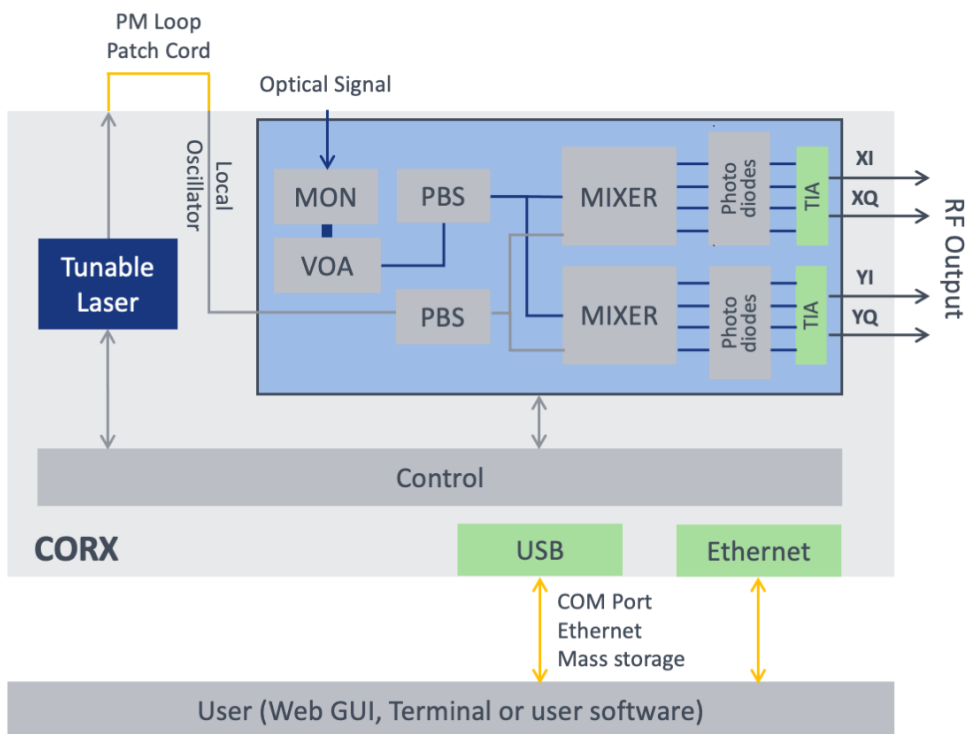

Invisible Laser Radiation
Class 1M Laser Product
EN 60825-1: IEC 60825-1

REFERENCE TEST RESULTS

CORX CLASS 60

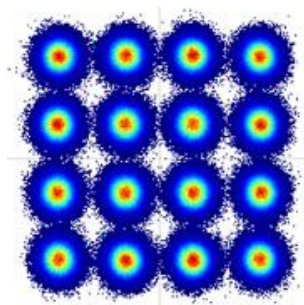
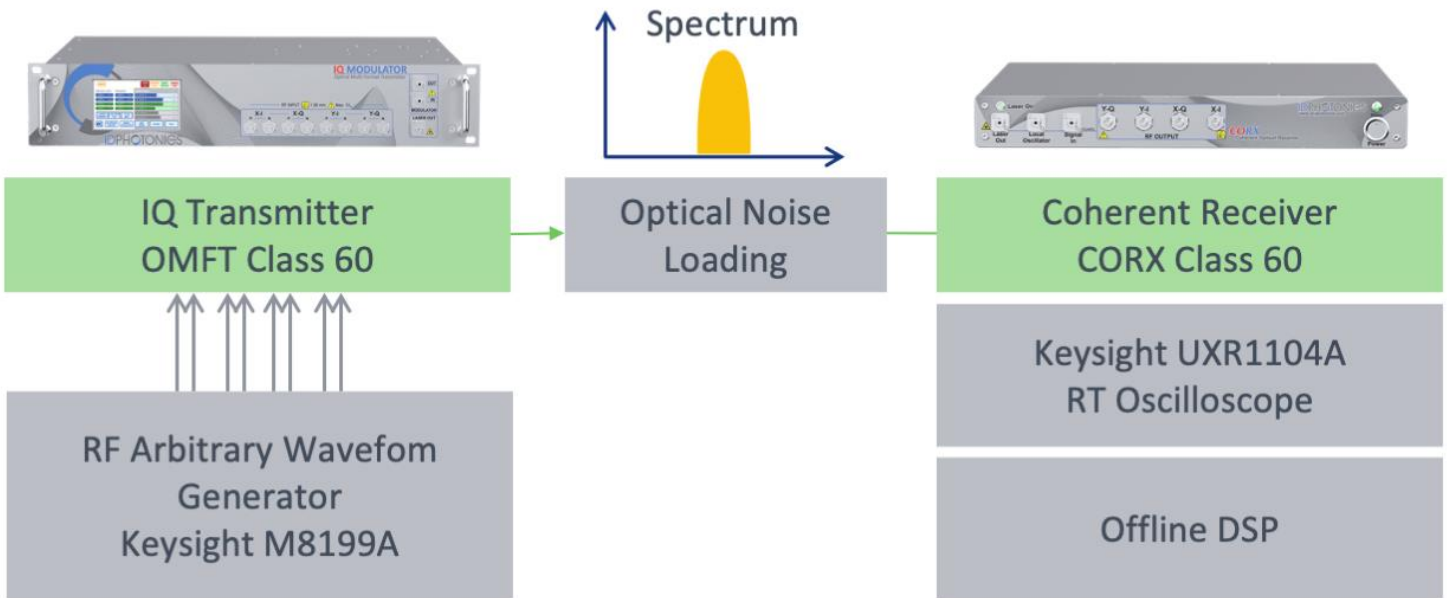

100GBd 16QAM - 800Gbit/s
EVM 9.45%

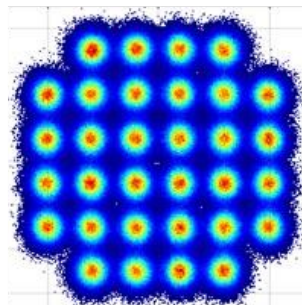

100GBd 32QAM - 1Tbit/s
EVM 10.5%

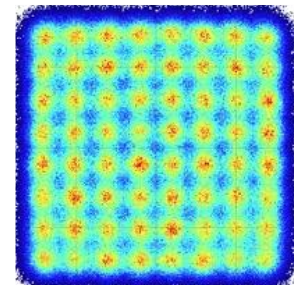

100GBd 64QAM - 1.2Tbit/s
EVM = 9.8%

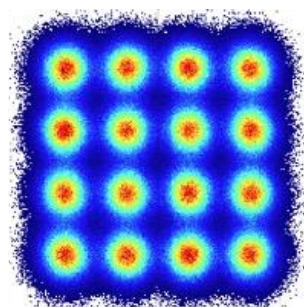

128GBd 16QAM - 1.024Tbit/s
EVM 15.56%

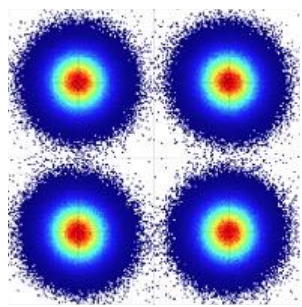

128GBd 4QAM - 512Gbit/s
EVM = 23.6%

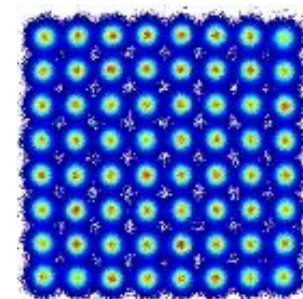

64GBd 64QAM - 768Gbit/s
EVM 5.5%

TYPICAL TRANSFER FUNCTIONS

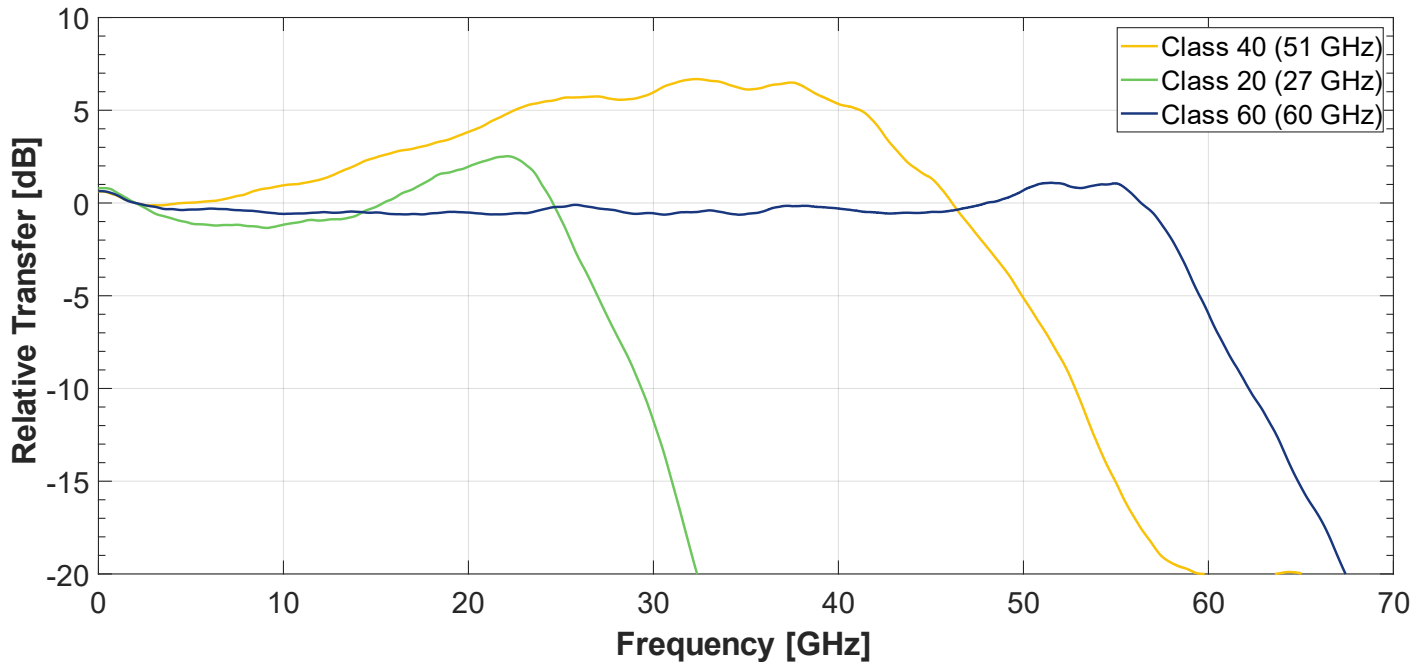

SPECIFICATION

DEVICE PARAMETER	CLASS 20 min/max	CLASS 40 min/max	CLASS 60 min/max
RF SPECIFICATION			
E/O BANDWIDTH, NORM. TO 1 GHz, -6 dB	18 GHz 25 GHz typical	38 GHz 40 GHz typical	55 GHz 60 GHz typical
LOW FREQUENCY CUTOFF, -3 dB	1 MHz		
RF OUTPUT SWING	600 milli-V _{pp}		
THD	5 %		
RF CMRR, AT SPECIFIED BANDWIDTH	-20 dBc		
DC COMMON MODE REJECTION RATIO, SIGNAL, LO	-20 dBc		
IQ SKEW	+/- 3 ps		
X Y SKEW	+/- 5 ps		
OUTPUT IMPEDANCE	50 Ohm		
ELECTRICAL OUTPUT RETURN LOSS	8 dB		
RF CONNECTORS, FEMALE	1.85 mm		
OPTICAL SPECIFICATION			
OPERATING WAVELENGTH RANGE	1528 – 1568 nm		
POLARIZATION EXTINCTION RATIO	17 dB		
OPTICAL RETURN LOSS @1550NM	27 dB		
PHASE ANGLE ERROR	+/- 5 deg		
RESPONSIVITY	0.035 A/W		
VOA ATTENUATION RANGE	10 dB		
OPTICAL CONNECTOR	FC/APC		
OPTICAL OPERATING CONDITIONS			
MAX. LO OPTICAL INPUT POWER	16 dBm		
MAX. SIGNAL INPUT POWER LEVEL	0 dBm		
ABSOLUTE MAXIMUM RATINGS			
MAX. OPTICAL INPUT POWER (LO + SIGNAL IN)	20 dBm		

SPECIFICATION

DEVICE PARAMETER	CLASS 20 min/max	CLASS 40 min/max	CLASS 60 min/max
DEVICE SPECIFICATION			
DIMENSIONS (W X H X D), W/O 19" ADAPTOR	365 x 45 x 275mm, 19 x 1.75 x 14.4 inch		
WEIGHT	3 kg, 6.6 lbs.		
ELECTRICAL POWER SUPPLY	100-240 VAC, 1A, 50/60Hz, 80 Watt, C13 connector		
OPERATING TEMPERATURE	+10 to +35°C, non-condensing		

SPECIFICATION: INTERNAL LASER

OPTICAL PARAMETER	SPECIFICATION	UNIT
FREQUENCY RANGE; C-BAND	190.70 – 196.65 (1524.5 - 1572nm)	THz
CHANNEL SPACING	Continuous	GHz
FREQUENCY FINE TUNE RESOLUTION	1	MHz
FREQUENCY FINE TUNE RANGE	+/- 6GHz	GHz
OPTICAL POWER RANGE, BEFORE MODULATOR PATH	10-16	dBm
SPECTRAL LINE WIDTH; 3DB INSTANTANEOUS, 3.5US (LORENTZIAN CONTRIBUTION)	< 100 25 typical	kHz
FREQUENCY ACCURACY OVER LIFETIME OVER 24 HOURS	+/- 1.5 +/- 0.3	GHz
SMSR; SIDE MODE SUPPRESSION RATIO	> 40 (50 typical)	dB
RIN (10MHZ TO 3GHZ) OUTPUT POWER ACCURACY OVER LIFETIME OVER 1 HOUR OVER 24 HOURS	< -145 (up to 40GHz) +/- 0.01 (typ.) +/- 0.03 (typ.)	dB/Hz dB dB
OUTPUT POWER SETTING RESOLUTION	0.01	dB
OPTICAL FIBER	Polarization- maintaining PANDA type Fiber, PER > 20dB, 25dB typ.	

CORX LASER TUNING METHODS

1

COARSE TUNING

Access the full specified tuning range and tune to any desired frequency.

2

FINE TUNING

Enables precise frequency adjustment by offsetting the coarse tuning set point within a small range.

TUNING MODES

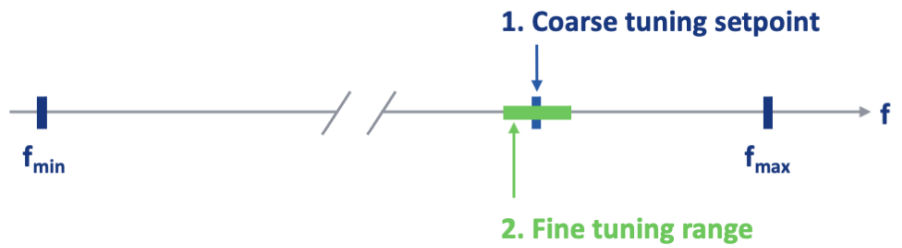

1. COARSE TUNING

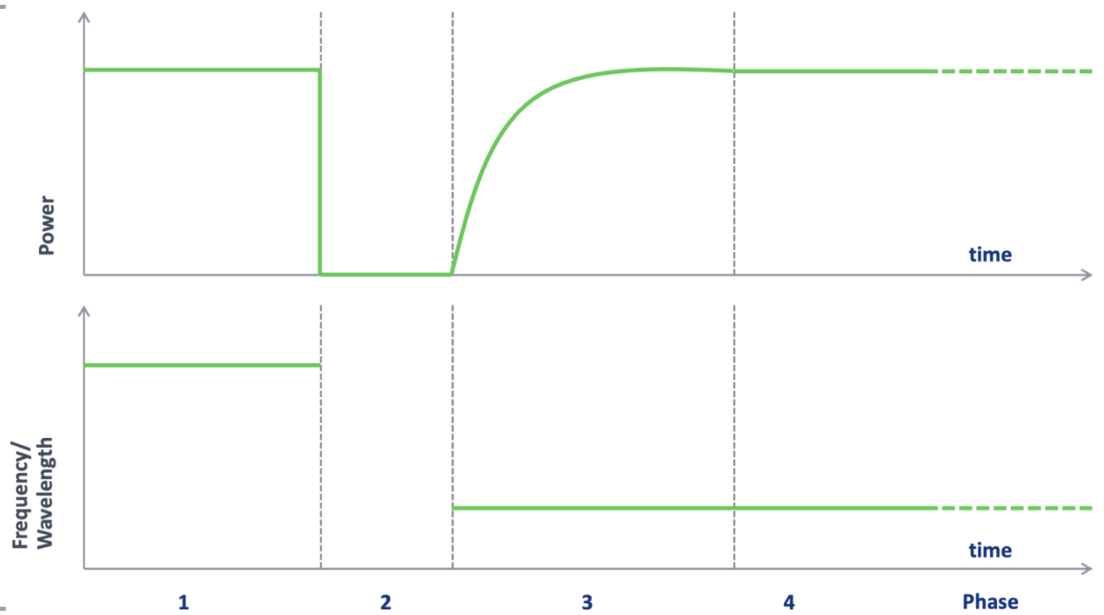

2. FINE TUNING

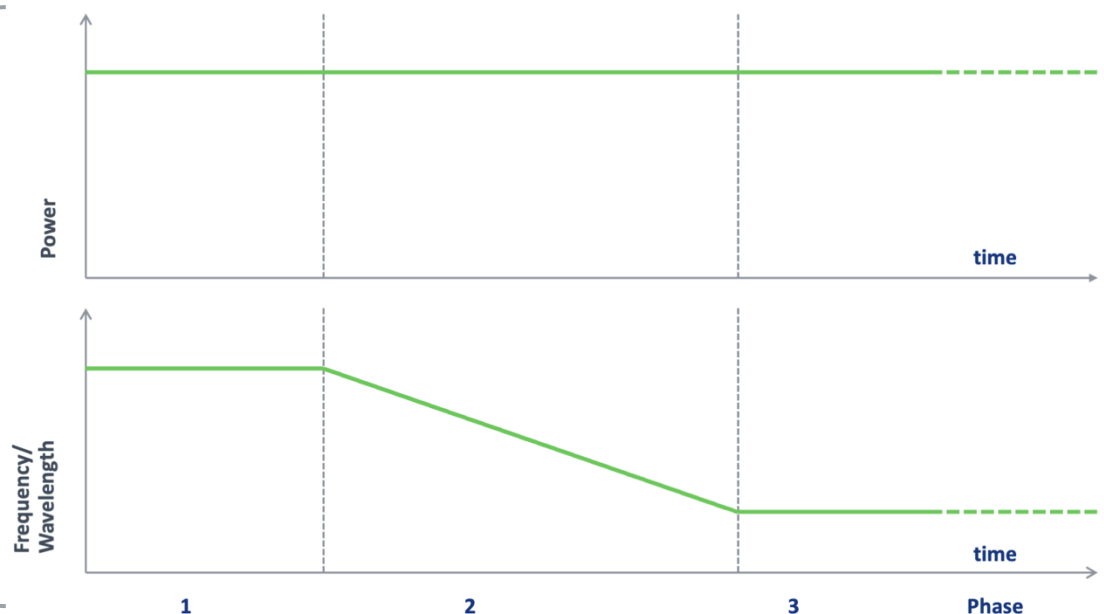

CONFIGURE CORX

1

PRODUCT

CO-RX-C-  -10 -FA

BANDWIDTH CLASS

- 20: Class 20
- 40: Class 40
- 60: Class 60



CLASS 20 / CLASS 40 / CLASS 60

KIT CONTAINS:

Device, Software, PM Patch cord , AC Power Cable, USB & Ethernet cable, Manual, Test Report

2

ACCESSORIES

CO-RX-ACC-RF-  -MM **RF CABLE SET, 1.85MM MALE-TO-MALE STRAIGHT SUITABLE FOR CORX CLASS 20, CLASS 40 AND CLASS 60**

- 03: Set of 4 pc RF cables, 30cm, +/-1ps delay matched, 1.85mm Male-to-Male straight, DC – 67GHz
- 06: Set of 4 pc RF cables, 60cm, +/-1ps delay matched, 1.85mm Male-to-Male straight, DC – 67GHz

CO-RX-ACC-RF-HB-  -MM **CABLE SET, HYBRID 1.85 MM “V-STYLE” TO 2.92MM “K-STYLE” CONNECTORS SUITABLE FOR CORX CLASS 20, CLASS 40 AND CLASS 60**

- 03: Hybrid RF Cables, CORX Accessory, Set of 4, 1.85mm Male to 2.92mm Male connectors, 50 Ohm Impedance, DC-40GHz, 30 cm, delay matched
- 06: Hybrid RF Cables, CORX Accessory, Set of 4, 1.85mm Male to 2.92mm Male connectors, 50 Ohm Impedance, DC-40GHz, 60 cm, delay matched

CO-RX-ACC-RM **MECHANICAL ADAPTOR KIT FOR 19" RACK MOUNT OF CORX DEVICE**



Invisible Laser Radiation
Class 1M Laser Product
EN 60825-1: IEC 60825-1



REQUEST A QUOTATION

Get in touch with us via info@id-photonics.com or send a request via our [web form](#).



SCAN ME

SHAPING LIGHT.

HELPING ENGINEERS AND SCIENTISTS IN
ADVANCING HOW THE WORLD COMMUNICATES,
SENSES AND CONNECTS

Copyright © 2024 ID Photonics GmbH. All rights reserved. No part of this publication may be reproduced, stored in a retrieval system or transmitted in any form, be it electronically, mechanically, or by any other means such as photocopying, recording or otherwise, without the prior written permission of ID Photonics GmbH.

Information provided by ID Photonics GmbH is believed to be accurate and reliable. However, no responsibility is assumed by ID Photonics GmbH for its use nor for any infringements of patents or other rights of third parties that may result from its use. No license is granted by implication or otherwise under any patent rights of ID Photonics GmbH.

The information contained in this publication is subject to change without notice.

ID PHOTONICS GMBH

Anton-Bruckner-Straße 6
85579 Neubiberg
GERMANY

Tel: +49-89-201 899 16
info@id-photonics.com