

SHAPING LIGHT.

HELPING ENGINEERS AND SCIENTISTS IN
ADVANCING HOW THE WORLD COMMUNICATES,
SENSES AND CONNECTS



**OMFT – OPTICAL MULTI-FORMAT TRANSMITTER
REFERENCE DUAL POLARIZATION IQ TRANSMITTER
DATA SHEET**

REFERENCE DUAL POLARIZATION IQ TRANSMITTER

The Optical Multi-Format Transmitter (OMFT) instrument series is a fully integrated, turnkey optical frontend that converts differential electrical RF signals into Dual-Polarization IQ modulated optical signals.

It supports next-gen multi-level transmission formats at high symbol rates up into the Terabit per second domain.

With its integrated RF Amplifiers, it is an ideal companion for state-of-the-art Arbitrary Waveform Generators supporting differential drive for maximum performance at state-of-the-art bandwidths up to 80 GHz.

Our in-house developed automated BIAS control is completely RF-amplitude and modulation format independent, allowing users to apply customized RF input signals without manual tweaking.

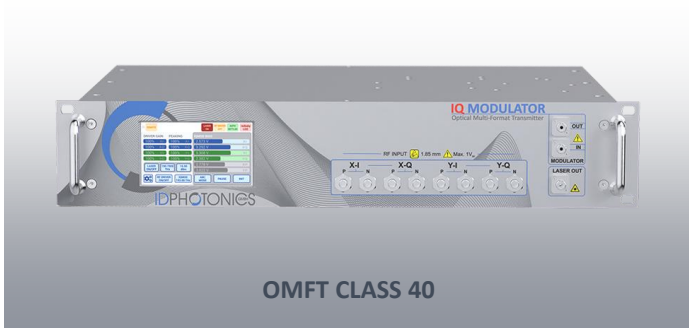

OMFT CLASS 40

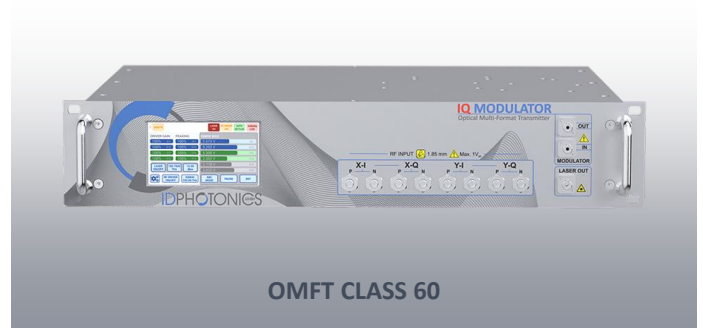

OMFT CLASS 60



OMFT CLASS 80

KEY FEATURES

- High-bandwidth single & dual-pol optical IQ modulation, beyond 80 GHz E/O bandwidth
- Supports fast and simple switching between modulation formats applied by the signal source
- Differential RF drive for maximum performance
- Integrated tunable laser source
- Full remote control capability via SCPI interface
- Add-on to electrical AWG
- Device specific calibration files enable software-based pre-distortion
- USB & Ethernet interface for remote control

TYPICAL APPLICATIONS

- Generation of advanced optical modulation formats (e.g. QPSK, 16-QAM, ...)
- Reference transmitter
- Testing coherent optical receivers
- Multi-channel transmission experiments for system design tests

WHAT DIFFERENTIATES OUR OMFT SOLUTION AND DRIVES SUCCESS



IN-HOUSE DEVELOPED BIAS CONTROL

We are proud to offer a fully in-house developed Automatic BIAS Control system, refined over 10 years of development, that sets us apart from the competition.



ULTRA-PRECISE ABS CONTROL

Our unique BIAS control system does not rely RF feedback signals derived from the data signal to control the IQ Mach-Zehnder structures. Instead, it uses internally generated feedback signals to identify and track the optimal BIAS setting



ZERO NOISE FEATURE

This feature will mute signals used for the automatic BIAS control and freeze its current status achieving optimum performance.



SIMPLE, INTUITIVE USABILITY

A comprehensive GUI allows setting up, control and monitoring the unit within minutes. Remote control via Ethernet or USB gives a maximum of flexibility connecting to the board.



OMFT IS FLEXIBLE

Utilize the integrated tunable laser when required, and easily switch to your external light source when it's not needed. If the tunable laser isn't being used for the OMFT, it can serve as a versatile general-purpose light source.

DESIGNED & MADE IN GERMANY

Blends innovation and precision to ensure success

German craftsmanship is renowned worldwide for its meticulous attention to detail and use of high-quality materials.

It signifies a commitment to exceptional quality and precision engineering.

At ID Photonics, our entire operations are based in Germany, ensuring top-notch craftsmanship. We handle everything from manufacturing and hardware design to software and circuit design. This comprehensive approach guarantees products that are reliable, durable, and innovative. By choosing ID Photonics, you invest in engineering excellence and timeless design, all crafted with meticulous attention to detail in Germany.

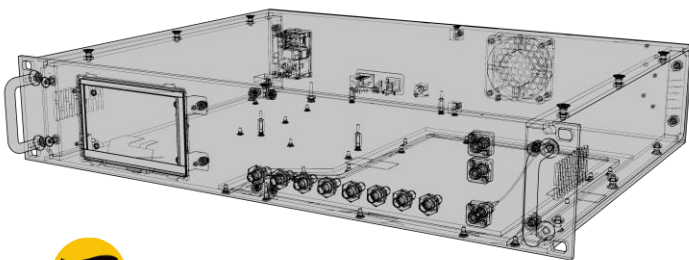

**DESIGNED & MADE
IN GERMANY**

SIMPLE, INTUITIVE CONTROL OF YOUR OMFT

The OMFT comes with an intuitive and easy-to-use graphical user interface (GUI) that requires no installation. It's designed to provide a seamless experience, allowing you to control and monitor the laser with ease.

- **Simplicity at Its Best:** Say goodbye to complex installations and hello to instant control. Our OMFT features an embedded graphical user interface (GUI) that requires no additional software. Just connect, and you're ready to operate
- **Intuitive Design:** Navigate with ease through our clean and modern dashboard. Monitor real-time performance, adjust settings, and ensure safety with just a few clicks
- **Plug-and-Play Convenience:** Start using your laser system right out of the box. Connect via USB or Ethernet, open your web browser, and take control through the built-in interface
- **Instant Local Control:** The unit can be operated using the modern touch panel display at the front, eliminating the need for any external devices



1

OMFT - WEB GUI ON TABLET

2

OMFT - WEB GUI ON DESKTOP

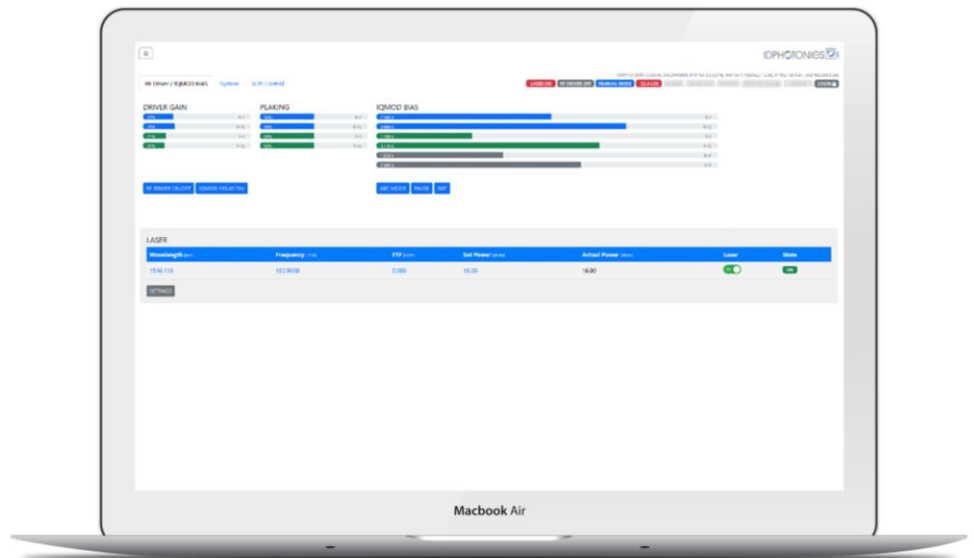

3

OMFT - TOUCH GUI ON PRODUCT



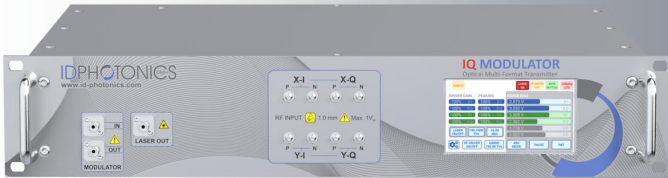

REFERENCE IQ TRANSMITTER

OMFT CLASS 80

The Class 80 unit features 1 mm RF connectors, supporting signals up to 80 GHz and delivering performance for symbol rates up to 160 GBaud.

The unit comes with per-channel user-tunable RF gain and peaking feature.

Additionally, it incorporates internal optical amplifiers to minimize the insertion loss typically associated with modulating multi-level signals on Mach-Zehnder devices.



Weight

5.2 kg / 11.5 lbs.



Size of device

483 x 90 x 344 mm
19" x 3.6" x 13.5"



Operating Temperature

10 to 35°C

PRODUCT VIDEO



Invisible Laser Radiation
Class 1M Laser Product
EN 60825-1: IEC 60825-1

BLOCK DIAGRAM

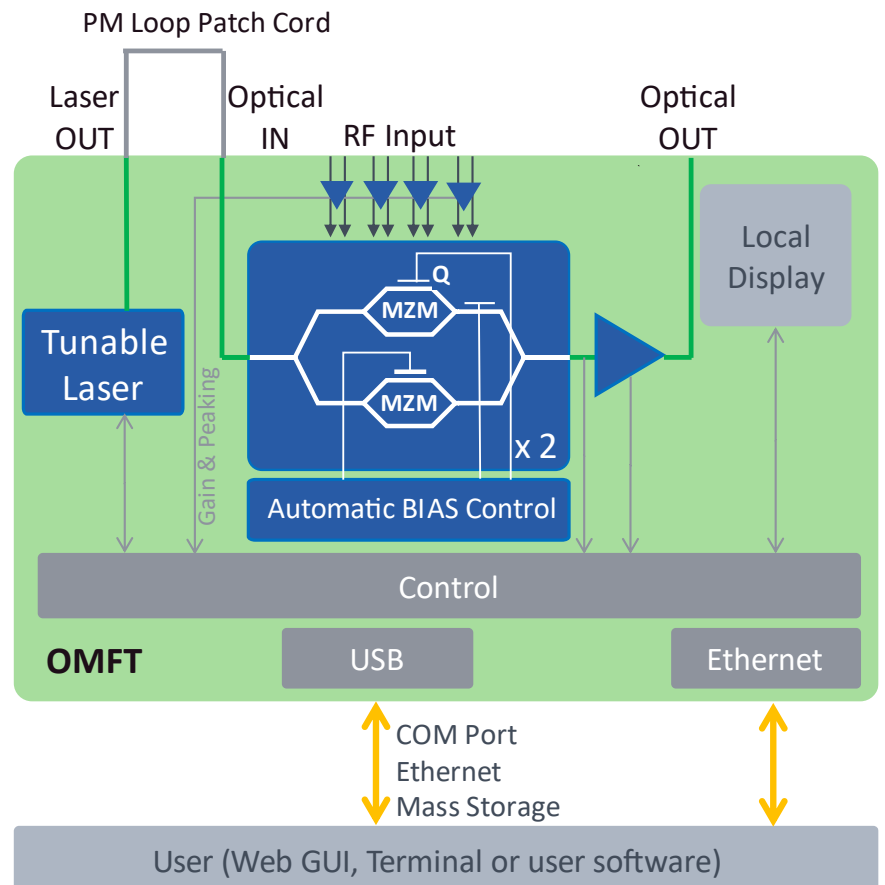



REFERENCE IQ TRANSMITTER

OMFT CLASS 40 AND 60

The Class 40 and Class 60 share the same architecture and properties, featuring 1.85 mm differential RF inputs.

The Class 40 offers typical bandwidths up to 45 GHz, supporting symbol rates up to 96 GBaud.

In contrast, the Class 60 extends its capabilities to 60 GHz E/O bandwidth and 120 GBaud.

Both devices come with per-channel tunable RF gain and peaking.



Weight

4.5 kg / 9.9 lbs



Size of device

483 x 90 x 275 mm
19" x 3.6" x 10.9"



Operating Temperature

10 to 35°C

PRODUCT VIDEO



Invisible Laser Radiation
Class 1M Laser Product
EN 60825-1: IEC 60825-1

BLOCK DIAGRAM

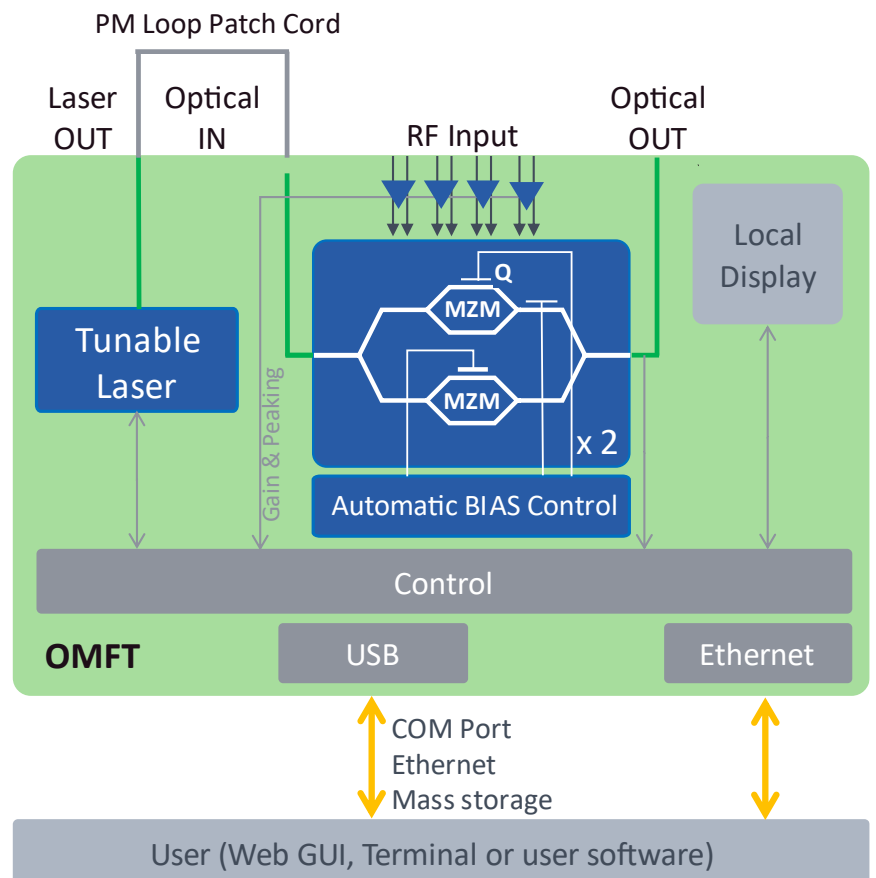

REFERENCE TEST RESULTS

OMFT CLASS 80

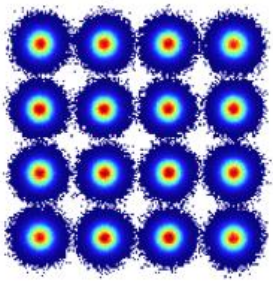
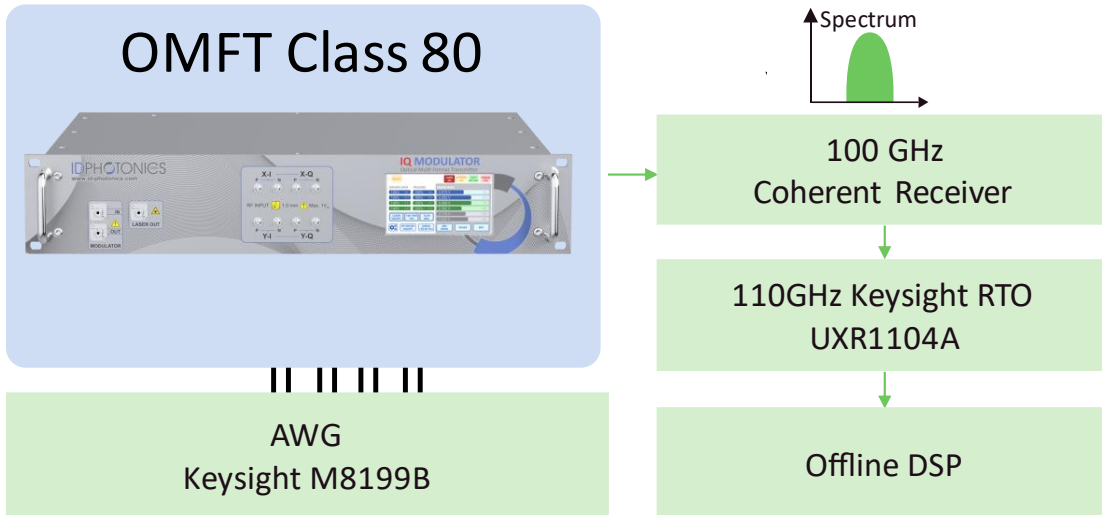

128 GBd 16QAM – 1.02 TBit/s
EVM 8.5%

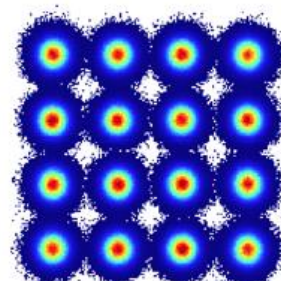

140 GBd 16QAM – 1.12 TBit/s
EVM 9.5%

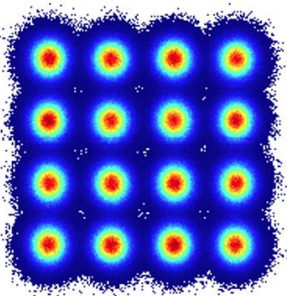

170 GBd 16QAM – 1.36 TBit/s
EVM 12.2%

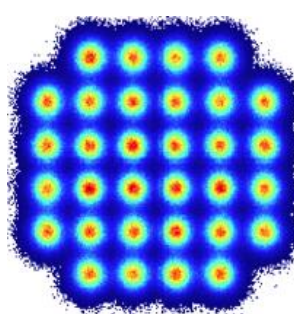

160 GBd 32QAM – 1.6 TBit/s
EVM 11.5%

The reference results provided are typical and may vary according to the specific system configuration

REFERENCE TEST RESULTS

OMFT CLASS 60

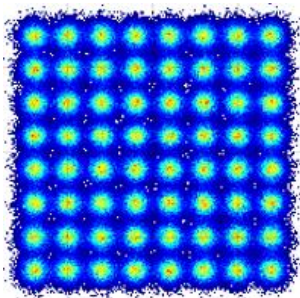
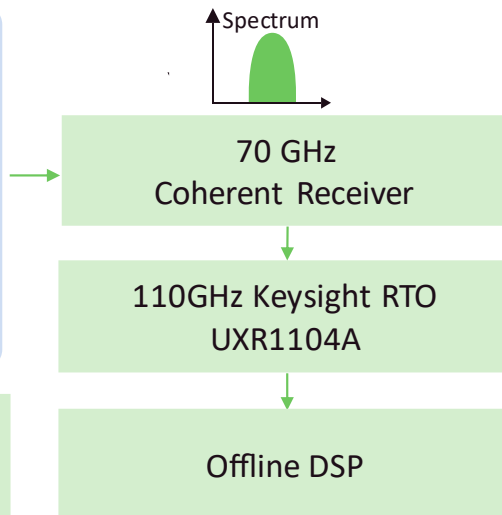

M8199A

110 GBd 64QAM – 1.32 TBit/s
EVM 6.3%

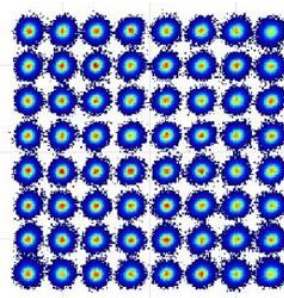

M8194A

64 GBd 64QAM - 768 GBit/s
EVM 3.8%

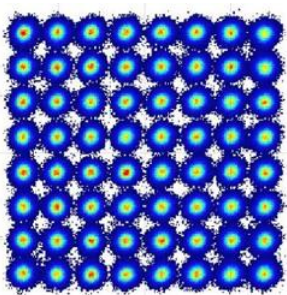

M8194A

80 GBd 64QAM - 960 GBit/s
EVM 4.4%

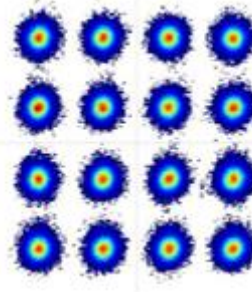

M8194A

96 GBd 16QAM – 768 GBit/s
EVM 6.8%

Setup using M8194A is bandwidth limited by AWG

The reference results provided are typical and may vary according to the specific system configuration

REFERENCE TEST RESULTS

OMFT CLASS 40

OMFT Class 40



120 GSa/s AWG
Keysight M8194A

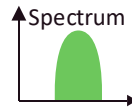

70 GHz
Coherent Receiver

110GHz Keysight RTO
UXR1104A

Offline DSP

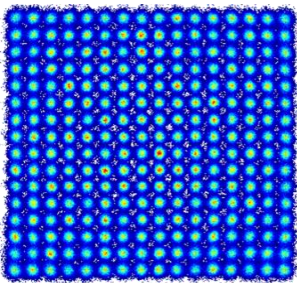

40 GBd 256QAM - 640 GBit/s
EVM 2.9%

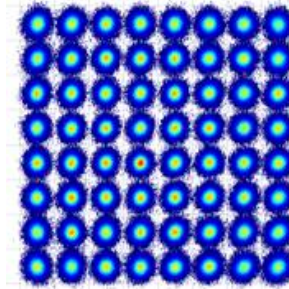

64G GBd 64QAM - 768 GBit/s
EVM 4.0%

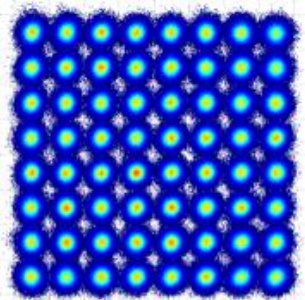

80 GBd 64QAM - 960 GBit/s
EVM 4.9%

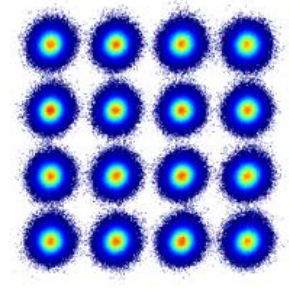

96 GBd 16QAM - 768 GBit/s
EVM 7.9%

The reference results provided are typical and may vary according to the specific system configuration

TYPICAL TRANSFER FUNCTIONS OF IQ MODULATOR CLASS 80

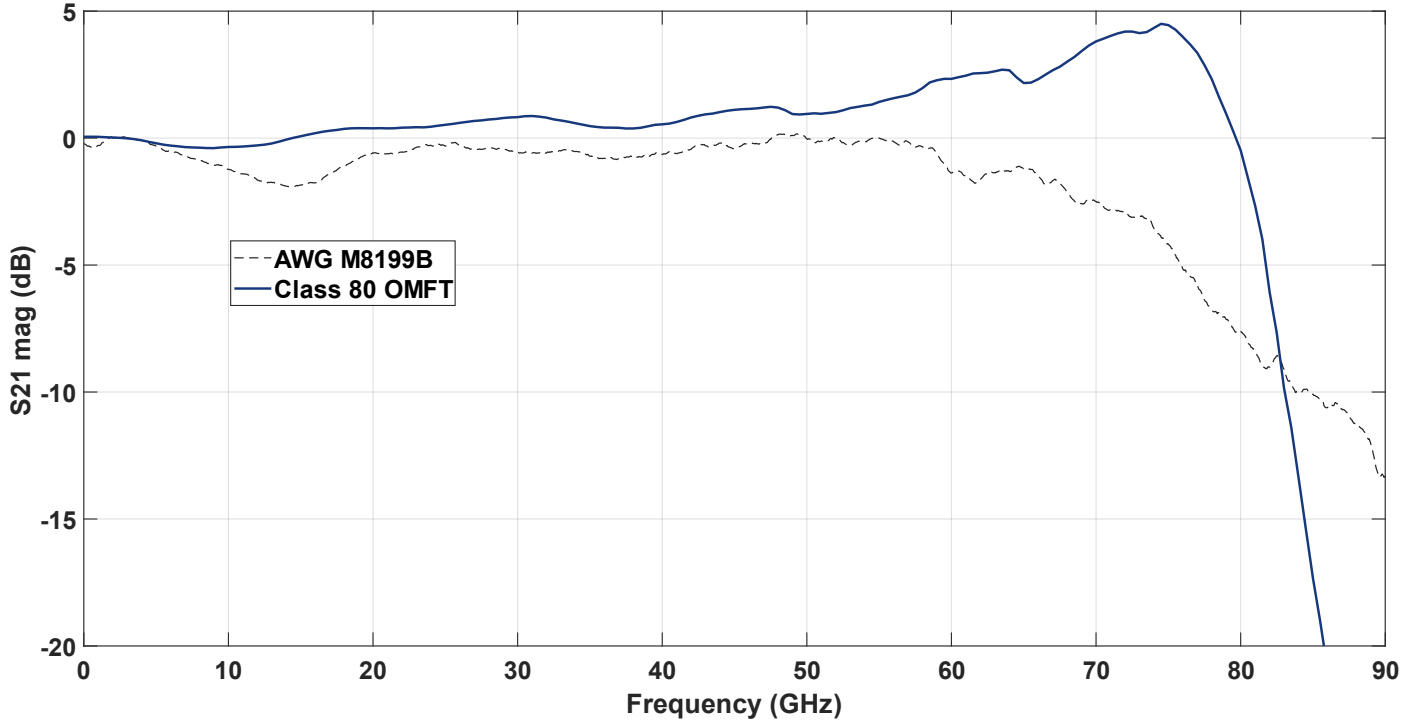

CLASS 40 AND CLASS 60

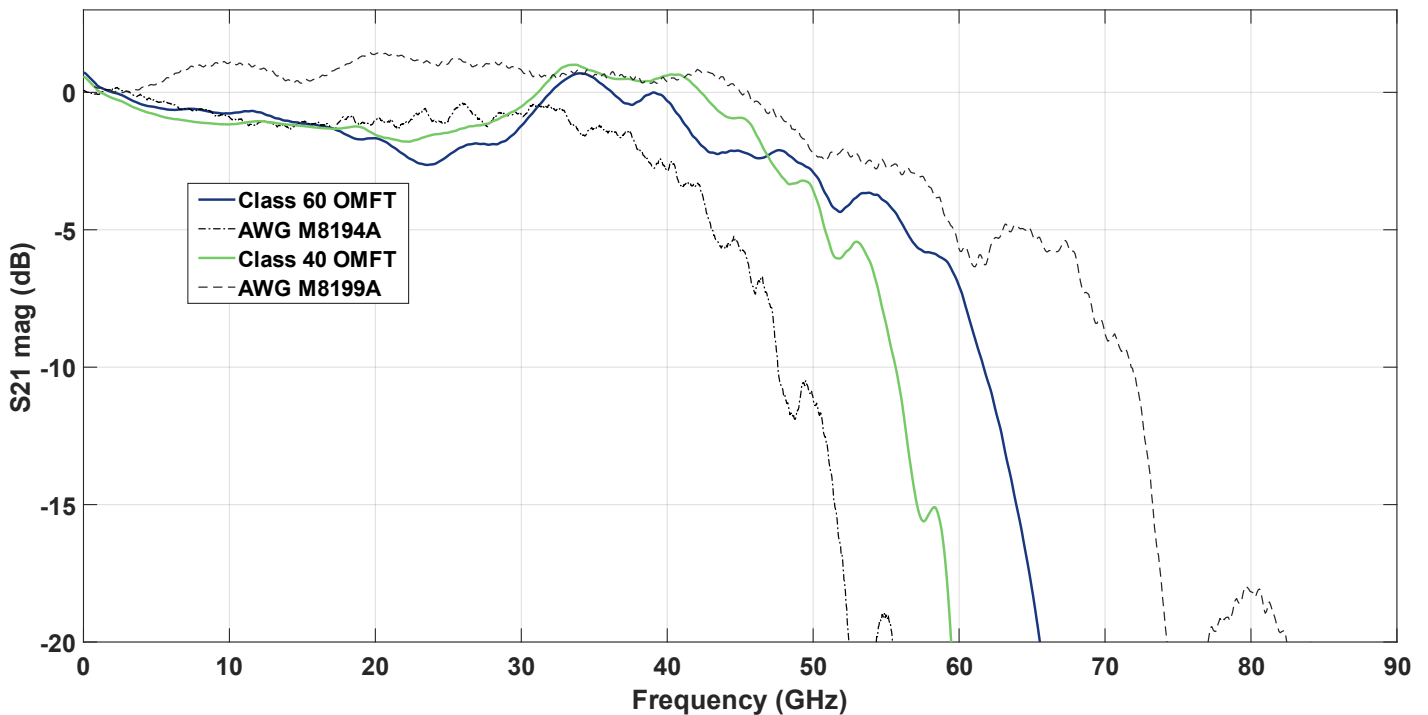

AWG transfer curves include RF cabling to OMFT

SPECIFICATION

DEVICE PARAMETER	CLASS 40	CLASS 60	CLASS 80
RF SPECIFICATION			
E/O BANDWIDTH 3 dB [GHz] 6 dB	35, typical 40 > 40, typical 47 (30% gain setting)	35, typical 40 > 53, typical 58 (70% gain setting)	- > 80, typical 82 (50% gain setting)
GAIN IMBALANCE	< 1 dB, variable adjustment available using per-channel RF gain control		
TYPICAL RF INPUT VOLTAGE	250 mVpp	250 mVpp	300 mVpp
E/O SKEW I & Q	+/-2 ps		0 to 20 ps, characterized per device
LOW FREQUENCY CUT-OFF	1 MHz		4 MHz
RF DIFFERENTIAL INPUT IMPEDANCE	100 Ohm		
OPTICAL SPECIFICATION			
OPERATING WAVELENGTH RANGE	1525 – 1570 nm 191.1 – 196.25 THz		
XY POLARIZATION IMBALANCE	< 1 dB		
DC EXTINCTION RATIO	> 30 dB, no RF applied, Class 80: not applicable		
IQ OFFSET	< -20 dB		
INSERTION LOSS	< 12 dB, (maximum transmission point setting, no RF modulation)		not applicable
TYPICAL OUTPUT POWER UNDER MODULATION	-13 to -10 dBm, Tx Laser @16dBm, modulation on both polarizations		-3 to -0 dBm, Tx Laser @13dBm, modulation on both polarizations
QUADRATURE ERROR	averaged mean +/-0.5 deg, 99% confidence in >4hrs < +/- 5 deg		
STARTUP TIME OF AUTOMATIC BIAS CONTROL	< 3 Minutes, 1 Minute typical (until settled)		
INPUT POWER LOCKING RANGE OF BIAS CONTROL	9 – 18 dBm @Modulator Input		
ABSOLUTE MAXIMUM RATINGS			
MAX. OPTICAL INPUT POWER	+18 dBm @ OMFT Modulator Input Port, Class 80 recommend power: 13-14 dBm Input power		
MAXIMUM ELECTRICAL INPUT VOLTAGE, AC	1000 mVpp (@ RF input connectors of OMFT, no DC component)		
MAXIMUM ELECTRICAL INPUT VOLTAGE, DC	+/- 500 mVpp (@ RF input connectors of OMFT, no DC component)		

SPECIFICATION

DEVICE PARAMETER	CLASS 40	CLASS 60	CLASS 80
PHYSICAL DEVICE SPECIFICATION			
OPTICAL IN-/OUTPUT CONNECTOR	FC/APC		
OPTICAL FIBER	Laser out and Modulator Input Port: PM PANDA type Fiber, PER > 20 dB, 25 dB typ. Modulator Output Port: ITU-T G.652.D, SSMF		
ELECTRICAL RF CONNECTORS	1.85 mm, female, differential		1.00 mm, female, differential
OPERATING TEMPERATURE	10 to 35°C non-condensing		
SIZE OF DEVICE (H X W X D)	483 x 90 x 275 mm (19 x 3.6 x 10.9 inch)		483 x 90 x 344 mm (19 x 3.6 x 13.5 inch)
WEIGHT	4.5 kg / 9.9 lbs.		5.2 kg / 11.5 lbs.
POWER SUPPLY	100-240 VAC, 1A, 50/60Hz, 80 Watt		

SPECIFICATION: INTERNAL LASER

OPTICAL PARAMETER	SPECIFICATION	UNIT
FREQUENCY RANGE; C-BAND	190.70 – 196.65 (1524.5 - 1572nm)	THz
CHANNEL SPACING	Continuous	GHz
FREQUENCY FINE TUNE RESOLUTION	1	MHz
FREQUENCY FINE TUNE RANGE	+/- 6 GHz	GHz
OPTICAL POWER RANGE, BEFORE MODULATOR PATH	10-16	dBm
SPECTRAL LINE WIDTH; 3DB INSTANTANEOUS, 3.5US (LORENTZIAN CONTRIBUTION)	< 100 25 typical	kHz
FREQUENCY ACCURACY OVER LIFETIME OVER 24 HOURS	+/- 1.5 +/- 0.3	GHz
SMSR; SIDE MODE SUPPRESSION RATIO	> 40 (50 typical)	dB
RIN (10MHZ TO 3GHZ) OUTPUT POWER ACCURACY OVER LIFETIME OVER 1 HOUR OVER 24 HOURS	< -145 (up to 40 GHz) +/- 0.01 (typ.) +/- 0.03 (typ.)	dB/Hz dB dB
OUTPUT POWER SETTING RESOLUTION	0.01	dB
OPTICAL FIBER	Polarization- maintaining PANDA type Fiber, PER > 20dB, 25dB typ.	

OMFT LASER TUNING METHODS

1

COARSE TUNING

Access the full specified tuning range and tune to any desired frequency.

2

FINE TUNING

Enables precise frequency adjustment by offsetting the coarse tuning set point within a small range.

TUNING MODES

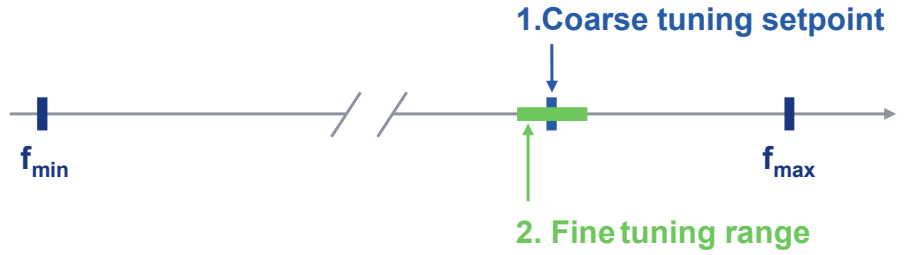

1. COARSE TUNING

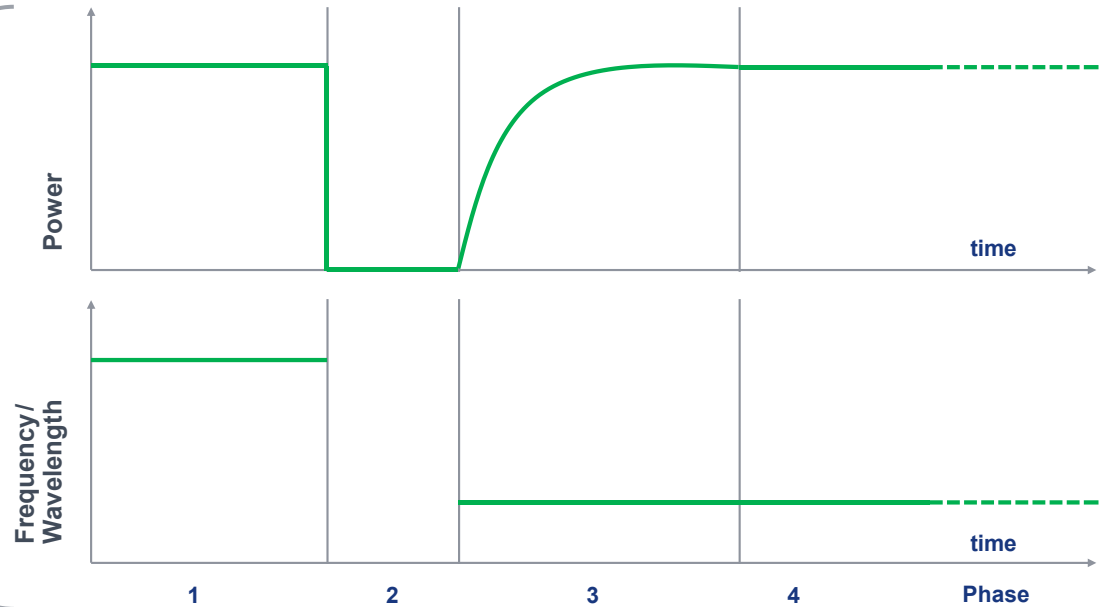

2. FINE TUNING

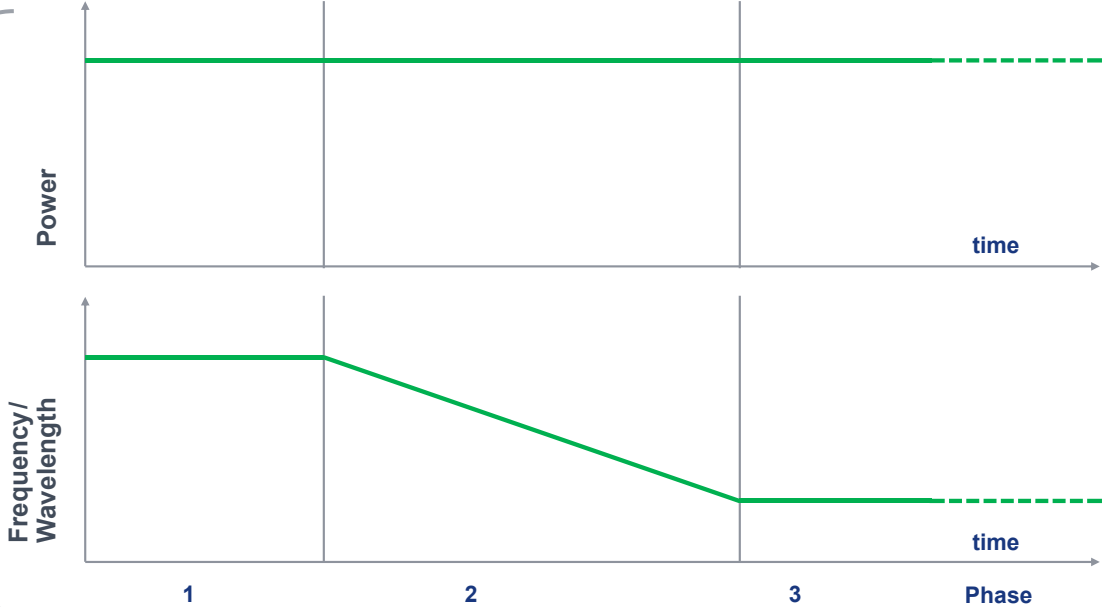

CONFIGURE OMFT

1

CLASS

OMFT-C-  -FA

- PRODUCT:**
 00: Class 40
 01: Class 60
 02: Class 80



CLASS 40 / CLASS 60



CLASS 80

2

ACCESSORIES

OMFT-ACC-RF-  -MM

CABLE SET, 1.85 MM "V-STYLE" CONNECTORS SUITABLE FOR CLASS 40 & 60 OMFT

- 03: 8 pc RF cables 30 cm, +/-1 ps delay matched, 1.85 mm Male-to-Male straight, 50 Ohm, DC – 67GHz
 06: 8 pc RF cables 60 cm, +/-1 ps delay matched, 1.85 mm Male-to-Male straight, 50 Ohm, DC – 67GHz

OMFT-ACC-RF-HB-  -MM

CABLE SET, HYBRID 1.85 MM "V-STYLE" TO 2.92MM "K-STYLE" CONNECTORS SUITABLE FOR CLASS 40 & 60 OMFT

- 03: Hybrid RF Cables, OMFT Accessory, Set of 8, 1.85mm Male to 2.92mm Male connectors, 50 Ohm Impedance, DC-40GHz, 30 cm, delay matched
 06: Hybrid RF Cables, OMFT Accessory, Set of 8, 1.85mm Male to 2.92mm Male connectors, 50 Ohm Impedance, DC-40GHz, 60 cm, delay matched

OMFT80-ACC-RF-  -MM

CABLE SET, 1.00 MM CONNECTORS SUITABLE FOR CLASS 80 OMFT ONLY

- 15: RF Cables, OMFT Accessory, Set of 8, 1.00 mm connectors Male-to-Male, 50 Ohm Impedance, DC - 100 GHz, 15 cm, delay matched
 30: RF Cables, OMFT Accessory, Set of 8, 1.00 mm connectors Male-to-Male, 50 Ohm Impedance, DC - 100 GHz, 30 cm, delay matched

OMFT80-ACC-TERM-1MM

TERMINATION, 50 OHM, 1 MM MALE, 0 TO 100 GHZ, 1 PIECE



Invisible Laser Radiation
 Class 1M Laser Product
 EN 60825-1: IEC 60825-1



REQUEST A QUOTATION

Get in touch with us via info@id-photonics.com or send a request via our [web form](#).



SCAN ME

SHAPING LIGHT.

HELPING ENGINEERS AND SCIENTISTS IN
ADVANCING HOW THE WORLD COMMUNICATES,
SENSES AND CONNECTS

Copyright © 2024 ID Photonics GmbH. All rights reserved. No part of this publication may be reproduced, stored in a retrieval system or transmitted in any form, be it electronically, mechanically, or by any other means such as photocopying, recording or otherwise, without the prior written permission of ID Photonics GmbH.

Information provided by ID Photonics GmbH is believed to be accurate and reliable. However, no responsibility is assumed by ID Photonics GmbH for its use nor for any infringements of patents or other rights of third parties that may result from its use. No license is granted by implication or otherwise under any patent rights of ID Photonics GmbH.

The information contained in this publication is subject to change without notice.

ID PHOTONICS GMBH

Anton-Bruckner-Straße 6
85579 Neubiberg
GERMANY

Tel: +49-89-201 899 16
info@id-photonics.com