



## COBRITE DX, DX2, MX SERIES TUNABLE LASER INSTRUMENT SERIES

### USER MANUAL



COBRITE DX



COBRITE DX2



COBRITE MX

Status: 2024-03-20  
Applies to Firmware 1.4.2 or later

info@id-photonics.com  
id-photonics.com

# CONTENT

1	General Information	3
2	CoBrite DX Series - Unit Overview – Operating principle and block diagram	8
3	CoBrite MX Series - Unit Overview – Operating principle and block diagram	14
4	Quick Start – Remote Control	18
5	Getting Started – All units	19
6	Description of front panel operation – CoBrite DX only	25
7	Description of instrument operation using the Web GUI – All devices	30
8	Remote Control – All devices	35

# 1 GENERAL INFORMATION

## 1.1 WARNING LASER SAFETY

The laser sources specified by this user guide are classified according to IEC 60825-1 (2007) Laser Notice No. 50 dated 2007-June-24 and comply with CFR 1040.10 except deviations per Laser Notice No. 50, July 2001 Key Feature Number 4.

This device is a Class 1M laser product for use only under the recommended operating conditions and ratings specified in this document. Use of controls or adjustments or performance of procedures other than these specified in this product datasheet may result in hazardous radiation exposure.

Do not view the laser output from this device directly with optical instruments (e.g., eye loupes, magnifiers, microscopes). Viewing the laser output with certain optical instruments within a distance of 100mm may pose an eye hazard. The class 1M laser product definition is based on all conditions defined in this section.

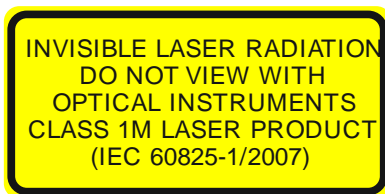

Please pay attention to the following laser safety warning: Under no circumstances look into the end of an optical cable attached to the optical output when the device is operational. The laser radiation can seriously damage your eyesight. Do not enable the laser when there is no fiber attached to the optical output connector. The laser is enabled by pressing the 'Laser on' button in the operating software delivered with the instrument. The laser is on when the red LED on the front panel of the instrument is lit. The use of optical instruments with this product will increase eye hazard.

In doubt about laser safety requirements consult a trained laser safety instructor for local safety requirements of this product.

## 1.2 COMPLIANCE STATEMENT ELECTROMAGNETIC COMPATIBILITY AND DEVICE SAFETY

Hereby, we declare that this system has been designed and tested for compliance for the following directives.

### 1.2.1 INTERNATIONAL

IEC 62368-1

CISPR 11:2003 in accordance with EN 61326-1: 2006

### 1.2.2 UNITED STATES OF AMERICA

FCC 47 CFR Part 15, Subpart B Class A, Measurement process ANSI C63.4 (2009)

### 1.2.3 EUROPEAN UNION

EN 55022:2011

EN 61326-1: 2013

EN 61000-6-2: 2006

EN 61000-6-4: 2011

EN 61000-3-2: 2010

EN 61000-3-3: 2009

This conformity statement for includes EU directive 2002/95/EG (RoHS) and EU directive EG1907/2006 (REACH).

## 1.3 LIMITATION OF COMMUNICATION INTERFACES

Operation of all USB Ports is limited to a maximum cable length of 3m and a maximum length of 30m for all Ethernet ports present.

## 1.4 EUROPEAN WEEE DIRECTIVE COMPLIANCE

ID PHOTONICS has established processes in compliance with the Waste Electrical and Electronic Equipment (WEEE) Directive, 2002/96/EC. This product should not be disposed of as unsorted municipal waste and should be collected separately and disposed of according to your national regulations. In the European Union, all equipment purchased from ID PHOTONICS can be returned for disposal at the end of its useful life. ID PHOTONICS will ensure that all waste equipment returned is reused, recycled, or disposed of in an environmentally friendly manner, and in compliance with all applicable national and international waste legislation. It is the responsibility of the equipment owner to return the equipment to ID PHOTONICS for appropriate disposal. If the equipment was imported by a reseller whose name or logo is marked on the equipment, then the owner should return the equipment directly to the reseller. If you have questions concerning disposal of your equipment, contact ID PHOTONICS's at [WEEE@id-photonics.com](mailto:WEEE@id-photonics.com).

## 1.5 LINE VOLTAGE SELECTION

CoBrite DX and CoBrite MX chassis operate from any single-phase AC power source that supplies 100 ~ 240VAC at a frequency at 50/60 Hz. The input line voltage setting is done automatically by CoBrite power supply. The CoBrite DX2 device itself does not have an integrated AC power supply but uses an external AC/DC supply that provides 12VDC to the chassis. This external supply operates from any single-phase AC power source that supplies 100 ~ 240VAC at a frequency at 50/60 Hz. The input line voltage setting is done automatically by the external power supply. Do only use the provided power supply to power the Cobrite device.

## 1.6 SERVICE

Do not attempt to service or adjust this instrument unless an authorized person is present. Do not install substitute parts or perform any unauthorized modifications to this instrument. Contact ID Photonics or your local distributor to obtain service support.

## 1.7 HELP AND USER FEEDBACK

ID Photonics GmbH is dedicated to continuously improve customer experience of our products. Thus, if you have any feedback that might help us to improve our products send us an E-Mail to: [feedback@id-photonics.com](mailto:feedback@id-photonics.com)

## 1.8 OPTICAL OUTPUT OF LASER PORTS

Each laser port features a polarization maintaining Fiber output which can be both used with standard single mode fibers and polarization maintaining fibers. The emitted E-field is oriented along the slow axis of the fiber.

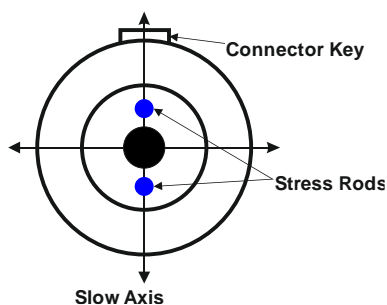

## 1.9 SAFETY

### 1.9.1 GENERAL SAFETY PRECAUTIONS

The following general safety precautions must be observed during all phases of operation of this instrument. Failure to comply with these precautions or with specific warnings elsewhere in this manual violates safety standards of design, manufacture, and intended use of the instrument.

**ID Photonics assumes no liability for the customer's failure to comply with these requirements.**

Before operation, review the instrument and manual for safety markings and instructions. You must follow these to ensure safe operation and to maintain the instrument in safe condition.

### 1.9.2 GENERAL

This product is a Safety Class 1 instrument (all units except CoBrite DX2, provided with a protective earth terminal). The protective features of this product may be impaired if it is used in a manner not specified in the operation instructions.

The CoBrite DX2 chassis does not connect to AC power outlets but solely operates from 12V (low voltage) external AC power supply.

### 1.9.3 ENVIRONMENTAL CONDITIONS

This instrument is intended for indoor use in an installation category II, pollution degree 2 environments. It is designed to operate at a maximum relative humidity of 95% and at altitudes of up to 2000 meters.

Refer to the specification tables for the ac mains voltage requirements and ambient operating temperature range.

### NOTE

Before connecting electrical power to the unit, make sure the unit could acclimatize to ambient temperature for at least 2 hours to avoid damage by i.e. condensed humidity on electrical parts inside the unit.

### 1.9.4 FUSE REPLACEMENT

For continued protection against the possibility of fire, replace the fuse only with a fuse of the specified voltage, current and type ratings.

### 1.9.5 BEFORE APPLYING POWER

Verify that all safety precautions are taken. The power cable inlet of the instrument serves as a device to disconnect from the mains in case of hazard. The instrument must be positioned so that the operator can easily access the power cable inlet. When the instrument is rack mounted the rack must be provided with an easily accessible mains switch.

### 1.9.6 MAXIMUM RATINGS

ALWAYS operate the unit within the maximum ratings. Ignoring these limits may result in permanent damage to the unit and loss of warranty.

### 1.9.7 GROUND THE INSTRUMENT

(This section does not apply to CoBrite DX2 type chassis)

To minimize shock hazard, the instrument chassis and cover must be connected to an electrical protective earth ground. The instrument must be connected to the ac power mains through a grounded power cable, with the ground wire firmly connected to an electrical ground (safety ground) at the power outlet. Any interruption of the protective (grounding) conductor or disconnection of the protective earth terminal will cause a potential shock hazard that could result in personal injury.

### 1.9.8 DO NOT OPERATE IN AN EXPLOSIVE ATMOSPHERE

Do not operate the instrument in the presence of flammable gases or fumes.

### 1.9.9 DO NOT REMOVE THE INSTRUMENT COVER

Operating personnel must not remove instrument covers. Component replacement and internal adjustments must be made only by qualified personnel.

Instruments that appear damaged or defective should be made inoperative and secured against unintended operation until they can be repaired by qualified service personnel.

Opening the instrument will result in loss of all warranty given for the instrument and may exhibit lethal health risks.

Keep away from live circuits inside the equipment. Operating personnel must not remove equipment covers. Only factory authorized service personnel or other qualified service personnel may remove equipment covers for internal subassembly or component replacement or any internal adjustment. Do not install substitute parts or perform any unauthorized modification of the equipment or the warranty may be voided.

### 1.9.10 VENTILATION

Keep a space of 30 cm or more between the rear side of the device and any other objects such as walls to guarantee sufficient cooling of the device.

Never block the air fan and ventilation openings.

### 1.9.11 CLEANING THE INSTRUMENT

To avoid personal injury, power down the device and disconnect it from line voltage before performing any of the following procedures.

To clean the exterior surface, perform the following steps:

- Remove loose dust on the outside of the instrument with a lint-free cloth.
- Use a soft cloth dampened with water to clean the device. Use 75% isopropyl alcohol solution as a cleaner. Do not use any abrasive or chemical cleaning agents.
- Safety Symbols on Instruments

#### 1.9.11.1 WARNING OR CAUTION



If you see this symbol on the product, you must refer to the manuals for specific Warning or Caution information to avoid personal injury or damage to the product.

#### 1.9.11.2 ESD SAFETY WARNING



This sign indicates that the respective modules, boards or RF inputs and outputs are susceptible to damage by electro static discharge (ESD), and require proper protection procedures for storage and handling.

#### 1.9.11.3 OUTPUT OF LASER RADIATION WARNING



This sign does indicate a source of optical radiation that may emit close to the location this label is present. Follow according laser safety procedures as listed below and defined in general rules at all times.

#### 1.9.11.4 WEAR EYE PROTECTION

Wear eye protection if exposure to high-intensity rays or laser radiation exists according to Laser safety rules and best practices.

#### 1.9.11.5 DO NOT DIRECTLY VIEW OPTICAL LASER PORT OUTPUT

Under no circumstances should you use any optical instruments to view the optical laser port output directly.

#### 1.9.11.6 PRECAUTIONS WITH CONNECTORS

It is essential to ensure that all optical connectors are in good condition. Dirty connectors can lead to poor performance, while broken connectors can cause damage to other equipment!

Before an optical connector is used, check it visually by using an optical microscope as recommended by the manufacturer of the connector. If the connector needs to be cleaned, apply the cleaning procedure recommended by the manufacturer of the connector.

Make sure you are familiar with these issues to avoid damage to your device and possible violation of warranty.

#### **NOTE**

**Important!** Before connecting the inputs or outputs to any measurement equipment or device under test, make sure that a suitable attenuator, if necessary, is fitted.

## 2 COBRITE DX SERIES - UNIT OVERVIEW – OPERATING PRINCIPLE AND BLOCK DIAGRAM

### 2.1 INTERLOCK

Interlock is a safety feature to be used in cases of emergency. It is not intended to be used in regular operation. If Interlock is active when the front panel power switch is enabled (MX) or the jumper located at the rear panel is removed (DX, DX2), the laser cannot be controlled as electrical power is removed from all lasers.

Note that all lasers remain off after the interlock has been triggered and require to be switched on again using software control even after interlock was released (MX) or the jumper re-installed.

The Interlock LED will be on in case the interlock is active which means that all lasers are switched off (MX only).

### 2.2 BLOCK DIAGRAM COBRITE DX

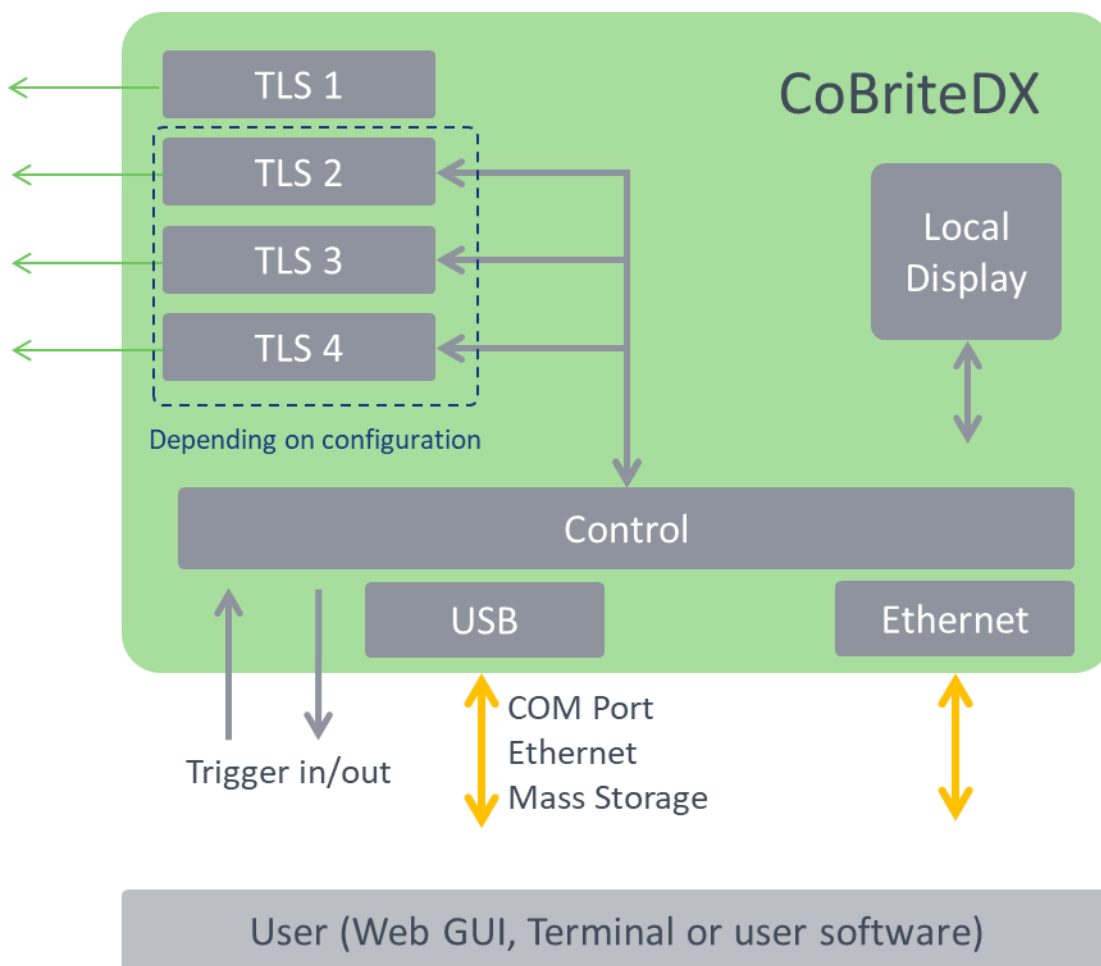



### 2.3 BLOCK DIAGRAM COBRITE DX2

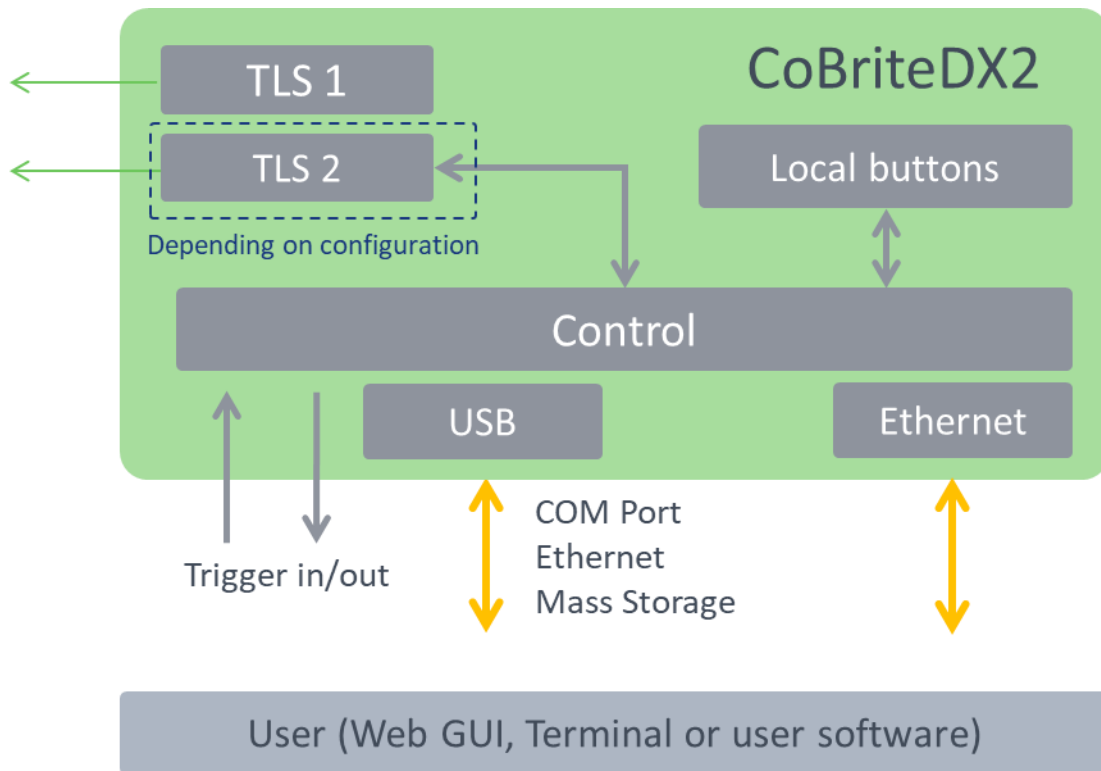

CoBrite is tunable laser instrument series capable of hosting up to 4 tunable laser ports that can be independently controlled. The series shares the same software and control architecture as well as the same portfolio of laser variants.

The CoBriteDX variant features a local touch panel display and supports up to 4 laser ports.

The more compact CoBrite DX2 supports up to 2 laser ports and is controlled remotely via the installation free browser-based GUI.

Different laser types are offered allowing users to adapt for various use cases such as coherent transmission, EDFA testing and insertion loss profile measurement.

User data transfer is provided via a SCPI interface utilizing USB and Ethernet interfaces. The unit supports multiple user connections and multiple user access right level administration. The user interface does not require any specific API Software or similar to be installed on host computers while providing a standardized communication protocol so that any user environment is able to communicate with unit.

The unit provides a built-in webserver that allows the control of the unit via any device such as PCs or smartphones that are able to run a Web Browser.

Using USB; the device provides a virtual Ethernet interface allowing to access the unit via browser or a telnet session. Additionally, a virtual COM port for straightforward serial access and a virtual Mass storage device (USB Stick) is installed providing access to the manual, programming examples and drivers.

The unit provides hardware triggers allowing triggering Laser setting executions as well as indication of laser tuning events.

### 2.4 COBRITE DX – FRONT SIDE OF UNIT

The front side is dominated by a large Touch Panel Color Display for intuitive control of the instrument. The optical connector plate type depends on the laser configuration equipped on the specific unit. The 2 screws allow to easily detach the front plate to allow removal and cleaning of the connector.

#### ! NOTE

The fibers attached to the plate are 250um buffered type and therefore sensitive to breakage under mechanical stress. So, take care if removing the connector plate to not damage optical fibers.

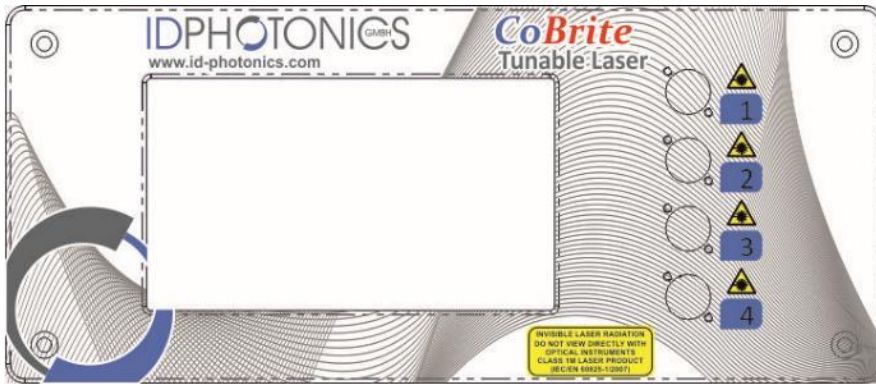

## 2.5 COBRITE DX – REAR SIDE OF UNIT

The rear side hosts electrical connectors that can be utilized by the user.

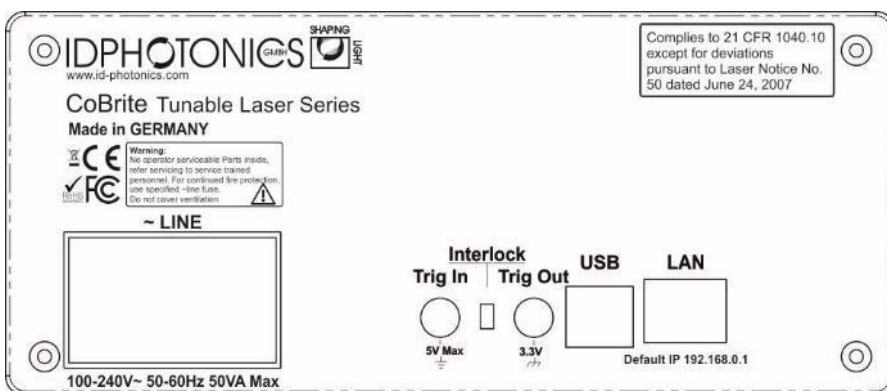

### ! NOTE

This unit contains a fan for forced air cooling. The inlet and outlet are slits located at the sides of the unit. Never block these areas to avoid overheating and failure of the unit.

### 2.5.1 POWER SOCKET

Electrical power is supplied using a VDE 0625, EN 60 320, C13 type electrical connector. Only use the supplied cable or an identical cable that conforms to the aforementioned standard to connect to the unit. The unit automatically adapts to local power line specifications within the range printed on the unit.

## 2.6 COBRITE DX2 – TOP SIDE OF UNIT

### ! NOTE

This unit utilizes the top cover for heat dissipation of internal components. Do not reduce the thermal dissipation by blocking the airflow in this area by placing items on it to avoid overheating of the unit.

## 2.7 COBRITE DX2 – FRONT SIDE OF UNIT

The optical connector plate type depends on the laser configuration equipped on the specific unit. The 2 screws of some versions allow to easily detach the front plate to allow removal and cleaning of the connector.

### ! NOTE

The fibers attached to the plate are 250um buffered type and therefore sensitive to breakage under mechanical stress. So, take care if removing the connector plate to not damage optical fibers.

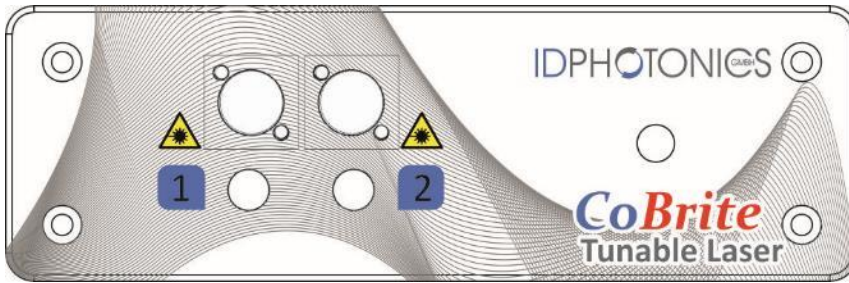

## 2.8 CBDX2 – REAR SIDE OF UNIT

The rear side hosts electrical connectors that can be utilized by the user.

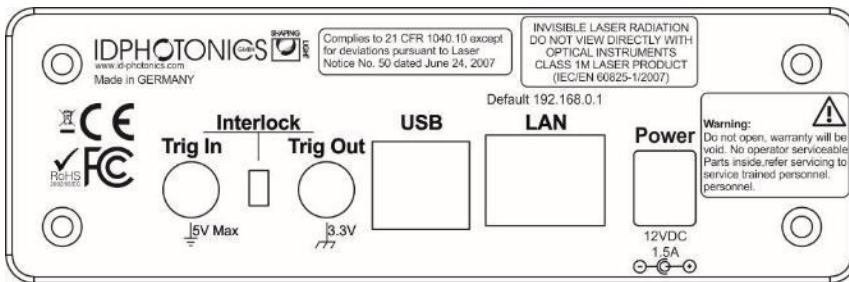

### 2.8.1 POWER SOCKET

Electrical power is supplied using a coaxial 12V DC jacket. Only use the supplied external AC/DC adaptor to power the unit. The AC/DC adapter unit automatically adapts to local power line specifications within the range and complies to standards printed on the adaptor.

## 2.9 COBRITE DX & DX2 SERIES - COMMON PORTS

### 2.9.1 TRIGGER PORTS

The SMA type sockets can be used to achieve timewise synchronization of the CoBrite with other equipment. Both ports support 3.3V LV TTL standardized signals.

**Trigger IN** allows triggering tunable laser setting if the feature is enabled via Remote control or GUI. Polarity and user set delays can be also configured this way. For positive polarity, the scan is started with the positive flank and will be fully executed regardless of the trigger in status afterwards. For negative polarity, the scan is triggered by the negative flank on the unit.

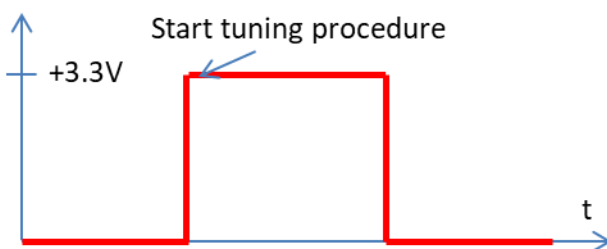

Each laser port installed on the chassis can be en- or disabled to be considered for the H/W trigger input using the command “TRINACT”. All considered ports are will only start to tune if a new setting has been set via software once the trigger in port has been initiated.

### ! NOTE

Per default, “trigger tuning” for all Lasers are disabled. Use SCPI commands to alter configuration.

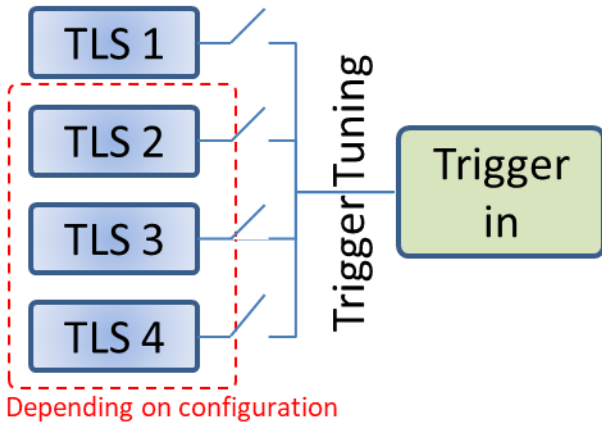

**Trigger OUT** provides an output signal indicating periods at which the one or more laser ports are tuning. The polarity of the signal and the logic of the signal can be changed via Remote control or GUI.

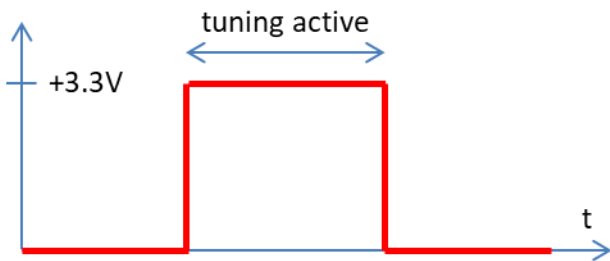

Each laser port installed on the chassis can be en- or disabled to be considered for the H/W trigger output using the command “TROUTACT”. All considered ports are combined via a logical “OR” for the tuning active true state.

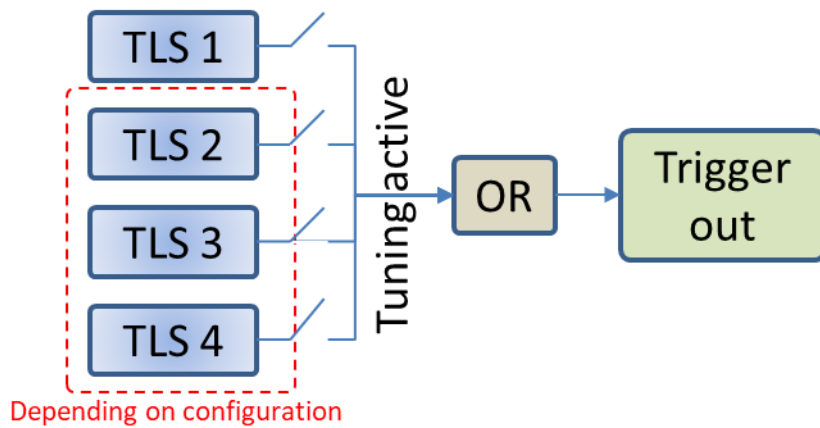

**! NOTE**

Per default, “tuning active” signals of all Lasers are considered for the joint trigger out.

**2.9.2 INTERLOCK**

Interlock jumper, installed by default. For details, see 2.1.

**2.9.3 DATA PORTS**

**Ethernet** – The RJ45 jacket is used to connect the unit to Ethernet networks based on the IEEE 802.3 standard. Per factory default, the unit is set to a fixed IP Address 192.168.0.1. The IP address configuration can be changed via Remote control or GUI. We recommend to initially connecting via USB to set up the Ethernet interface first. See section 0 for details on how to establish an application layer connection to remote control the unit.

**USB IN** – The USB 2.0 type B jacket is used to connect the unit a host computer to be able to operate the supplied GUI or perform remote control on the unit. See section 0 for details on how to establish an application layer connection to remote control the unit.

**USB OUT** – The USB 2.0 type A jacket is intended for future use and serves no functionality at this point.

## **2.10 OPTIONAL ACCESSORIES**

### **2.10.1 SINGLE 19" RACKMOUNT ADAPTOR CBDX-19-1**

This adaptor is used to mount one CoBrite DX chassis in a standardized 19" Rack in 2 HE slots.

### **2.10.2 SINGLE 19" RACKMOUNT ADAPTOR CBDX2-19-1**

This adaptor is used to mount one CoBrite DX2 chassis in a standardized 19" Rack in 1 HE slots.

### **2.10.3 SINGLE 19" RACKMOUNT ADAPTOR CBDX-19-2**

This adaptor is used to mount two CoBrite DX chassis in a standardized 19" Rack in 2 HE slots.

### **2.10.4 SINGLE 19" RACKMOUNT ADAPTOR CBDX2-19-2**

This adaptor is used to mount two CoBrite DX2 chassis in a standardized 19" Rack in 1 HE slots.

For mounting instructions, see the separate guide which is supplied in case you have ordered these accessories.

## 3 COBRITE MX SERIES - UNIT OVERVIEW – OPERATING PRINCIPLE AND BLOCK DIAGRAM

The CoBrite MX series consists of a series of mainframes host the tunable laser modules. Each laser module can host different laser types that can be mixed within a single chassis. Refer to the data sheet for details of the available laser types.

Cards can be added by the user at any time when the card power is off. Do never insert cards while the power is on.

### NOTE

**Always** cover unused slots with slot cover plates to ensure optimized airflow to the operating laser cards to prevent overheating of laser cards.

### NOTE

All Mainframes require **air flow** to enter the housing at its **bottom** to ensure proper circulation inside the chassis. **Never** cover those inlets to prevent overheating.

#### 3.1.1 POWER ON/OFF SWITCHES

Each mainframe features a central Power on/off switch located at the rear panel that will switch on and off all components of the chassis.

If the switch is in “on” position, the chassis controller and fan will start to operate. It will run at an elevated until the chassis controller has booted and actively regulates the fan.

The front panel power switch will enable power to all laser cards and be indicated by a green LED inset into the power button.

#### 3.1.2 STATUS LEDs

LED	DESCRIPTION
Interlock	Indicates the status of the interlock key switch. On: Interlock active – Lasers are switched off
Power LED	Will indicate that laser cards are powered on.
Activity / Ident	This LED is active if there is communication activity flow via remote interface. If the identification feature is activated in the GUI, this LED will flash.
Interlock	Indicates the status of the interlock key switch. On: Interlock active – Lasers are switched off
Alarm	This LED indicates active alarms. Use the Web or the SCPI Interface to retrieve further details

#### 3.1.3 COMMUNICATION PORTS

The units feature a USB type port and an Ethernet Interface located on the front of the chassis controller. A second Ethernet port can be found at the rear side of the Chassis.

##### 3.1.3.1 LEGACY CHASSIS

If the controller is located in a legacy chassis, there are 1 USB and 1 Ethernet port located at the back of the unit. In this case, these interfaces are operated solely as virtual serial interface (USB) and telnet (Ethernet). We

recommend to not use these due to the limited functionality compared to the full featured interfaces located at the front.

### 3.2 MX SERIES MAINFRAME OVERVIEW

All Mainframes host a user defined number of laser cards that are centrally controlled by a chassis controller via a backplane that provides access to users via USB and Ethernet. This controller provides thermal management via an actively controller fan located in the mainframe. The chassis variants depend on the number of slots provided to host laser cards.

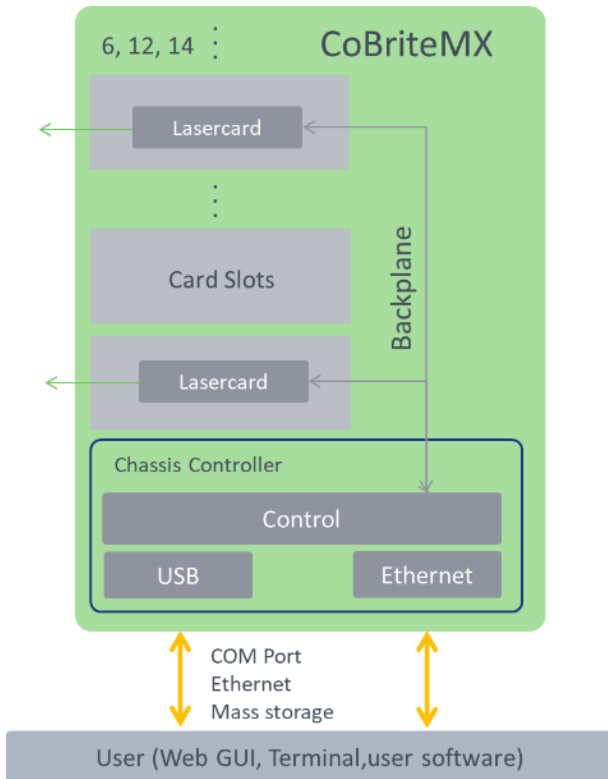

#### 3.2.1 CBMA24



This mainframe is designed for low to medium channel counts and hosts up to 6 cards that allows to for up to 24 lasers in a compact chassis.

#### 3.2.2 CBMA48



Is the core mainframe for demanding applications as it hosts up to 12 cards with 48 lasers. The CBMA48SL provides an extension interface to the CBSL56 extension chassis for solutions requiring more than 48 laser ports.



### 3.3 CHASSIS CONTROLLER

The chassis controller centrally controls all installed laser cards and gives users access to the system.

#### ! NOTE

The controller card shall not be removed from the chassis as it is not swappable.

#### 3.3.1 DESCRIPTION OF LED FUNCTIONS

If the Power switch at the back of the unit is switched on, the Power LED will indicate if electrical power is present.

##### 3.3.1.1 USB1 LED

will indicate communication activity using the USB Port located at the front panel of the device. It will light up if data is transmitted in either direction and remain for 10seconds after last activity.

##### 3.3.1.1.1 USB2&ETHERNET LEDS

provide the same functionality as described above for USB1 LED. USB2 & Ethernet ports are located at the backside of the chassis.

##### 3.3.1.1.2 INTERLOCK LED

will indicate status of the Interlock key switch. If Interlock is active, lasers will be switched off and this LED will be on.

#### 3.3.2 INTERLOCK KEY

Interlock key switch operated by a key supplied with the accessory kit in the blue map. For details, see 2.1.

#### 3.3.3 POWER SWITCH

The red power LED of the chassis controller will indicate whether electrical power is connected to the chassis. To switch on the unit including laser cards, press the round power button. A green LED indicates that the system is now in operation.

#### ! NOTE

There is a power switch at the back of the unit that needs to be switched on before any operation can be taken.

### 3.4 LASER CARDS

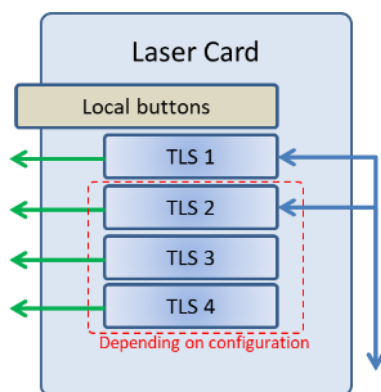

Laser cards are inserted into any free slot of the chassis and can contain different number and type of laser ports.

#### 3.4.1 LASER PORT LED/SWITCH

Each Laser port features a red status LED that indicates the status of the optical output. Some Laser card models allow enabling or disabling the optical output by using a button next to the optical output.

#### ! NOTE

Each LED acts also as a button which may be pressed to switch on and off the according laser port locally.



### 3.4.2 INSTALLATION OF A NEW LASER CARD

- Disconnect AC Power cord from unit
- Remove slot cover plate of an unused slot by unscrewing the 2 screws located at the top and bottom of the plate
- Insert the new laser card. Press the grey inset of the black lever at the face plate. This will allow tilting down the lever so that the card can slide in completely. Let the lever snap in and make sure the grey inset flips into its original position to lock the card.
- Lock the new card by using one screw located at the top of the face plate and inside the black lever.

#### NOTE

There are 2 screws to lock a laser card: One at the top of the face plate and one inside the black lever.

### 3.4.3 REMOVING A LASER CARD

Follow the instructions of section 3.1.2 in reverse order except for first step.

#### NOTE

Make sure to re-install a face plate cover once a laser card is removed to ensure air flow for proper cooling of remaining lasers.

### 3.4.4 PORT ENABLING/DISABLING

Laser cards are equipped with an LED indicator for each laser port that signals the operational status (Laser port on or off). At the same time, this indicator hosts a button that enables or disables each laser port by pressing it.

## 4 QUICK START – REMOTE CONTROL

This section contains redundant information from other chapters but is useful for a first-time usage of the instrument.

1. Power up the unit using the main power switch located at the back of the unit or plug in the AC power supply (DX2).
2. Wait until the boot sequence is completed:  
**DX2** device: The laser Port LED(s) will flash once  
**MX** device: The ready LED will light up  
**DX** device: The “Scanning for Devices” popup will disappear

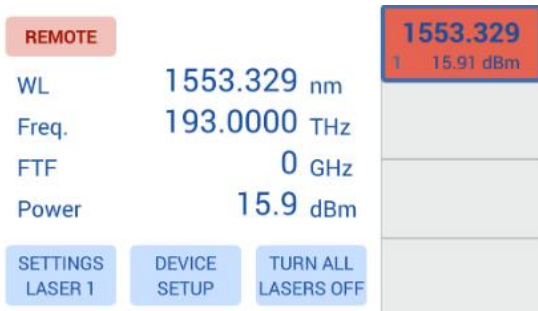

3. Connect the USB Port located at the rear of the unit to your Windows10 PC or connect the Ethernet Port to your LAN.
  - a) **For USB** based access, all drivers will be installed automatically, Windows device manager should show now 3 devices:
    - i) 1. A storage device containing manual etc.
    - ii) 2. A virtual Ethernet Interface “RNDIS”
    - iii) 3. A virtual COM Port

Both virtual COM and Ethernet Ports can be used to remote control the unit. The installed COM Port number can be retrieved from Windows device manager.

To access the WebGUI, the USB virtual Ethernet IP address is needed. If the DNS configuration of your computer allows, the IP address can also be retrieved by entering the command shell “ping cobrite.local” or retrieve it from the label located on back of the unit. For a DX chassis, it can also be retrieved via the Touch panel under “Device Setup”.
  - b) **For Ethernet** based access, the default IP of the unit is 192.168.0.1. Make sure that the host PC IP is in the same subnet as the laser unit (192.168.0.x). If this is not the case, you can change the IP settings of the unit via the touch screen or using the USB Port of the unit. Use <http://cobrite.local/> as an alternative to the IP address to connect to the unit if your DNS configuration of the network allows this access.
4. Open your Web browser, enter <http://cobrite.local/> or the IP address in the address field of the browser and hit <enter>. The Webpage allowing to control the laser remotely should open now.

### ! NOTE

Depending on the configuration of your host PC DNS structure, the <http://cobrite.local/> name representation might not be resolved into the correct IP address. In such a case, for a DX unit, retrieve the IP Address on the local touch panel under “Device Config – Network Config” and use it instead of the name. For a DX2 unit, open a connection to the USB virtual serial interface and type the command “USBIPADDR?;” to retrieve the USB IP Address or “IPADDR?;” for the IP address of the Ethernet interface or retrieve the IP address from the type label located on the unit. Note that not all units have this information printed on.

## 5 GETTING STARTED – ALL UNITS

This section contains more in-depth information on how to setup the remote interfaces on a host PC and basic principles of the laser.

### 5.1 CONNECTION OF HARDWARE

- Connect optical fibers to the laser output ports or make sure that no laser radiation can be uncontrollably be emitted by the unit.
- Connect the power supply of the unit using the supplied Power Cord and switch on the unit using the switch located at the back of the unit (DX only).
- Wait for the unit to finish initializing. For DX, the procedure is completed when the startup screen showing the ID Photonics logo is cleared and the laser parameters are shown. For DX2, the procedure is completed when the Laser Port status LEDs flash once. Now proceed with Software installation as described below.

### 5.2 ETHERNET CONNECTION

This section covers connectivity using Ethernet, skip this section if you plan on using USB.

The default IP address is 192.168.0.1, DHCP off. If you plan to connect using the Ethernet interface, make sure the host PC is within the same subnet as the CoBrite Ethernet Interface (The PC IP Address is 192.168.0.x then). The connectivity can be tested by opening a command shell (type “cmd” in windows search field and hit <enter>, a “black window with a DOS shell should open) and executing the command “ping 192.168.0.1”.

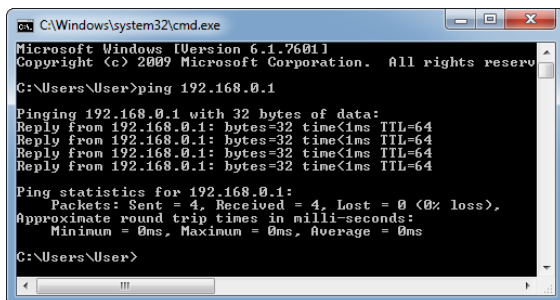

```

C:\Windows\system32\cmd.exe
Microsoft Windows [Version 6.1.7601]
Copyright (c) 2009 Microsoft Corporation. All rights reserved.

C:\Users\User>ping 192.168.0.1

Pinging 192.168.0.1 with 32 bytes of data:
Reply from 192.168.0.1: bytes=32 time<1ms TTL=64
Reply from 192.168.0.1: bytes=32 time<1ms TTL=64
Reply from 192.168.0.1: bytes=32 time<1ms TTL=64
Reply from 192.168.0.1: bytes=32 time<1ms TTL=64

Ping statistics for 192.168.0.1:
    Packets: Sent = 4, Received = 4, Lost = 0 (0% loss),
    Approximate round trip times in milli-seconds:
        Minimum = 0ms, Maximum = 0ms, Average = 0ms

C:\Users\User>

```

If you do wish to change the IP settings and do not have remote access to the unit follow either of the following sections depending on the type of chassis:

#### 5.2.1 COBRITE DX

Use the local touch panel and press “Device Setup”. Then press “Network setup” and configure the interface accordingly. Note that this change will require a reboot (soft reset of the unit) to become effective. Alternatively, use the WebGUI as described below.

#### 5.2.2 COBRITE DX2/DX

These units possess two IP Addresses. One for the physical Ethernet interface and one for the virtual Ethernet Interface generated by a USB connection. Only the one of the physical Ethernet interface settings can be changed and is handled in this section.

#### 5.2.3 COBRITE MX

The unit possesses three IP Addresses. Two for the physical Ethernet interface and one for the virtual Ethernet Interface generated by a USB connection. Only the ones of the physical Ethernet interface settings can be changed and is handled in this section.

**ALL:** If you do wish to change the IP settings of the unit via Web GUI, there are two cases:

### 5.2.3.1 HOST COMPUTER CAN CONNECT TO CURRENT IP ADDRESS OF COBRITE

Enter IP Address of unit in the browser address field of your host PC browser (default: 192.168.0.1). The CoBrite GUI should now open in the browser window. Go to connection tab, raise user level by entering password “IDP”, now change the IP settings and restart the unit to take the new setting into effect.

### 5.2.3.2 HOST COMPUTER IS UNABLE TO CONNECT TO COBRITE VIA CURRENT IP ADDRESS

Use this method if the “ping test” described above is not successful.

Connect the unit via USB and wait until driver installation is complete.

Retrieve the COM Port number of the virtual serial port using windows device. Open a terminal window to the virtual COM Port using i.e. PUTTY.

Send the command “pass IDP” to elevate the user level to 1 allowing changes to the IP configuration.

Use the command “ipaddr xxx.xxx.xxx.xxx” to set a new IP address of the physical Ethernet interface where xxx.xxx.xxx.xxx is the IP address you wish to use, ie. “192.168.5.12”. For more settings such as DHCP and netmask, see commands defined in section 8.7.

You can query the IP address setting via “ipaddr?”.

Reboot the unit using the command “\*rst” in order for the new IP configuration to become effective. The unit will immediately reboot after issuing this command.

### 5.2.4 OPENING A REMOTE CONNECTION VIA ETHERNET

The device supports a session based remote access on Port #2000.

Start the terminal program “putty.exe” supplied with the unit or use any other terminal program.

Set the following parameters in Putty and open the connection:

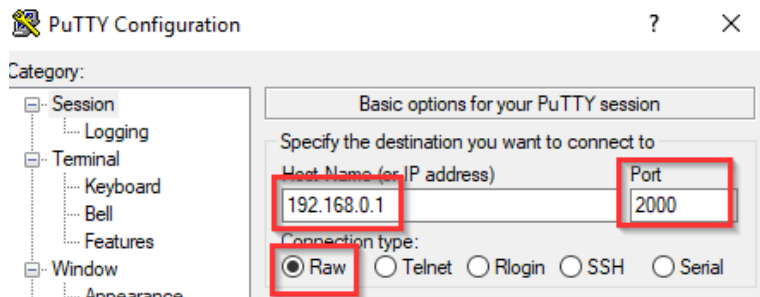

Alternatively, to the default IP Address shown above, enter http://cobrite.local/ or the IP address currently set to the unit. If in doubt, use the touch panel display “Device config” – “IP config” to retrieve the actual IP Address (DX only).

Note that there must be a valid route on the IP layer between the device and the host PC (i. e. the ethernet port of the host PC is set to the same subnet as the device, for example 192.168.0.2) must be established before continuing. Use a command shell and command “ping cobrite.local” to test the route.

Once the connection is established, type in “\*idn?” and hit <ENTER>. The unit responds with its \*idn? String.

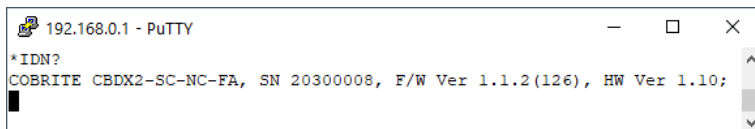

Alternatively, a request based remote control via http Port 80 is possible. To test this, open a browser window and type the following string into the address field:

http://cobrite.local/scpi/\*idn?

For more details, see section 8.2.

## 5.3 USB CONNECTION

This section covers connectivity using USB, skip it if you plan using Ethernet.

Once the unit is powered up and the USB cable is connected to the host computer for the first time, a new device installation should be triggered automatically within Windows.

Once installation is complete, three devices are installed on the host computer:

1. Virtual Ethernet Interface. The IP address of each unit is unique and fixed. Retrieve the IP address either by query “USBIPADDR?” or from the type label located on the unit. Note that not all units have this information printed on.
2. Virtual COM Port
3. Virtual Storage device that contains resources such as manual and programming devices as well as drivers for Windows 7.

### 5.3.1.1 WINDOWS 10 OR LATER

Windows 10 will automatically install 3 devices allowing to connect the unit

1. A virtual Ethernet interface (RNDIS)
2. A generic virtual COM port driver “Serial USB device”. If you have several COM ports installed in the host PC, you may want to note the COM Port number under which the unit got installed. For further details on USB connection, see section 5.3.1.3.
3. A storage device similar to an USB Stick containing resources for the laser unit

The virtual COM Port and the virtual Ethernet interface are concurrent ways to access the unit for remote control. The web-based control is automatically accessed via entering <http://cobrite.local/> into your browser.

### 5.3.1.2 WINDOWS 7

Windows 7 will install the same structure as described in the windows 10 section above. It will automatically install a virtual Ethernet interface (RNDIS) and the USB storage device (“Linux File- Store Gadget USB Device”). However, it does not have a preconfigured driver setup for the virtual COM Port. It will try to locate a driver for the unit on the host PC first and then check online. Stop the search and select the option “Install a custom driver”. Point the installation routine to the driver located on the USB storage device provided by the unit in directory “USBDriverWin7” and select file “CoBriteUSBSerialDriverWindows7.inf” in this folder. If the installation has been completed already, open Windows Device Manager, locate “CDC Serial”, right click on it and select “Update driver”. Proceed as described before.

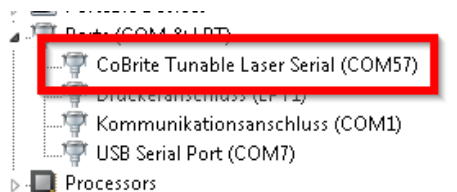
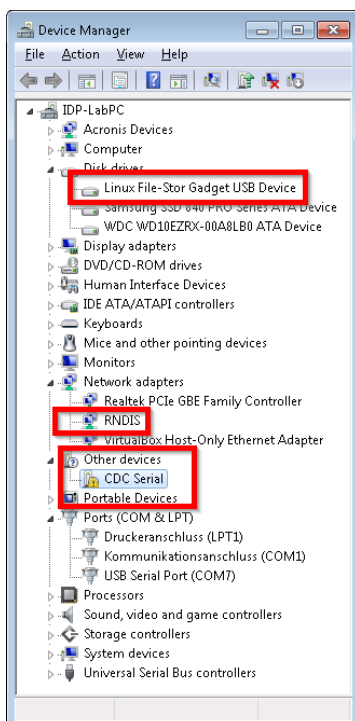

Continue with the installation routine. Once installed, the virtual serial/COM port should appear in Windows Device Manager as shown below. The serial/COM Port number will be different for your system. Note down the number for later usage in remote control applications.

### 5.3.1.3 CONNECTION TO THE DEVICE VIA USB VIA HOST PC

Once installed properly, the USB connection provides a virtual serial/COM Port and a virtual Ethernet Port to the instrument. To access the unit via virtual Ethernet, follow the instructions as in section 5.2 but note that the IP Address of the unit will be different as for the physical Ethernet Port and cannot be changed as it is assigned by the Windows host PC upon installation.

To access to the unit using the virtual COM port, open a terminal window using the installed COM port number per description above.

## 5.4 INSTALLATION OF CONTROL SOFTWARE

This instrument does not require any installation of software for operation. Once connected to a host PC or a local network, simply enter <http://cobrite.local/> into the address field of your Web browser to access the unit.

## 5.5 WHAT IF “COBRITE.LOCAL” CANNOT BE REACHED BY HOST COMPUTER?

Depending on the configuration of your host PC DNS structure, the <http://cobrite.local/> address might not be resolved into the correct IP address of the device.

### 5.5.1 COBRITE DX

Retrieve the IP Address in local Touch display under “Device Config – Network Config” and use it instead of the name or use the following method described for DX2 units.

Note that there are 2 IP addresses shown, one for the physical Ethernet interface (Network Interface) and one for the virtual Ethernet interface installed via USB.

### 5.5.2 COBRITE DX2

Connect via the USB Port using a terminal program, for details see 5.3. Open a connection to the virtual serial interface and type the command “USBIPADDR?;” to retrieve the IP Address for USB connection and “IPADDR?;” for physical Ethernet.

### 5.5.3 COBRITE MX

Connect via the USB Port using a terminal program, for details see 5.3. Open a connection to the virtual serial interface and type the command “USBIPADDR?;” to retrieve the IP Address for USB connection and “IPADDR1?;” for physical Ethernet located at the front panel and “IPADDR2?;” for the one located at the rear panel (non-legacy chassis).

### 5.5.4 ALL

After retrieving the address, enter the corresponding IP address into your browser address field to access the unit.

### 5.5.5 ALL, ETHERNET METHOD

If the default IP address of the device was not altered, it is “192.168.0.1”. Configure the Ethernet address of the host PC to 192.168.0.2. Make sure to disable to disconnect other Ethernet interfaces on this PC to avoid potential interference. Connect the Ethernet cable to the host PC and the unit. LEDs next to the Ethernet should become green. Enter “192.168.0.1” into your Browser on the Host PC.

### 5.5.6 ALL, LABEL

There is a label showing the serial number and part number located at the back of the unit (MX, DX) or at the bottom of the unit (DX2) that has the default IP Address for both Ethernet IP and USB IP.

## 5.6 LASER MODES

Coarse tuning allows accessing the full specified tuning range while fine tuning (FTF) allows for offsetting from the coarse tuning set point by a small range. The resulting set point is the sum of coarse tuning set point and FTF/fine tuning value.

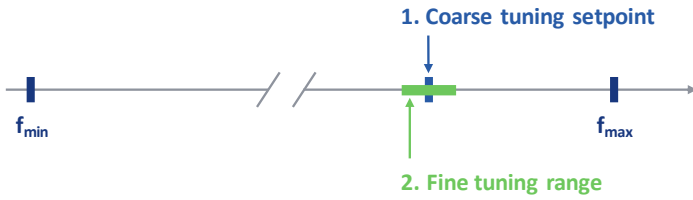

### 5.6.1 COARSE TUNING

This tuning mode allows tuning the laser to any frequency of the available range specified for the laser port. The tuning process will require the output to be disabled for a short period of time.

Description of tuning process:

1. Output will be switched off (~1 second)
2. Output is switched on using new frequency
3. Power is increased until final output power is reached. Maximum tuning times for this step differ from laser type to laser type.
4. Power is stabilized, tuning process is completed.

Note that the time to tune the laser is the actual time required to tune the laser, the software based tuning indicator may indicate a tuning state for a longer time period than the actual tuning requires.

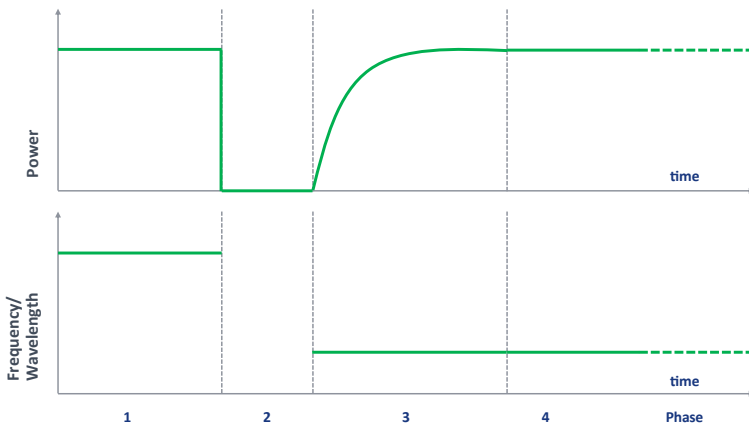

### 5.6.2 FINE TUNING (FTF)

Fine tuning allows detuning the laser within a small range from the target frequency set using the coarse tuning parameter. The laser will detune to the target setting with output power on during the tuning process which changes the output frequency in a linear ramp.

1. Tuning is triggered
2. Tuning process taking ~1second per GHz. Power remains constant – Power remains constant
3. Laser settles on new value

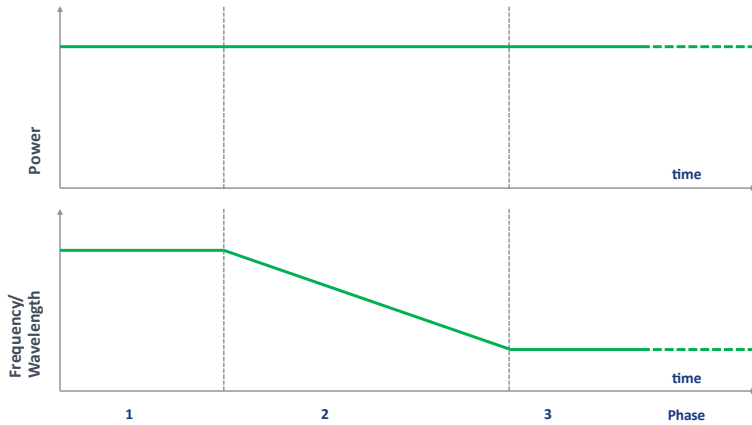



## 6 DESCRIPTION OF FRONT PANEL OPERATION – COBRITE DX ONLY

After the device has initialized, the front panel will look as depicted below:

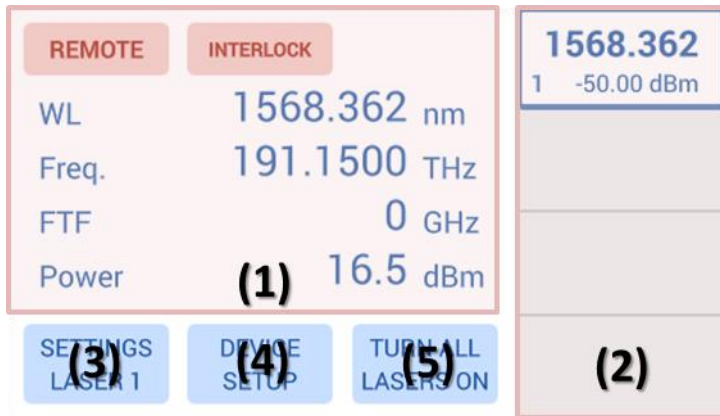

1. The central main field displays key parameters defining the current optical status of a laser selected by the right-hand tab. Touch on any of the parameters to change them.
2. The right-hand side tabs display the laser ports installed in the unit indicating on/off/tuning status by the background color, current wavelength/frequency and optical output Power. Touch a tab briefly to select the laser to display details in the central main field. If the tab is pressed for a longer time, an increasing red progress bar will be displayed. If at 100%, the laser will be toggled on if previously off or vice versa. A flashing background indicates that the laser is currently tuning.
3. Pressing “Settings Laser x” will open a pop up allowing to change parameters of the selected laser.
4. “Device Setup” allows changes to the chassis set up such as IP configuration, base unit wavelength/frequency etc. See below for details.
5. “Switch on/off all lasers” will simultaneously en- or disable the laser output power.

The red “Remote” indicator will only be displayed if one or more remote connections are active.

“Interlock” will only be displayed if the hardware laser safety jumper located at the rear of the unit has been removed. In this state, all lasers are disabled and can only be switched on again if the jumper is installed again.

“Error” will only be displayed in case of active errors present.

The screenshot to the right is taken in a regular operational state with 4 Laser outputs switched on. Laser 1 is selected

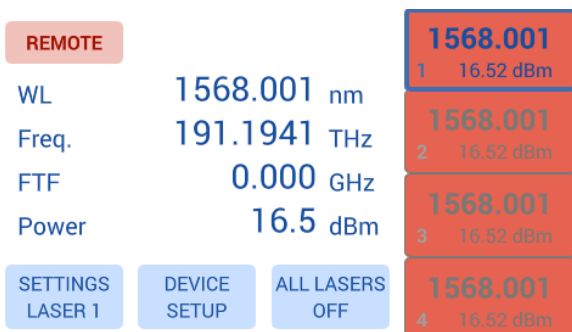

To enable or disable the laser output, touch the laser selection button for about 1 second. If the laser status is off, the field will start to fill red. Once the field is filled, the laser will be switched on and vice versa for switching the laser off. The same method applies to the “All Lasers On/Off” button.

A flashing laser selection button indicates that the laser is currently tuning.

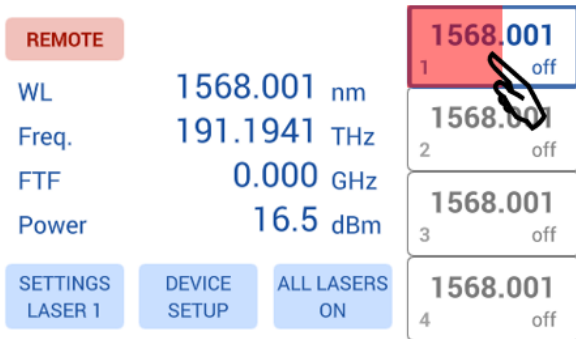

### 6.1 SETTINGS LASER BUTTON

Touching “Settings laser x” button or the central current status field will open a popup allowing to set the laser parameters.

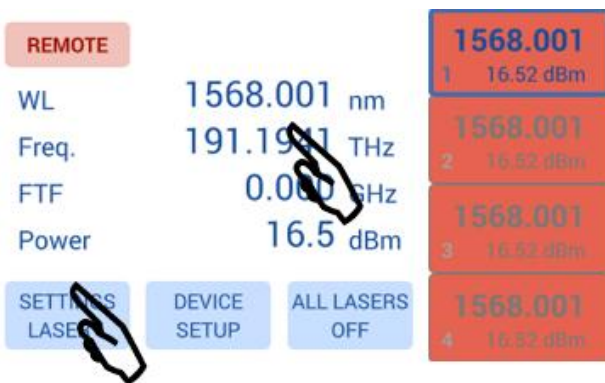

Select the parameter to be changed by touching on the corresponding button. The current parameter setting is displayed in the field below. Change the setting by swiping the corresponding roll bar to change each digit or use the horizontal slider for coarse tuning. If a value exceeding the limits of the laser is dialed in, the limits will be shown and the ok button will be disabled. Move the setting back to a valid setting or cancel the popup.

Once the new setting is dialed in, proceed to the next parameter or press “ok” or switch to the next laser port to be set by pressing the Laser “x” button located on the upper left side. The laser will be subsequently tuned to the new setting. The tuning process is indicated by a flashing of the port overview located at the right-hand side. The base unit for the laser Wavelength/Frequency can be changed in the “Device Setup” popup.



In Frequency mode, a touch button “Grid” is displayed that allows applying a virtual Grid to the Frequency roll bar. With this, the minimum increment of the laser frequency equals the grid value set. Note that this feature will not alter the settings of the laser port itself but eases the setting touch panel of the laser. A concurrent remote session will still be able to set the laser to any frequency it supports.

### 6.2 DEVICE SETUP

Touching “Device Setup” button located in the main screen will open a popup allowing to set device parameters.

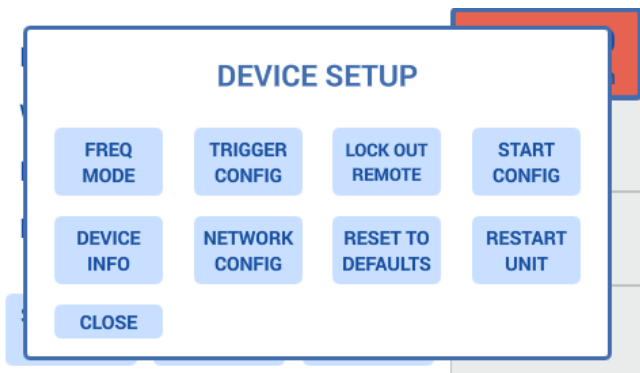

### 6.2.1 “WAVEL. MODE” / “FREQ MODE”

toggles the base unit for setting the laser between wavelength and Frequency in the Laser setting Popup as well as the Laser selection button located right hand side on the main screen.

### 6.2.2 “TRIGGER CONFIG”

Defines the trigger action configuration. Press the corresponding buttons to toggle the setting. See section 2.9 details on trigger configuration.

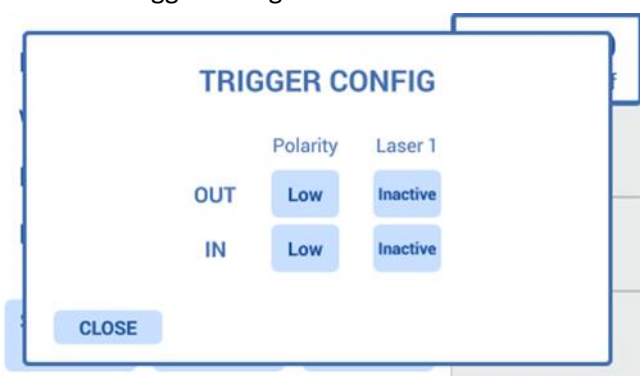

### 6.2.3 “LOCK OUT REMOTE”

will block remote commands that alter the configuration of the unit to prevent interfering commands coming in by these remote connections. A popup up to confirm the change of the setting will be shown as potentially active remote connections will no longer be able to issue commands. A remote connection is any access established to the unit via USB or Ethernet and applies both to the Web-GUI and any user program.

### 6.2.4 “START CONFIG”

Allows configuring the Startup behavior of the unit. “Start configuration” allows two settings:

“**Factory defaults**” starts the laser ports with predefined settings defined by ID Photonics.

“**Last Configuration**” will save the settings each time it is changed by the user and set these upon restart of the unit.

“**Laser Autostart**” will allow to also set the last laser output on/off setting upon restart of the unit.

**CAUTION: If enabled, the lasers may automatically switch on upon restart of the unit.**

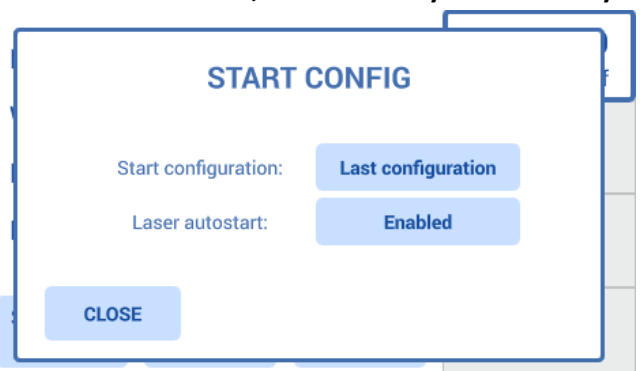

### 6.2.5 “DEVICE INFO”

Provides Information such as Software revision, serial number and device configuration.



### 6.2.6 “NETWORK CONFIG”

Displays the Network Configuration of the physical Ethernet Interface as well as the virtual Ethernet Interface available on the USB Port allows setting the parameters by clicking on the corresponding parameter button.

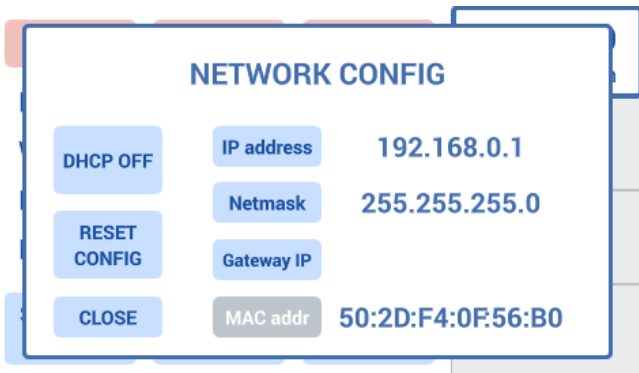

Popup to set the IP address:

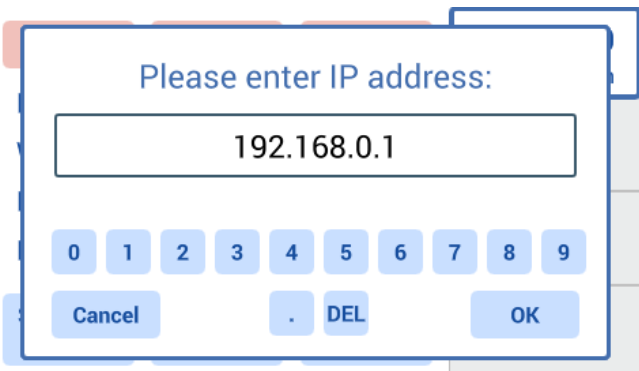

Note that changes to the Network settings will only take effect upon restart of the unit. Therefore, after a change of settings, a popup will appear allowing to restart the unit.

### 6.2.7 “RESET TO DEFAULTS”

This will reset all settings stored by the user back to the factory defaults except any remote interface setting. A popup containing a warning will be displayed and needs to be confirmed before the settings are deleted.

### 6.2.8 “RESTART UNIT”

Will perform a reboot of the unit. This action is identical to the SCPI remote control command “\*rst”.

### 6.3 DESCRIPTION OF FRONT PANEL OPERATION COBRITE DX2 & COBRITE MX SYSTEM

The DX2 & MX chassis allows to en- or disable the output of the corresponding laser port by pressing the red button located next to each port. Note that this requires the unit to have started up which takes about 20seconds after power on and the interlock jumper located at the rear of the instrument to be disabled (jumper set, default). This button simultaneously acts as a port status indicator and can assume 3 different states:

- LED off indicates that the laser output is currently off
- LED on indicates that the laser output is currently on
- A flashing LED indicates that this laser port is currently tuning to a new setting

Use the remote-control panel to access any other setting of the laser.

## 7 DESCRIPTION OF INSTRUMENT OPERATION USING THE WEB GUI – ALL DEVICES

The laser chassis can be accessed by any device such as smartphones, PCs etc. that are able to operate a web browser. The Web Interface was tested on Windows 7 and Windows 10 Computers using Edge, Chrome and Firefox and iPhone/iPad using Safari browser. Note that we cannot guarantee operation in any Browser environment in general.



If connected via USB, a virtual Ethernet interface is installed on the host system so that the Web Interface based access is enabled. Note that the IP address of the USB Port is different from the IP address of the Ethernet interface.

To access the unit, enter `http://cobrite.local/` or the current IP address of the unit into the address field of your browser to open the GUI. The GUI was tested with Edge, Chrome and Firefox with current revisions at the time of testing.

For details, see 4.

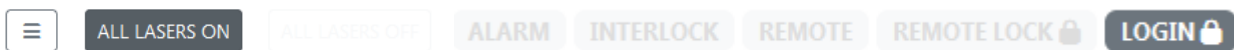
### 7.1 STATUS BAR



The  Button gives access to a pull-down menu that provides resources (Downloads, Remote Control and Help) as well as unit management to restart or shutdown the unit or update the firmware. The lock indicates that the user level must be raised to be able to perform use this function. Use the  button to elevate the user Level.

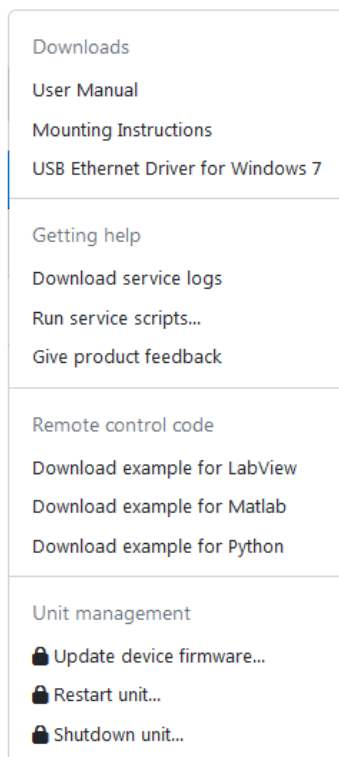

**“Download service logs”** will collect debug information of the system in case of issues. Allow up to 2 minutes to finish the collection, save the binary data to the host PC and send it to ID Photonics for troubleshooting. The files are not user viewable.

**“Run Service scripts”** allows executing scripts provided by ID Photonics for troubleshooting.

**“Give product feedback”** In case the host PC is connected to the internet, this will open a web form on the ID Photonics Website allowing to provide feedback about this product.

### 7.1.1 UPDATE DEVICE FIRMWARE

“Firmware Update” allows installing a new firmware into the unit. Please follow the following steps:

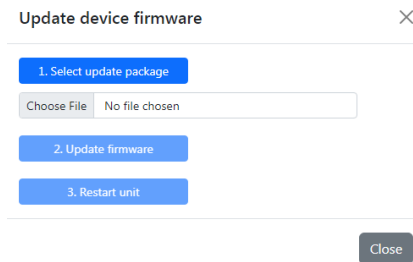

1. Connect via the Web Interface
2. Elevate the user level to at least 1 by entering the password in Login. The default password is “IDP”. Note that this may have been changed by a user before on the unit at hand.
3. Use the “Choose File” button” to locate the firmware file provided by ID Photonics. The new firmware is a single ZIP File. Do not extract this archive. Select the file and then press button “Update Firmware”. Do NOT close the browser window yet.
4. The file is first uploaded to the device, checked and installed. This takes less than 1 Minute to complete. Once the process is complete, a message will inform the user that the installation is complete.
5. Press “Restart unit” to perform a warm start of the unit to activate the new firmware.
6. After restart, make sure to press “reload” in your web browser window to empty the cache as some information may not be updated otherwise. The current installed firmware version can be checked in “Connection” Tab under “Device info” or in the local touch panel interface (DX chassis only) to determine if the upgrade was successful.

“**Restart unit**” will restart the connected unit after a popup confirms the reboot action.

“**Shutdown unit**” will close the operating system of the connected unit to avoid data loss before removing electrical power after a popup confirms the action. Laser will be switched off in this case. Toggle the electric power to restart the unit.

The “**All Lasers off/on**” button allows toggling laser on/off status of all laser ports at the same time.



The Files Dropdown menu allows opening resources such as the manual related to the unit. These resources are stored locally in the unit.

“**Alarm**” indicates pending or latched alarms. Click on the button to retrieve *alarm details* in case of a failure.

Alarms can be latched so that intermittent occurrences can be detected by the user. These alarms can be acknowledged and cleared by pressing “Clear latched alarms”

“**Interlock**” indicates the status of the interlock jumper located at the rear of the unit (DX2, DX) or via a physical lock located on the chassis controller front (MX). If the jumper is removed or the lock released, the indicator will light up red lasers are put into physical shutdown. Install the jumper or toggle the lock back to enable the lasers again. These will not return switch on again automatically.

“**Remote Lock**” indicates if another user has blocked remote access to the unit. If this status is set, other remote connections cannot alter settings of the device. See 8.7 for details.

“**Login**” allows elevating the user level to perform tasks requiring access rights. Any of these tasks are indicated by a  symbol. If the user level is raised, the button indicates the current user level . For details see 8.4.

### 7.2 “LASERS” TAB

The start page launches in Tab “Lasers” and contains a table of which each line is representing a laser port with the port coordinate scheme defined in the remote section of this manual.

Port	Laser Type	Wavelength [nm]	Frequency [THz]	FTF [GHz]	Set Power [dBm]	Actual Power [dBm]	Laser	Actions
1-1-1	GC	1568.772	191.1000	0.000	9.50	off	<input type="checkbox"/>	SETTINGS
1-1-2	GC	1568.773	191.1000	0.000	9.50	off	<input type="checkbox"/>	SETTINGS

Each line indicates the current setting of each laser port and the laser type present.

**Change one Parameter** – To change the setting, click on the corresponding parameter and enter a new value which will be set to the laser port after the “ok” button was clicked.

**Change several Parameters at once** – Click on the “Settings” button. A Popup opens in which parameters can be changed. Complete the change by clicking “save changes” or discard by clicking “close”. The advantage of this method is that all parameters are changed in one tuning cycle as opposed to several subsequent cycles if the parameters are entered one after the other as described before.

Click on the Laser on/off button if you wish to en- or disable a laser port using the current settings.

**Laser settings** ✕

Port  
1-1-1

Wavelength (1527.605 .. 1568.609 nm)  
1568.609

Frequency (191.1200 .. 196.2500 THz)  
191.1200

FTF (+/-10.00 GHz)  
0.00

Set Power (8.8 .. 17.8 dBm)  
8.8

Laser on/off status  
**LASER OFF**

*Note, laser out will be switched off during tuning if frequency parameter is changed.*

### 7.3 „TRIGGER“ TAB – COBRITE DX & DX ONLY

This tab shows the trigger action configuration. Press the corresponding buttons to toggle the setting. Changes require a user access level of 1 or higher. See section 2.9 details on trigger configuration.

Configuration	Polarity	Laser 1	Laser 2	Laser 3	Laser 4
Trigger Out	<input type="checkbox"/>	<input checked="" type="checkbox"/>	<input type="checkbox"/>	<input type="checkbox"/>	<input type="checkbox"/>
Trigger In	<input type="checkbox"/>	<input type="checkbox"/>	<input type="checkbox"/>	<input type="checkbox"/>	<input type="checkbox"/>

### 7.4 “CHASSIS VIEW” – COBRITE MX ONLY

This view presents a pictographic representation of the current chassis configuration. Each laser port is represented by its current Wavelength/Frequency Setting and power. Solid red indicates the laser output is on and tuned. Flashing red indicates that the laser port is currently tuning. Click on a laser port to open a popup allowing modifying settings. The small “i” indicator will open a tooltip containing further card level data such as serial number, firmware and hardware revision.



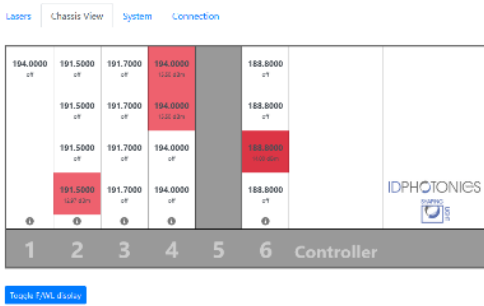

### 7.5 “SYSTEM” TAB

This tab gives an overview of the device configuration and status.

#### Start configuration

- Start with factory defaults
- Laser autostart disabled

#### Settings storage

- Save configuration to file
- Restore configuration from file
- Reset all user settings

“Start configuration” allows two settings:

“Start with *Factory defaults*” starts the laser ports with predefined settings defined by ID Photonics.

“Start with *Last Configuration*” will save the settings each time it is changed by the user and set these upon restart of the unit.

“*Laser Autostart*” will allow to also set the last laser output on/off setting upon restart of the unit. For laser safety reasons, this feature is not available on CoBrite MX systems.

#### ! NOTE

**CAUTION: If enabled, the lasers may automatically switch on upon restart of the unit.**

#### “Settings Storage”

“*Save Configuration to file*” will save the current settings of the lasers to a csv file on the host PC using SCPI commands defined in this manual. This can be used as a template to modify the settings. Example:

```
conf 1,1,1,191.1000,0.000,9.50,0,-1
conf 1,1,2,191.1000,0.000,9.50,0,-1
```

“*Restore Configuration from file*” allows restoring laser settings by loading a file previously stored by “*Save Configuration to file*” as described above. Additionally, it can be used to execute SCPI scripts from a file as defined in this manual.

“*Reset all user settings*” will restore the factory settings including all system settings such as IP Address configuration etc.

### 7.6 “CONNECTION” TAB

This Tab provides info on the device such as Part/Serial Number, Hardware and installed Firmware revision. It also allows changing the IP Configuration of the network interfaces of the device.

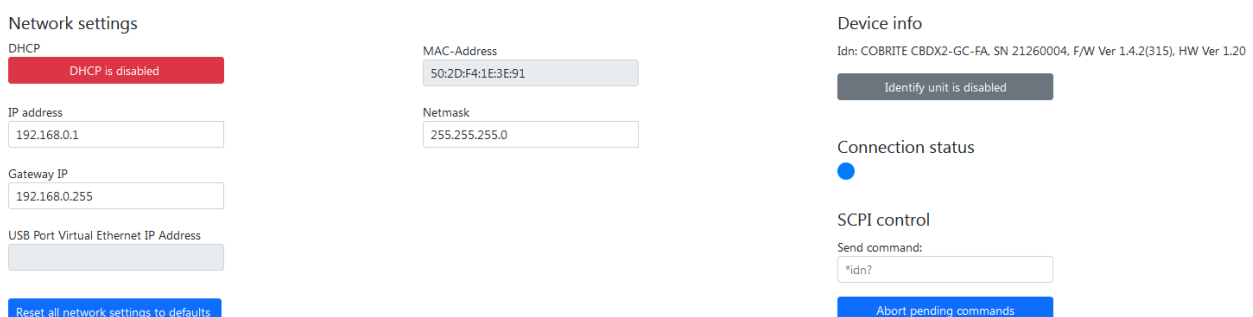

**“Network settings”** displays the current settings of Ethernet ports installed in the unit. The view may look different depending on the type of device being used. Elevate the user level by entering the password “IDP” to change the Network settings.

**“USB Port Virtual Ethernet IP Address”** shows the Virtual Ethernet IP Address of the unit. Note that this IP cannot be changed. For details, see 5.3.

**“Reset all network settings to default”** will set all network settings to factory default. The change will only become effective after a reboot.

**“MAC Address”** provides the MAC address of the physical Ethernet interface of the unit. This cannot be changed.

**“Device Info”** provides info such about the unit: Device P/N, Serial Number, Firmware Version, Hardware version.

**“Identify unit”** will open a blinking button in the local touch display or, in case of a DX2 unit, flash the laser port LEDs of the connected unit. It allows the identification of the unit currently controlled by this session in case several units are present on the network.

**“Connection status”** indicates active communication between the unit and the browser session. The blue dot will morph its size when communication is active.

The **“SCPI Control”** field allows executing commands defined in the remote section of this manual. The response will be displayed in a popup window. The user level for execution is the same as for the whole browser session. **“Abort pending command”** allows to stop pending commands in the command queue.

**“Abort pending commands”** erase the internal command queue and stop executing pending commands. Commands in execution may not be terminated immediately.

## 7.7 “LOGGING” TAB

Communication log

Log events:

SCPI commands  SCPI replies Clear log

This tab allows tracing of SCPI commands that are sent via remote interfaces for debugging or for generation of templates for scripts. This will also record user interactions in the Web GUI to allow recording the commands required to recreate the current state.

Check the boxes to select the parts of the communication you wish to monitor.

## 8 REMOTE CONTROL – ALL DEVICES

This device operates using SCPI standard style commands which are ASCII based and allow easy communication and interpretation with the instrument. Refer to chapter “Board and Connector description” on how to establish communication to the ports available at the instrument. More detailed information on SCPI syntax can be found here: <http://www.ivifoundation.org/docs/SCPI-99.PDF>

### 8.1 OPERATING MULTIPLE INTERFACE PORTS

This unit supports parallel usage of all remote-control ports available. Note that responses to commands issued are only returned to the according interface from where the command was issued.

Commands are generally executed in order of time wise arrival to the controller and buffered into an Event queue. If a stack overflow occurs, an error is issued.

Note that there is no control exclusivity for a specific interface or user. Thus, parallel commands issued by different instances will be might lead to inconsistencies. It is therefore recommended to poll current parameter status to ensure integrity of set vs. actual parameters and query the operation complete register (“\*opc?”) to make sure all previous commands have been executed or applied to the laser control. Note that it is recommend to use the query “busy?” to determine if a laser port is still tuning as the “\*opc?” query will only tell if the corresponding change of configuration has been triggered but might not be completed.

It is possible to lock out other remote sessions to avoid changes by using the remote lock command. For details, see section 8.7.

### 8.2 QUERY CONNECTION TYPES

Connections to remote control the unit via SCPI can be made either by using telnet protocol on port 2000 or HTTP queries. While for performance reasons, telnet-based access should be preferred, HTTP based access can be used in installations where Port 2000 is blocked by Network firewalls or routers since HTTP uses Port 80 which is open in most networks.

#### 8.2.1 TELNET BASED

Connections made with the device can be session based by a raw terminal connection (see 0) using Port 2000 for Ethernet or a COM Port session (5.3.1.3).

Connections through HTTP Service (Port 80). In this case, the SCPI command is encapsulated in the following http request:

```
http://<CoBrite IP>/scpi/<SCPI-Command>
```

#### 8.2.2 HTTP BASED

Example: `http://cobrite.local/scpi/*idn?` queries the identification string of the unit. For a quick test, simply copy this query into the browser address field.

The ASCII encoded response is identical to the session-based response.

<wsp> characters defined in the SCPI definitions are to be replaced with ASCII string “%20” per HTML code standard requirements. No termination character “;” or <CR> is needed for HTTP based access.

Multiple commands can be sent within a single query by means of separation via the termination character “;”

Example: `http://cobrite.local/scpi/*idn?;lay?`

Note that this connection type is not session based like the terminal connection. So, each query sent will establish a new session which is terminated after the query response is given. Consequently, commands requiring elevated user rights will require to send the password with the actual query in the same request.

Example: `http://cobrite.local/scpi/pass%20IDP;pass?`

will send the password “IDP” to the unit to elevate the user level.

### 8.3 SYNTAX CONVENTIONS FOR COMMANDS

#### 8.3.1 LONG AND SHORT FORM

The key words feature a long form and a short form. Either the short form or the long form can be entered in one command, other abbreviations are not permissible.

Example: “:SYStem:IPADDRess?” is equal to “IPADDR?”

#### NOTE

The short form is marked by upper-case letters; the long form corresponds to the full expression. Upper-case and lower-case notation only serve the above purpose, the instrument itself accept both upper-case and lowercase letters.

#### NOTE

All commands are case insensitive. Long and short form may not be mixed within a single command.

#### 8.3.2 QUERY COMMANDS

Most commands serve a double function that allows either setting or executing a query on a parameter.

#### NOTE

Query commands are terminated by a “?” character.

#### 8.3.3 PARAMETER

Parameters must be separated from the header by a “white space”. If several parameters are specified in a command they are separated by a comma “,”.

#### 8.3.4 COLON CHARACTER

A leading colon character “:” instructs the instrument to interpret the command starting at the root (highest level) of the command tree. Since the Instrument also starts at the root each time you send it a new command, the leading colon is not required (although the instrument will accept it if you send it).

#### 8.3.5 COMMAND TERMINATION CHARACTER FOR TELNET AND SERIAL COMMUNICATION

Each command must be terminated either by a “;” = 0x3B character or a line feed <LF> = 0x0A to signal completion of the command telegram to the controller. Depending on settings of the connection, the host buffer is only sent to the unit if a <LF> is used. Therefore, it is recommended using <LF> for sending commands. The response termination is always “; <LF>” = 0x3B0A. In this documentation, the <LF> is not shown to enhance readability.

#### NOTE

Sending two termination characters is a common mistake causing the unit to respond with “ERR 100; <LF>” since the first command is executed once the first termination character is received and the second termination character causes the unit to interpret an empty command.

Example:

Command: “wav 1550; <LF>”

Response “; <CR>ERR 100, unknown command; <LF>”

The unit will set wavelength 1550nm to port 1,1,1 but additionally receives the empty command which causes the error response.

### 8.3.6 ACKNOWLEDGEMENT OF EXECUTED COMMANDS

The mainframe controller will always acknowledge successful execution of commands by a “; <LF>” character. If the echo option is set (for details, see command list), the accordingly sent command is returned first.

### 8.3.7 LASER PORT ADDRESSING SCHEME

Laser ports are addressed by a three-level port identifier that allows easy identification of the port and are issued as parameters with according commands. Each level parameter is separated by a “,” character.

#### NOTE

If no laser port address is added to the command, Laser port 1,1,1 is addressed automatically, i. e. SOUR:WAV? queries the wavelength setting of laser port 1,1,1 and is equivalent to the command SOUR:WAV? 1, 1, 1.

IDENTIFIER	DESCRIPTION
<C>	Chassis identifier 1: Always 1 for CBDX chassis type 1: for CBMA48(SL) main chassis 2: CBSL56 slave chassis
<S>	Slot identifier. Range: 1 : Always 1 for CBDX chassis 1 – 6: CBMA24 6 slot chassis 1 – 12: CBMA48 12 slot chassis 1 – 14: CBSL56 14 slot slave chassis
<D>	Device identifier for Laser port on each card. Range depending on number of installed lasers in DX chassis or MX Card in case of MX chassis: 1,2,3,4 : DX2, DX, CBMX

Examples:

SOUR:WAV? 1,1,3; queries the current wavelength of Port 3 on card 1 in master chassis 1 or Port 3 of a CoBrite DX chassis.

SOUR:WAV? 1,4,2; queries the current wavelength of Port 1 on card 4 in slave chassis 2.

#### 8.3.7.1 WILD CARD CHARACTER

A special wild card character “\*” is used to address several ports at a time. This can be used for both set commands and query commands. Possible wildcard combinations are \*, \*, \* or x, y, \* but not x, \*, \*.

Example: SOUR:WAV 1, 2, \* 1555.1234; will set all Lasers of slot 2 in chassis 1 to 1555.1234nm.

#### NOTE

If a query is executed using a wildcard character, the parameter will be preceded a location identifier. Parameters returned for each port are separated by a „\n“ (=ASCII Code #10) for easier readability.

Example: SOUR:WAV? 1,2,\*;

Will query current wavelength of all lasers of slot 2 in chassis 1 and will return: 1, 2, 1, nnnn . nnnn\n

1, 2, 2, nnnn . nnnn\n

1, 2, 3, nnnn . nnnn\n

1, 2, 4, nnnn . nnnn; \n

### 8.3.8 COMMUNICATION EXAMPLE

Host sends: \*idn?;

unit response: IDP-COBRITE CBDX-NC-NN-NN-FA, SN 19160001, F/W Ver 1.0.0(101), HW Ver 1.00;

### 8.3.9 BASIC SCRIPT EXAMPLE

The following commands can be a minimal script to perform a basic set up of the unit and read the data

COMMAND	COMMENT
INTI;	Initialize Communication settings
*IDN?;	Query idn string of unit
PASS IDP	Raise user level to 1
DEFAULT;	Sets unit settings to factory default
WAV 1550;	Sets Laser 1-1-1 Wavelength to 1550nm
pow 14;	Sets output Power of laser 1-1-1 to 14 dBm
stat 1;	Enables Laser 1-1-1 output
*opc?;	Queries if command has been executed (status 1).
busy?;	Queries if the laser port has finished tuning and has settled on target settings that were set before
bwai *,*,*;	Unit will acknowledge once all laser ports have finished tuning.

Screenshot of script example result:

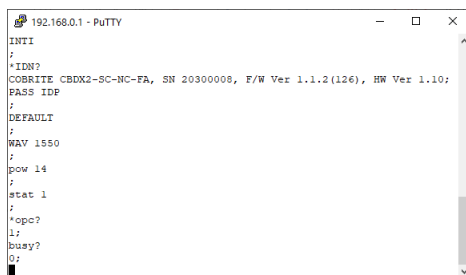

<ENTER> was used to execute the command. Alternatively, use “;”. If both is used, it is interpreted as 2 commands of which the second one is empty so that the first command is executed but the second produces an error since empty.

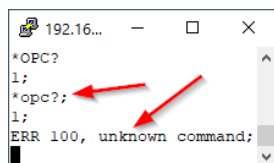

### 8.4 USER ACCESS LEVEL

This feature allows execution of commands protected in standard access level to avoid accidental change of important parameters. See command description “[ :SYStem: ] PASSwOrd” for details on how to enable enhanced access.

Custom passwords can be set to the unit for enhanced security requirements. See details in description for “[ :SYStem: ] SetPASS<wsp>, <P>, <P>”.

#### ! NOTE

User access level is granted session based. Each time, a new remote connection is made; the standard User access level 0 is set per default.

USER ACCESS LEVEL	PASSWORD
0	-
1	IDP

## 8.5 NOTATION OF SYNTAX FOR COMMAND DEFINITION

SYNTAX AND TYPE	DESCRIPTION
[ ]	Optional command level that can be omitted. Example: Definition [ :SYStem:] IPADDRess/? /<P> Allows sending the command: IDADDR?
< >	Denotes a parameter. Placeholder is replaced with parameter value defined for according command. Definition [ :SYStem:] IPADDRess/? /<P> Allows setting the parameters: [ :SYStem:] IPADDRess 192.168.0.1
/?	Denotes the optional character “?” that is used if the command can also be used as a query. Example: Definition [ :SYStem:] IPADDRess/? /<P> “?” is used to query current IP Address of the device: IPADDR?;
/<wsp><P>	Denotes an optional parameter value preceded by a white space character.
:, *	Usage of Colon see 8.3.4
<wsp>	Denominates a white space character
<INT>	Integer value
<REAL>	Real value

## 8.6 GENERAL SCPI COMMANDS

SYNTAX	EXAMPLE	DESCRIPTION
*idn?	*idn?; COBRITE CBDX-NC- NN-NN-NN-FA, SN 19160001, F/W Ver 1.0.0(101), HW Ver 1.00;	Query System Type and Software version. The CoBrite DX is identified by CBDX. The CoBrite DX2 by CBDX2. The remaining string is determined by the laser configuration of the actual device. It matches the part number that is printed on the label on the unit.
*opc?	*opc?; 1;"	Query if all pending commands were executed. Note that this will NOT indicate if physical tuning of laser ports has been completed. Use <code>busy?</code> Query for this.
*rst	*rst;	Reset Controller; will warm start the instrument. All connections/sessions will be closed. Requires user level 1
*WAIt	*WAI; ;	Unit waits with response until *opc? is 1 and then acknowledge command. Eliminates need for polling loop of *opc? on remote side
*CLS	*CLS; ;	Clears all status/alarm registers of the unit. This command is used to clear latched alarm registers.

## 8.7 COMMANDS ON SYSTEM LEVEL

SYNTAX	READ WRITE	USER ACCESS LEVEL	PARAMETE R FORMAT	DESCRIPTION
[ :SYStem:]ECHO/?/<w sp><P>	RW	0	"0" or "1"	Sets or query echo command sent status, this setting applies to current session only
[ :SYStem:]DEFAULT	W	1	-	Resets user settings such as laser settings to factory default. This affects all settings including trigger configuration except Remote interface settings.
[ :SYStem:]STArtDEFA ult /?/<wsp><P>	RW	1	"0" or "1"	Queries/Sets if unit starts with last settings set before a reboot or with default of device. This affects all settings except Remote interface settings and Laser Port on/off status. 0 = Save each change of setting and restart with current config upon next reboot 1 = Always start with unit factory defaults
[ :SYStem:]ENABLeAUT OSTArt/?/<wsp><P>	RW	1	"0" or "1"	Enables or disables if laser port on/off status is saved and executed upon reboot.



SYNTAX	READ WRITE	USER ACCESS LEVEL	PARAMETER FORMAT	DESCRIPTION
				For laser safety reasons, the MX System does not allow this feature.
[ :SYStem:]INFORmation?	R	0	IDP-COBRITE, SN 19160001, F/W Ver 1.0.0(101), HW Ver 1.00;	see *idn? For detailed description
[ :SYStem:]DHCP/?/<wsp><P>	RW	1	“off” or “on”	configure DHCP Setting for Ethernet interface.
[ :SYStem:]IPADDRESS/?/<wsp><P>	RW	1	xxx.xxx.xxx.xx	IP Address Setting of Ethernet interface. DX & DX2 only
[ :SYStem:]NETMASK/?/<wsp><P>	RW	1	xxx.xxx.xxx.xx	Netmask Setting of Ethernet interface. DX & DX2 only
[ :SYStem:]GATEWAYIP/?/<wsp><P>	RW	1	xxx.xxx.xxx.xx	IP address for Gateway of Ethernet interface. DX & DX2 only
[ :SYStem:]USBIPADDRESS?	R	0	xxx.xxx.xxx.xx	IP Address of virtual Ethernet interface on USB
[ :SYStem:]USBNETMASK?	R	0	xxx.xxx.xxx.xx	Netmask Setting of virtual Ethernet interface on USB
[ :SYStem:]MACADDRESS?	R	0	XX:XX:XX:XX:XX:XX	Reads MAC Address of unit
[ :SYStem:]IPConfigDefault	W	1	-	Resets all settings of remote interfaces to factory defaults. This becomes effective only after a reboot of the unit.
[ :SYStem:]INTErfaceInit	W	0	-	Reset session parameters to defaults. Call this after opening the remote port. This command resets ECHO, PASS, FORMAT, UNIT:X, LINLOG, EVENT.
[ :SYStem:]REMOte?	R	0	“0” or “1”	Query remote status of device. Any open remote sessions via Ethernet?
[ :SYStem:]PASSword/?/<wsp><P>	RW	0	ASCII	Set new User level status by sending password or query current User level status

SYNTAX	READ WRITE	USER ACCESS LEVEL	PARAMETER FORMAT	DESCRIPTION
[ :SYSTem:]TIME?/ <wsp><P>	R/(W)	0	xxxxxxxx	Query or set system time. Note that time is set and tracked in volatile memory only. It requires to be set after each cold start.
[ :SYSTem:]ALARm?	R	0	<INT>	Query alarm status of device, see Alarm code definition 8.12 for details.
[ :SYSTem:]ERRor[:NEXT]?	R		-	Queries data in an error queue and deletes it from the queue.
[ :SYSTem:COMMunicate:]LOCKout/?	RW	1	"0" or "1"	Locks other sessions to perform write commands on the unit. It is automatically released if the active session closes
[ :SYSTem:COMMunicate:]ParameterREfresh?	R	0	<INT>	This query allows detecting if any change to the configuration was done. Each time the counter increases, the configuration was changed. This is useful in multi-user environments to detect if a parallel session has changed settings on the unit
[ :SYSTem:]IPConfCHanged?	R	0	0 1	Check if IP configuration of the Ethernet Interface was changed but no reboot was triggered yet to activate the new settings. This can be used to determine if the actual settings differ from the settings that will be active upon restart.
[ :]ABORt	W	0	-	Aborts all currently executed pending commands as fast as possible. Query *OPC? To determine status once all pending commands are aborted
[ :BOOT:]BootLoaDerRESet	W	0	-	Resets upload procedure for firmware upgrade. All data uploaded already is erased. New process can be restarted
[ :BOOT:]BootLoaDerAPPend	W	0	binary	send portions of the binary Firmware Image, each Byte is coded into 2 Characters 1..F, send max. 100 Bytes per command
[ :BOOT:]BootLoaDerEXECute/?	RW	0	-	Set: Executes upgrade of previously uploaded Firmware image. Query responds with current status of execution.

SYNTAX	READ WRITE	USER ACCESS LEVEL	PARAMETER FORMAT	DESCRIPTION
[ :SYSTem:]ENableLOGging/?	RW	R 0 W 1	"0" or "1"	This command enables local logging in the unit that can be used for debugging purposes. Enable this only if a persistent issue exists and ID Photonics asked you to enable the feature since this can slow down the performance of the instrument. The trace file read via RDEBUG is encrypted and cannot be checked by the user.
[ :SYSTem:]ReadDEBUG	R	0	-	Collects debug information from OSA which can be sent to ID Photonics for troubleshooting. Returns a maximum of 1000bytes per read. Responds "WAIT" as long as debug data is still collected. Responds "EOL" if all data is read.
[ :SYSTem:]IDENTify<wsp><P>	W	0	"0" or "1"	En- or disables blinking of the on the unit allowing identification of the unit attached to remote control.
[ :SYSTem:]LAYout?	R	0	-	Query chassis configuration. The response returns the chassis type and lists the installed slots and corresponding number of lasers. Example: lay? Response: CBDX, 1, 1, TLS1;
[ :SOURce:]TYPe?/<wsp><C>, <S>, <D>	R	0	-	Query Laser type present in addressed location. Use wildcard * to retrieve inventory of chassis. In case of wild card, port coordinates are reported as well. Example: type? 1, 1, 1 Response: NC
[ :SYSTem:]INTLock?	R	0	"0" or "1"	Query the status of the interlock setting. Optical output of lasers can only be enabled if the interlock jumper is set. 0: Laser can be activated
[ :SYSTem:]CARD:INFORMATION?<C>, <S>, <D>	R	0	<INT>	Query card level information. For DX chassis, the response is identical to *idn? Query
:SYSTem:RESet	W	1	-	Will reset instrument. Same as command *rst, see details in description of *rst

SYNTAX	READ WRITE	USER ACCESS LEVEL	PARAMETER FORMAT	DESCRIPTION
[ :SYStem:]SetPASS<w sp><P>	W	'	-	Sets a password to access the current user level. Requires current user level to be at the level that password is to be set. Parameter is a string defining the password.
[ :SYStem:]TEMP?	R	0	-	Query highest Laser base temperature and location in device.
[ :SYStem:]FAN?	R	0		Query the chassis fan level in % of max. level if a fan is present in chassis.
[ :SCRIPting:]WAITMi lliSeconds	W	1	<INT>	This command causes the unit to wait for specified time until the next command in buffer is executed. This is helpful if a batch of commands is uploaded to the unit for execution. Requires Firmware Version 1.2.1 or later

## 8.8 COMMUNICATION PORT SETTINGS

### 8.8.1 ALL

SYNTAX	READ WRITE	USER ACCESS LEVEL	PARAMETER FORMAT	DESCRIPTION
[ :SYStem:]DHCP/?/<w sp><P>	RW	1	"off" or "on"	configure DHCP Setting for Ethernet interface.
[ :SYStem:]USBIPADDR ess?	R	0	xxx.xxx.xxx.xxx	IP Address of virtual Ethernet interface on USB
[ :SYStem:]USBNETMASK?	R	0	xxx.xxx.xxx.xxx	Netmask Setting of virtual Ethernet interface on USB
[ :SYStem:]IPConfigDEFault	W	1	-	Resets all settings of remote interfaces to factory defaults. This becomes effective only after a reboot of the unit.
[ :SYStem:]INTerface Init	W	0	-	Reset session parameters to defaults. Call this after opening the remote port. This command resets ECHO, PASS, FORMAT, UNIT:X, LINLOG, EVENT.

### 8.8.2 COBRITE DX &DX2

SYNTAX	READ WRITE	USER ACCESS LEVEL	PARAMETER FORMAT	DESCRIPTION
[ :SYStem:] IPADDRESS /?/<wsp><P>	RW	1	xxx.xxx.xxx.xxx	IP Address Setting of Ethernet interface
[ :SYStem:] NETMASK/? /<wsp><P>	RW	1	xxx.xxx.xxx.xxx	Netmask Setting of Ethernet interface
[ :SYStem:] GATEWAYIP /?/<wsp><P>	RW	1	xxx.xxx.xxx.xxx	IP address for Gateway of Ethernet interface
[ :SYStem:] USBIPADDRESS?	R	0	xxx.xxx.xxx.xxx	IP Address of virtual Ethernet interface on USB
[ :SYStem:] USBNETMASK?	R	0	xxx.xxx.xxx.xxx	Netmask Setting of virtual Ethernet interface on USB
[ :SYStem:] MACADDRESS?	R	0	XX:XX:XX:XX:XX:XX	Reads MAC Address of physical Ethernet interface.

### 8.8.3 COBRITE MX

SYNTAX	READ WRITE	USER ACCESS LEVEL	PARAMETER FORMAT	DESCRIPTION
[ :SYStem:] IPADDRESS 1/?/<wsp><P>	RW	1	xxx.xxx.xxx.xxx	IP Address Setting of front panel Ethernet interface.
[ :SYStem:] NETMASK1/? /<wsp><P>	RW	1	xxx.xxx.xxx.xxx	Netmask Setting of front panel Ethernet interface.
[ :SYStem:] GATEWAYIP 1/?/<wsp><P>	RW	1	xxx.xxx.xxx.xxx	IP address for Gateway of front panel Ethernet interface.
[ :SYStem:] MACADDRESS 1?	R	0	XX:XX:XX:XX:XX:XX	Reads MAC Address of front panel Ethernet interface.
[ :SYStem:] IPADDRESS 2/?/<wsp><P>	RW	1	xxx.xxx.xxx.xxx	IP Address Setting of rear panel Ethernet interface.
[ :SYStem:] NETMASK2/? /<wsp><P>	RW	1	xxx.xxx.xxx.xxx	Netmask Setting of rear panel Ethernet interface.
[ :SYStem:] GATEWAYIP 2/?/<wsp><P>	RW	1	xxx.xxx.xxx.xxx	IP address for Gateway of rear panel Ethernet interface.

SYNTAX	READ WRITE	USER ACCESS LEVEL	PARAMETER FORMAT	DESCRIPTION
[ :SYStem:]MACADDRESS2?	R	0	XX:XX:XX:XX:XX: XX	Reads MAC Address of rear panel Ethernet interface.

### 8.9 TRIGGER COMMANDS, DX &DX2 ONLY

All trigger commands require user access level 1 and read and writable.

PORT coordinate per common definition: <C>, <S>, <D>

SYNTAX	PARAMETER FORMAT	DESCRIPTION
[ :SYStem:]TRIGGERDelay/?<wsp>/<P>	<INT>	'Queries/Sets trigger delay for scan trigger IN. Setting the delay will cause the laser tuning process to be delayed relative to the trigger event by the parameter given in Milliseconds. The 0 Setting will cause the scan to be started without delay.
[ :SYStem:]TRIGGERPolarity/?<wsp>/<P>	{IN, OUT}, 0 = ACTIVE LOW; 1 = ACTIVE HIGH	Queries/Sets trigger signal polarity of input/output. Trigger IN: 1 (Active high, default) means that a high-level signal triggers a new scan if enabled, 0 will cause a low signal to trigger a new measurement. Trigger OUT: 1 (Active high, default) means that a high-level signal is generated if a scan is complete and available to read, it will return low once the next scan is started. The Signal is low if no scan was performed yet. The 0 setting will cause the output to be low if a scan is completed and high again once a new scan is triggered. The signal is high if no scan was performed yet. Example: TRIPOL IN, 1;
[ :SOURce:]TRIGGEROUTACTIve/?/<wsp><C>, <S>, <D>, /<P>	{0, 1}	Queries/Sets trigger output signal to be used for laser port. 0: Laser Port tuning state will not change Trigger Output state. 1: Laser Port tuning state will be used for logical Trigger Output state. Example: TROUTACT 1, 1, 1, 1;
[ :SOURce:]TRIGGERCONFIguration/?/<wsp><C>, <S>, <D>, /<P>	See details of command [ :SOURce:]CONFIguration	Set or Query current configuration of Laser in location C-S-D in csv format that is executed if a trigger signal is detected at the Hardware Trigger Input port. This command will be buffered until either the trigger is executed. The parameters for this command are identical to the command [ :SOURce:]CONFIguration. If a new Laser Port setting using a command such as conf, wav, frequ, onof is sent, the buffer filled by triconf is cleared. An empty response to "the triconf?" query indicates that the buffer is empty.

## 8.10 LASER PORT COMMANDS

COMMAND	TYPE
[ :SOURce:]WAVelength/?/<wsp><C>, <S>, <D>, /<P>	<REAL>nm
Sets or queries the wavelength setting of a tunable laser port. Value format is in Nanometer. Example: WAV 1550.012; sets Laser Port 1,1,1 to 1550.012nm	
[ :SOURce:]WAVelength:LIMit?/<wsp><C>, <S>, <D>	<REAL>nm
Queries the wavelength setting limits of a tunable laser port. Value format is in Nanometer. Example: WAV:LIM?; queries Laser Port 1,1,1 Response with min and maximum limit: 1528, 1565;	
[ :SOURce:]FREQuency/?/<wsp><C>, <S>, <D>, /<P>	<REAL>THz
Sets or queries the wavelength setting of a tunable laser port. Value format is in Tera Hertz. Example: FREQ 192.15; sets Laser Port 1,1,1 to 192.15THz.	
[ :SOURce:]FREQuency:LIMit?/<wsp><C>, <S>, <D>	<REAL>THz
Queries the frequency setting limits of a tunable laser port. Value format is in Tera Hertz. Example: FREQ:LIM?; queries Laser Port 1,1,1. 2 value Response with min and maximum limit: 191.1020, 196.1020;	
[ :SOURce:]OFFset/?/<wsp><C>, <S>, <D>, /<P>	<REAL>GHz
Sets or queries the frequency offset setting of a tunable laser port. Value format is in Giga Hertz. Example: OFF 11.15; sets Laser Port 1,1,1 offset to 11.15 GHz. Value can be positive or negative.	
[ :SOURce:]OFFset:LIMit?/<wsp><C>, <S>, <D>	<REAL>GHz
Queries the offset setting limits of a tunable laser port. Value format is in Giga Hertz. Example: OFF:LIM?; queries Laser Port 1,1,1 Response 12; It is a single value since the offset is symmetrical to 0.	
[ :SOURce:]POWer/?/<wsp><C>, <S>, <D>, /<P>	<REAL>dBm
Sets or queries the optical output power <b>target</b> setting of a tunable laser port. Value format is in dBm. Example: POW 11.15; sets Laser Port 1,1,1 power of 11.15dBm	
[ :SOURce:]ActualPOWer?/<wsp><C>, <S>, <D>	<REAL>dBm
Queries the <b>current</b> optical output power reading of a tunable laser port. Value format is in dBm. Example: APOW?; 11.15; queries the Laser Port 1,1,1 answer is 11.15dBm	
[ :SOURce:]LIMit?/<wsp><C>, <S>, <D>	<REAL>
Query maximum tuning Parameters of Laser in location C-S-D in csv format. <Minimum Frequency>,<Maximum Frequency>,<Fine tuning Range>,<Minimum Power>,<Maximum Power> Example: LIM?; queries Laser Port 1,1,1	
[ :SOURce:]CONFIguration/?/<wsp><C>, <S>, <D>, /<P>	<REAL>

COMMAND	TYPE
<p>Set or Query current configuration of Laser in location C-S-D in csv format:            &lt;Frequency&gt;,&lt;Offset&gt;,&lt;Output Power&gt;,&lt;Output state&gt;,&lt;Busy state&gt;,&lt; Dither state&gt;,            Busy state : &lt;INT&gt; "1","0", Only for query, if set is used, this parameter is omitted            Dither state: &lt;INT&gt; "1","0","-1" If queried and "-1" is reported, laser does not support this feature. If set and laser does not support the feature, the parameter setting must be "-1".</p> <p><b>Example read:</b> SOUR:CONF? 1,2,3; returns            191.42,10.134,6.12,0,1,-1;            The laser is set to 191.42THz, 10.134GHz FTF, 6.12dBm, output on (1) , not busy tuning (0), dither not supported(-1)</p> <p><b>Example write:</b> SOUR:CONF 1,1,1,193,1,7,1,-1; will set the to 193THz, Fine tuning 1GHz, 7dBm output power, 1: laser on, 1: dither not supported.</p> <p>Note: For SC Type lasers, Frequency and offset cannot be changed within a single command. Use 2 commands to set them separately.</p>	
<pre>[ :SOURce:]BUSY?/&lt;wsp&gt;&lt;C&gt;,&lt;S&gt;,&lt;D&gt;</pre>	<INT>
<p>Query if laser port is currently tuned "1" or settled "0".</p>	
<pre>[ :SOURce:]STATe/?/&lt;wsp&gt;&lt;C&gt;,&lt;S&gt;,&lt;D&gt;,&lt;/P&gt;</pre>	<INT>
<p>Query if laser is on "1" or off "0"</p>	
<pre>[ :SOURce:]MONitor?/&lt;wsp&gt;&lt;C&gt;,&lt;S&gt;,&lt;D&gt;</pre>	<REAL>
<p>Query monitor readings from laser. Response: &lt;LD chip Temperature&gt;, format nn.nn, unit °C &lt;LD base Temperature&gt;, format nnnn.n, unit mA &lt;LD chip current&gt;, format nnnn.n, unit mA &lt;TEC current&gt;, format nnnn.n, unit mA            Example: MON? 1,2,3; Returns 29.23,25.12,125.1,1043.2</p>	
<pre>[ :SOURce:]LaserALARm?/&lt;wsp&gt;&lt;C&gt;,&lt;S&gt;,&lt;D&gt;</pre>	<INT>
<p>Query alarm status of laser port(s), see Alarm code definition 8.12 for details. The alarm codes are identical to the system level command alar? but on port level.            Example: lalar? 1,2,3; Returns 0 if laser 1,2,3 has no error.</p>	
<pre>[ :SOURce:]BusyWAIt/&lt;wsp&gt;&lt;C&gt;,&lt;S&gt;,&lt;D&gt;</pre>	-
<p>Unit will acknowledge once selected laser ports have finished tuning. Use this to avoid polling busy status in while loop. Needs response timeout on host side &gt; tuning time of laser (we recommend 20s). Use wild card to query for multiple ports.            Example: bwai 1,2,3; Returns ; after laser 1,2,3 has finished tuning            bwai *,*,*; Returns ; after all lasers have finished tuning            bwai; Returns ; after laser 1,1,1 has finished tuning</p>	

## 8.10.1 COMMAND PROPERTY OVERVIEW

### 8.10.1.1 SYSTEM LEVEL COMMANDS

Session based parameters/commands will be initialized to default each time a new connection/session is opened to the instrument.



SYNTAX	READ WRIT E	USER ACCESS LEVEL	SESSION BASED	DEFAULT VALUE	STORED IF STADEF =0
[ :SYStem:]ECHO/?/<wsp><P>	RW	0	X	0	-
[ :SYStem:]STArtDEFault /?/<wsp><P>	RW	1	-	1	-
[ :SYStem:]DEFAULT	W		-	-	-
[ :SYStem:]INFORmation?	R	0	-	-	-
[ :SYStem:]DHCP/?/<wsp><P>	RW	1	-	OFF	-
[ :SYStem:]IPADDRess/?/<wsp> <P>	RW	1	-	192.168.0.1	-
[ :SYStem:]NETMASK/?/<wsp><P >	RW	1	-	255.255.255.0	-
[ :SYStem:]GATEWAYIP/?/<wsp> <P>	RW	1	-	192.168.0.255	-
[ :SYStem:]IPADDRess1/?/<wsp> ><P>	RW	1	-	192.168.0.1	-
[ :SYStem:]NETMASK1/?/<wsp>< P>	RW	1	-	255.255.255.0	-
[ :SYStem:]GATEWAYIP1/?/<wsp> ><P>	RW	1	-	192.168.0.255	-
[ :SYStem:]IPADDRess2/?/<wsp> ><P>	RW	1	-	192.168.0.1	-
[ :SYStem:]NETMASK2/?/<wsp>< P>	RW	1	-	255.255.255.0	-
[ :SYStem:]GATEWAYIP2/?/<wsp> ><P>	RW	1	-	192.168.0.255	-
[ :SYStem:]MACADDRESS?	R	0	-	-	-
[ :SYStem:]IPConfigDEFault	W	1	-	-	-
[ :SYStem:]INTErfaceInit	W	0	-	-	-
[ :SYStem:]REMOte?	R	0	-	-	-
[ :SYStem:]PASSword/?/<wsp>< P>	RW	0	X	-	-

SYNTAX	READ WRIT E	USER ACCESS LEVEL	SESSION BASED	DEFAULT VALUE	STORED IF STADEF =0
[ :SYStem:]TIME? /<wsp><P>	R/(W)	0	-	-	-
[ :SYStem:]ALARm?	R	0	-	-	-
[ :SYStem:]STATUs?	R	0	-	-	-
[ :SYStem:]ERRor[:NEXT]?	R		-	-	-
[ :SYStem:COMMunicate:]LOCKo ut/?	RW	1	-	0	-
[ :SYStem:COMMunicate:]Param eterREFresh?	R	0	-	0	-
[ :STATUs:OPERation:]EVENT?	R	0	-	-	-
[ :]ABORt	W	0	-	-	-
[ :BOOT:]BootLoaDerRESet	W	0	-	-	-
[ :BOOT:] BootLoaDerAPPend	W	0	-	-	-
[ :BOOT:]BootLoaDerEXECute/?	RW	0	-	-	-
[ :SYStem:]ENableLOGging/?	RW	1	-	0	-
[ :SYStem:]ReadDEBUG	R	0	-	-	-
[ :SYStem:]IDENtify<wsp><P>	W	0	-	0	-
[ :SYStem:]ENABLEAUTOSTArt/? /<wsp><P>	RW	1	-	0	-
[ :SYStem:]STArtDEFault /?/<wsp><P>	RW	1	-	1	-
[ :SYStem:]SetPASS<wsp>,<P>, <P>	W	-	-	1	-
[ :SYStem:]TEMP?	R	0	-	-	-
[ :SYStem:]FAN?	R	0	-	-	-

### 8.10.1.2 LASER PORT COMMANDS

COMMAND	READ WRIT E	USER ACCESS LEVEL	STORED IF STADEF =0
[ :SOURce:]WAVelength/?/<wsp><C>,<S>,<D>,</P>	RW	0	✓
[ :SOURce:]WAVelength:LIMit? /<wsp><C>,<S>,<D>	R	0	-
[ :SOURce:]FREQuency/?/<wsp><C>,<S>,<D>,</P>	RW	0	✓
[ :SOURce:]FREQuency:LIMit?/<wsp><C>,<S>,<D>	R	0	-
[ :SOURce:]OFFset/?/<wsp><C>,<S>,<D>,</P>	RW	0	✓
[ :SOURce:]OFFset:LIMit?/<wsp><C>,<S>,<D>	R	0	-
[ :SOURce:]POWer/?/<wsp><C>,<S>,<D>,</P>	RW	0	✓
[ :SOURce:]ActualPOWer?/<wsp><C>,<S>,<D>	R	0	-
[ :SOURce:]POWer:LIMit?/<wsp><C>,<S>,<D>	R	0	-
[ :SOURce:]LIMit?/<wsp><C>,<S>,<D>	R	0	-
[ :SOURce:]CONFIguration/?/<wsp><C>,<S>,<D>,</P>	RW	0	✓
[ :SOURce:]BUSY?/<wsp><C>,<S>,<D>	R	0	-
[ :SOURce:]STATe/?/<wsp><C>,<S>,<D>,</P>	RW	0	✓
[ :SOURce:]MONitor?/<wsp><C>,<S>,<D>	R	0	-
[ :SOURce:]LaserALARm?/<wsp><C>,<S>,<D>	R	0	-
[ :SOURce:]BusyWAIt/<wsp><C>,<S>,<D>	R	0	-

### 8.11 SCPI CODE ERROR DEFINITION

ERROR #	DESCRIPTION
100	Command Syntax Command error
101	Parameter out of range
102	No data in buffer

ERROR #	DESCRIPTION
103	device not ready
104	user level for this command not sufficient
200	Command execution error
201	user level rights to execute this command not sufficient, increase using PASS command
250	
251	
252	

### 8.12 ALARM CODE DEFINITION

The following table details potential alarms raised by the unit. The alarm status can be queried using the “alar?” command with is the logically “or” of the alarm status of each laser port present in the system. Individual lasers can be queried using the command LALAR?/<wsp><C>,<S>,<D> The response is an ASCII coded unsigned 16-bit integer number, little endian. Convert this number into binary format to retrieve the alarm status. Each “1” bit represents an active alarm.

Note that the alarm register is latched. So, any alarm, is monitored since either boot of unit or last \*cls command. In order to determine if an alarm is currently present, send an \*cls command before query. Use the SCPI Command “\*cls” to clear all latched alarms.

BIT #	ALARM	CONDITION/DESCRIPTION
0	Laser Temperature too high	Base temperature of one or more laser ports exceeds max. threshold. Laser is de-activated to protect Hardware.
1	Interlock while Laser On	Interlock safety switch was opened while at least one laser port was enabled causing the laser port to be switched off according to safety rules.
2	Controller communication Failure	Main Controller cannot communicate with other internal components of the unit.
3	Laser error	One or more lasers report an error. Download service log and provide it to ID Photonics
4	Not used	
5	Not used	
6	Not used	
7	Not used	
8	Not used	

BIT #	ALARM	CONDITION/DESCRIPTION
9	Not used	
10	Not used	
11	Not used	
12	Not used	
13	Not used	
14	Not used	
15	Not used	

The logo for IDPHOTONICS GMBH, featuring the company name in a blue, sans-serif font. The 'O' in 'PHOTONICS' is stylized with a circular arrow around it. The letters 'GMBH' are smaller and positioned to the right of 'PHOTONICS'.

**IDPHOTONICS** GMBH

# SHAPING LIGHT.

HELPING ENGINEERS AND  
SCIENTISTS IN  
ADVANCING HOW THE  
WORLD COMMUNICATES,  
SENSES AND CONNECTS



TUNABLE  
LASER



TRANSMITTER  
SOLUTIONS

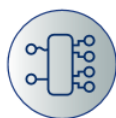

RECEIVER  
SOLUTIONS



SPECTRAL  
ANALYSIS



Anton-Bruckner-Strasse 6  
85579 Neubiberg  
GERMANY  
Tel: +49-89-201 899 16  
[info@id-photonics.com](mailto:info@id-photonics.com)  
[id-photonics.com](http://id-photonics.com)

All rights reserved. No part of this publication may be reproduced, stored in a retrieval system or transmitted in any form, be it electronically, mechanically, or by any other means such as photocopying, recording or otherwise, without the prior written permission of ID Photonics GmbH. Information provided by ID Photonics GmbH is believed to be accurate and reliable. However, no responsibility is assumed by ID Photonics GmbH for its use nor for any infringements of patents or other rights of third parties that may result from its use. No license is granted by implication or otherwise under any patent rights of ID Photonics GmbH. The information contained in this publication is subject to change without notice.