



OMFT - OPTICAL MULTI-FORMAT TRANSMITTER TRANSMITTER SOLUTIONS

USER MANUAL



OMFT

P/N OMFT-x-0x-FA
x: Wildcard, applies to all instruments

Status: 2024-12-19
Applies to Firmware 2.3.4 or later

info@id-photonics.com
id-photonics.com

CONTENT

1	General Information	3
2	Quick start	7
3	Overview	10
4	Hardware Setup	13
5	Tunable Laser Option	18
6	Software	19
7	Remote Control	26
8	Appendix	40

1 GENERAL INFORMATION

1.1 COMPLIANCE STATEMENT ELECTROMAGNETIC COMPATIBILITY AND DEVICE SAFETY

Hereby, we declare that this system has been designed and tested for compliance for the following directives.

1.1.1 INTERNATIONAL

IEC 62368-1

CISPR 11:2003 in accordance with EN 61326-1: 2006

1.1.2 UNITED STATES OF AMERICA

FCC 47 CFR Part 15, Subpart B Class A, Measurement process ANSI C63.4 (2009)

1.1.3 EUROPEAN UNION

EN 55022:2011

EN 61326-1: 2013

EN 61000-6-2: 2006

EN 61000-6-4: 2011

EN 61000-3-2: 2010

EN 61000-3-3: 2009

This conformity statement for includes EU directive 2002/95/EG (RoHS) and EU directive EG1907/2006 (REACH).

1.2 LIMITATION OF COMMUNICATION INTERFACES

Operation of all USB Ports is limited to a maximum cable length of 3 m and a maximum length of 30 m for all Ethernet ports present.

1.3 EUROPEAN WEEE DIRECTIVE COMPLIANCE

ID PHOTONICS has established processes in compliance with the Waste Electrical and Electronic Equipment (WEEE) directive, 2002/96/EC. This product should not be disposed of as unsorted municipal waste and should be collected separately and disposed of according to your national regulations. In the European Union, all equipment purchased from ID PHOTONICS can be returned for disposal at the end of its useful life. ID PHOTONICS will ensure that all waste equipment returned is reused, recycled, or disposed of in an environmentally friendly manner, and in compliance with all applicable national and international waste legislation. It is the responsibility of the equipment owner to return the equipment to ID PHOTONICS for appropriate disposal. If the equipment was imported by a reseller whose name or logo is marked on the equipment, then the owner should return the equipment directly to the reseller. If you have questions concerning disposal of your equipment, contact ID PHOTONICS's at WEEE@id-photonics.com.

1.4 LINE VOLTAGE SELECTION

The unit operates from any single-phase AC power source that supplies 100 ~ 240 VAC at a frequency of 50/60 Hz. The input line voltage setting is done automatically by the internal power supply.

1.5 SERVICE

Do not attempt to service or adjust this instrument unless an authorized person is present. Do not install substitute parts or perform any unauthorized modifications to this instrument. Contact ID Photonics or your local distributor to obtain service support.

1.6 HELP AND USER FEEDBACK

ID Photonics GmbH is dedicated to continuously improve customer experience of our products. Thus, if you have any feedback that might help us to improve our products send us an E-Mail to: feedback@id-photonics.com.

1.7 SAFETY

1.7.1 GENERAL SAFETY PRECAUTIONS

The following general safety precautions must be observed during all phases of operation of this instrument. Failure to comply with these precautions or with specific warnings elsewhere in this manual violates safety standards of design, manufacture, and intended use of the instrument.

ID Photonics assumes no liability for the customer's failure to comply with these requirements.

Before operation, review the instrument and manual for safety markings and instructions. You must follow these to ensure safe operation and to maintain the instrument in safe condition.

1.7.2 GENERAL

This product is a Safety Class 1 instrument (provided with a protective earth terminal). The protective features of this product may be impaired if it is used in a manner not specified in the operation instructions.

1.7.3 ENVIRONMENT CONDITIONS

This instrument is intended for indoor use in an installation category II, pollution degree 2 environment. It is designed to operate at a maximum relative humidity of 95% and at altitudes of up to 2000 meters.

Refer to the specification's tables in the inspection report for the ac mains voltage requirements and ambient operating temperature range.

NOTE

Before connecting electrical power to the unit, make sure the unit could acclimatize to ambient temperature for at least 2 hours to avoid damage by i. e. condensed humidity on electrical parts inside the unit.

1.7.4 FUSE REPLACEMENT

For continued protection against the possibility of fire, replace the fuse only with a fuse of the specified voltage, current and type ratings.

1.7.5 BEFORE APPLYING POWER

Verify that all safety precautions are taken. The power cable inlet of the instrument serves as a device to disconnect from the mains in case of hazard. The instrument must be positioned so that the operator can easily access the power cable inlet. When the instrument is rack mounted the rack must be provided with an easily accessible mains switch.

1.7.6 MAXIMUM RATINGS

ALWAYS operate the unit within the maximum ratings listed in section **Fehler! Verweisquelle konnte nicht gefunden werden.** Ignoring these limits may result in permanent damage to the unit and loss of warranty.

1.7.7 GROUND THE INSTRUMENT

To minimize shock hazard, the instrument chassis and cover must be connected to an electrical protective earth ground. The instrument must be connected to the ac power mains through a grounded power cable, with the ground wire firmly connected to an electrical ground (safety ground) at the power outlet. Any interruption of the protective (grounding) conductor or disconnection of the protective earth terminal will cause a potential shock hazard that could result in personal injury.

1.7.8 DO NOT OPERATE IN AN EXPLOSIVE ATMOSPHERE

Do not operate the instrument in the presence of flammable gases or fumes.

1.7.9 DO NOT REMOVE THE INSTRUMENT COVER

Keep away from live circuits inside the equipment. Operating personnel must not remove equipment covers. Opening the instrument will result in loss of all warranty given for the instrument and may exhibit lethal health risks.

Only factory authorized service personnel or other qualified service personnel may remove equipment covers for internal subassembly or component replacement or any internal adjustment. Do not install substitute parts or perform any unauthorized modification of the equipment or the warranty may be voided.

Instruments that appear damaged or defective should be made inoperative and secured against unintended operation until they can be repaired by qualified service personnel.

1.7.10 VENTILATION

Keep a space of 30 cm or more between the rear side of the device and any other objects such as walls to guarantee sufficient cooling of the device.

Never block the air fan and ventilation openings.

1.7.11 CLEANING THE INSTRUMENT

To avoid personal injury, power down the device and disconnect it from line voltage before performing any of the following procedures.

To clean the exterior surface, perform the following steps:

- Remove loose dust on the outside of the instrument with a lint-free cloth.

- Use a soft cloth dampened with water to clean the device. Use 75% isopropyl alcohol solution as a cleaner.

- Do not use any abrasive or chemical cleaning agents.

1.7.12 SAFETY SYMBOLS ON INSTRUMENTS

1.7.12.1 WARNING OR CAUTION



If you see this symbol on the product, you must refer to the manual for specific Warning or Caution information to avoid personal injury or damage to the product.

1.7.12.2 ESD SAFETY WARNING



This sign indicates that the respective modules, boards or RF inputs and outputs are susceptible to damage by electro static discharge (ESD), and require proper protection procedures for storage and handling. Refer to the manual for the necessary protection procedures.

1.7.12.3 OUTPUT OF LASER RADIATION WARNING



This unit can contain an active source of laser radiation, if the option “internal laser source” is installed, that may cause harm to the eye. Please refer to section 0 for laser safety warning.

Please note that even if the unit has no internal laser source installed, it can be connected to external laser sources such that some ports can radiate laser light in such a configuration. Device output ports, which potentially emit laser radiation, are indicated by this sign:

1.7.12.4 WEAR EYE PROTECTION

Wear eye protection if exposure to high-intensity rays or laser radiation exists.

1.7.12.5 DO NOT DIRECTLY VIEW OPTICAL MODULATOR OUTPUT

Under no circumstances should you use any optical instruments to view the laser output (optional) or optical modulator output directly.

1.7.12.6 WARNING LASER SAFETY

INVISIBLE LASER RADIATION
DO NOT VIEW WITH
OPTICAL INSTRUMENTS
CLASS 1M LASER PRODUCT
(IEC 60825-1/2007)

The laser sources specified by this user guide are classified according to IEC 60825-1 (2007) Laser Notice No. 50 dated 2007-June-24 and comply with CFR 1040.10 except deviations per Laser Notice No. 50, July 2001 Key Feature Number 4.

Do not view the laser output from this device directly with optical instruments (e.g., eye loupes, magnifiers, microscopes). Viewing the laser output with certain optical instruments within a distance of 100mm may pose an eye hazard. The class 1M laser product definition is based on all conditions defined in this section.

Please pay attention to the following laser safety warning: Under no circumstances look into the end of an optical cable attached to the optical outputs when the device is operational. The laser radiation can seriously damage your eyesight. Do not enable the laser when there is no fiber attached to the optical output ports. The laser is enabled by pressing the 'Laser on' button in the operating software delivered with the instrument. The laser is on when the virtual red LED in the front panel of the instrument is lit. The use of optical instruments with this product will increase eye hazard.

In doubt about laser safety requirements consult a trained laser safety instructor for local safety requirements of this product.

1.7.12.7 OPTICAL OUTPUT OF LASER PORT

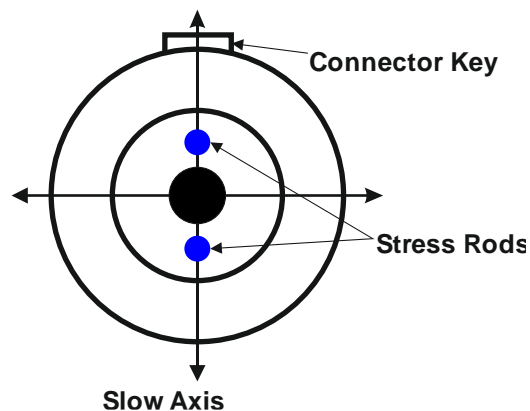

The laser port, only installed on devices containing the optional internal laser source, features a polarization maintaining fiber output which can be both used with standard single mode fibers and polarization maintaining fibers.

1.7.12.8 PRECAUTIONS WITH CONNECTORS

It is essential to ensure that all optical and electrical connectors are in good condition. Dirty connectors can lead to poor performance, while broken connectors can cause damage to other equipment!

Before using a microwave connector, check it visually, using an optical microscope (20x magnification is recommended). If the connector needs to be cleaned, swab it with clean isopropyl alcohol. Dry the connector by blowing it with clean compressed air or nitrogen.

Microwave connectors must be tightened with a torque wrench. Overtightening connectors can damage the thread and render the connector unusable!

Before an optical connector is used, check it visually by using an optical microscope as recommended by the manufacturer of the connector. Please pay attention to the laser safety warning in section 0 before inspecting optical connectors. If the connector needs to be cleaned, apply the cleaning procedure recommended by the manufacturer of the connector.

Make sure you are familiar with these issues to avoid damage to your device and possible violation of warranty.

NOTE

Before connecting the inputs or outputs to any measurement equipment or device under test, make sure that a suitable attenuator, if necessary, is fitted. The maximum levels of each individual input/output are shown in section 8

2 QUICK START

This section contains redundant information from other chapters but is useful for a first-time usage of the instrument.

- Insert power cord to power cord socket located at read side of the unit (6).

! NOTE

Do not turn-on OMFT, before hardware setup is completed!

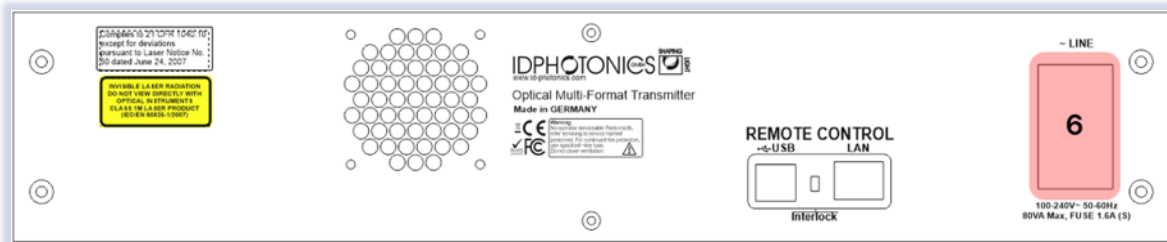

- Connect the optical input (2) of the Modulator to the laser output port (1) using the supplied PM Patch cord or an external laser source. Connect the modulator output to your setup (3)).

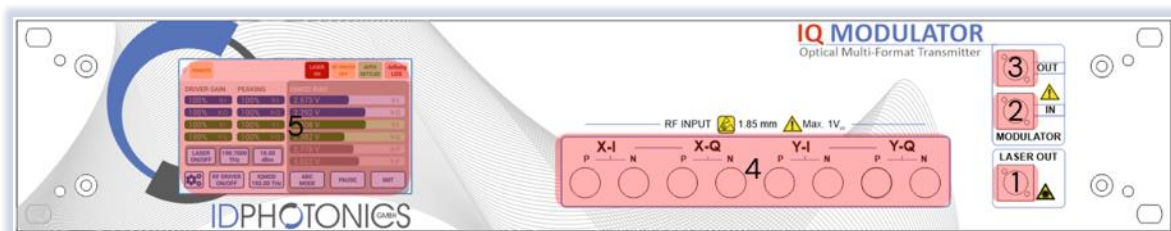

! NOTE

- Never exceed the maximum optical input power.
- Use only matching fiber connectors.
- Refer to inspection report for connector type installed in actual sample.
- Never open or close optical fiber connection when optical power is on.
- Never expose to laser radiation.
- Ensure clean fiber facets, when connecting.

Make sure that the input polarization to the modulator is preserved by using PM Patch cords and a laser source with PM output. Use the blue PM Jumper Fiber provided with the unit for this task.

- Attach eight electrical RF cables to the RF inputs (4) and connect it to your RF electrical signal source (the RF signal source is not part of this product).

! NOTE

- If you plan to drive the unit single ended, make sure to properly terminate the unused RF ports by suitable 50 Ohm RF terminators
- Make sure the RF signal source output is disabled
- Ensure proper skew-matched cables at the OMFT input plane.
- Never exceed the maximum RF input voltage swing.

- Turn-off the OMFT internal RF amplifiers as well as the external RF signal source when changing the electrical cabling.
- Use RF cables with matching connectors. Refer to inspection report for connector type installed in actual sample.
- **Switch on the OMFT** using the switch located at the rear panel next to the power socket (6)

! NOTE

Turn-off any optical amplifier subsequent to the OMFT in case:

- The OMFT is started or shut down
 - The bias controller is reset or bias values are restored
 - The electrical signal source is turned on or off
 - The electrical signals are changed
 - The optical input signals are changed or turned on/off
- **The unit will indicate its readiness in the local touch panel (5). The RF amplifier outputs and laser out are switched off by default.**
 - **Set the IQMOD Frequency to the value set to same value as the laser source that is used.** If the internal laser is used, there is an option to automatically synchronize the settings.
 - **Enable the laser source connected to the OMFT IQ Modulator setting 16 dBm as target power.** This is typically the internal laser of the unit. Make sure to never exceed a maximum total input power defined in the maximum ratings of the instrument. If the internal laser is used, set the desired frequency and power to the laser and enable the output by pressing the laser “Laser on” button on the local touch panel for about 2 seconds(5). Wait for the laser to finish tuning indicated by “Laser on” indicator.



- **Enable the Automatic BIAS Control (ABC)** by pressing the button “ABC MODE”. The ABC will start the optimization process indicated by a variation of the 6 displayed Voltages.
- **Setup the AWG RF Signal properly.** See Section 8.1 for some reference settings of a typical setup using a Keysight AWG.
Typical good settings are: RF input swing V_{pp} differential = 250mV, V_{pp} single ended = 500mV, OMFT Driver Gain = 30% (Class 40) or 70% (Class 60), Peaking of 0% to 50%.
The unit does have calibrated default RF driver settings which are suitable to achieve good results for most applications.
Make sure to properly include the inter-channel skew of the OMFT into the waveform generation. The OMFT internal skew is implemented in the supplied S2P Files or can be found in the inspection report of the unit at

hand. Both can also be retrieved from the Web GUI (Dropdown Files in upper right-hand corner) or by plugging in the USB connection which installs a Mass Storage device on the host PC ("USB Stick").

- **Switch on the RF signal source connected to the OMFT (the RF signal source is not part of this product)**
- **Enable the OMFT internal RF drivers by pressing "RF driver on/off" for 2 seconds. The RF driver indicator should read "RF driver on" now.**
The LOS (Loss of signal) indicator in the touch panel should now deactivate to indicate that optical power is detected at the output of the Modulator. The ABC will continue to optimize its BIAS Point now.
- **Make sure that the Automatic BIAS Control is enabled by pressing "ABC Mode" to let the OMFT find the optimum operating point of the modulator. This process can take a few seconds up to 3 Minutes. The unit will indicate "ABC settled" once the process is complete**
 - The Voltages shown in the box "IQMod BIAS" should now be changing constantly, the factory default start values are close the optimal values already. Wait for "Auto Settled" indicator to become "green". The voltages should now be changing in very small steps only.
 - Wait for about 60 seconds until the upper status indicator declares "ABC settled" or "ABC paused". This is close to optimum but paused because the feedback signal is below -25dBm which is the Loss of Signal (LOS) threshold.
 - Validate that the ABC status indicator changed from "INIT" and then "Auto" to "Auto Settled" and "LOS Status" indicate "green" and "Alarm pending" indicator is off.

NOTE

In Auto mode with no RF Power applied to the IQMOD (RF Amp off and/or RF signal source out off), the ABC will control to the transmission minimum causing the output power to drop below -25dBm or a "LOS" and "Auto Pause" since no modulation of the IQMOD is performed.

- The unit is ready now and the optical constellation can be detected.

2.1 REFERENCE VALUES

For a 32 GBaud/s PDM-QAM32 signal and a Laser source power of +16 dBm, the default gain settings of the RF drivers, Vpp differential = 250mV, Vpp single ended = 500mV for the RF signal source, the typical average output power of the OMFT should be in the range of -10 to -13dBm.

2.2 ACCESS OF WEBGUI

Connect the USB Port located at the rear of the unit to your Windows10 PC or connect the Ethernet Port to your LAN.

1. **For USB** based access, all drivers will be installed automatically, Windows device manager should show now 3 devices:
 1. A storage device containing manual etc.
 2. A virtual Ethernet Interface "RNDIS"
 3. A virtual COM PortBoth virtual COM and Ethernet Ports can be used to remote control the unit. The installed COM Port number can be retrieved from Windows device manager.
To access the WebGUI, the USB virtual Ethernet IP address is needed. If the DNS configuration of your computer allows, the IP address can also be retrieved by entering the command shell "ping omft.local" or retrieve it from the label located on back of the unit. For a DX chassis, it can also be retrieved via the Touch panel under "Device Setup".
2. **For Ethernet** based access, the default IP of the unit is 192.168.0.1. Make sure that the host PC IP is in the same subnet as the laser unit (192.168.0.x). If this is not the case, you can change the IP settings of the unit via the touch screen or using the USB Port of the unit. Use <http://omft.local/> as an

alternative to the IP address to connect to the unit if your DNS configuration of the network allows this access.

3. Open your Web browser, enter <http://omft.local/> or the IP address in the address field of the browser and hit <enter>. The Webpage allowing to control the laser remotely should open now.

Note: Depending on the configuration of your host PC DNS structure, the <http://omft.local/> name representation might not be resolved into the correct IP address. In such a case, for a DX unit, retrieve the IP Address on the local touch panel under “Device Config – Network Config” and use it instead of the name. For a DX2 unit, open a connection to the USB virtual serial interface and type the command “USBIPADDR?;” to retrieve the USB IP Address or “IPADDR?;” for the IP address of the Ethernet interface or retrieve the IP address from the type label located on the unit. Note that not all units have this information printed on.

3 OVERVIEW

The Optical Multi-Format Transmitter (OMFT) enables modulation of single or multiple optical carriers with various modulation formats, such as polarization-division multiplexed quaternary phase-shift keying (PDM-QPSK) or 16-ary quadrature amplitude modulation (PDM 16-QAM).

3.1 BLOCK DIAGRAM

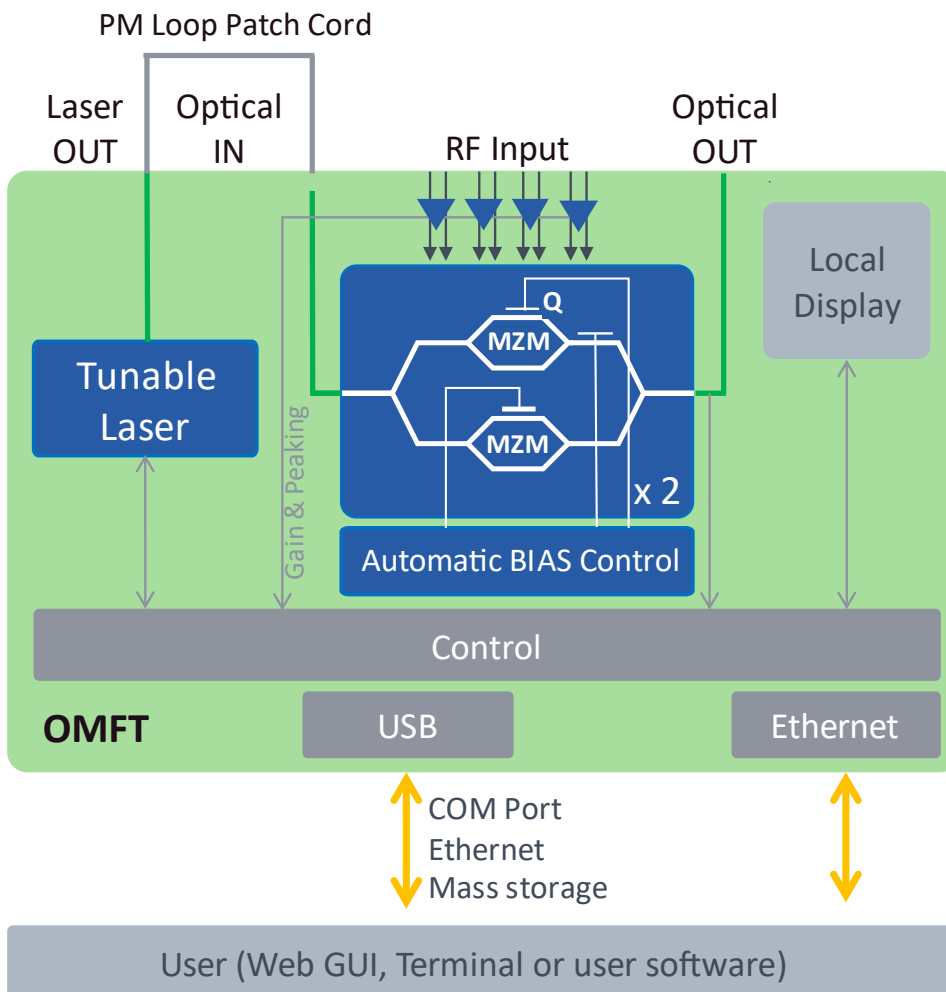

3.2 RF CHAIN

For that purpose, the OMFT amplifies four externally provided electrical drive signals (in-phase and quadrature drive signals for x- and y-polarization, respectively, generated by e.g. an arbitrary waveform generator or bit pattern generator) and subsequently converts them to the optical domain by means of an electro-optical dual-

polarization in-phase and quadrature modulator (DP-IQ modulator). If the OMFT is equipped with an optional internal laser source, this source can be used to generate an optical carrier.

3.2.1 RF DRIVERS

The unit features 4 differential RF inputs which are electrically amplified by internal RF amplifiers. Each amplifier channel can be individually optimized for RF gain and peaking. Peaking elevates the amplification at higher frequencies to achieve an overall flat frequency response since other components such as cables tend to exhibit a response that falls with frequency. Please refer to the inspection report of the unit at hand for details on the frequency transfer curves.

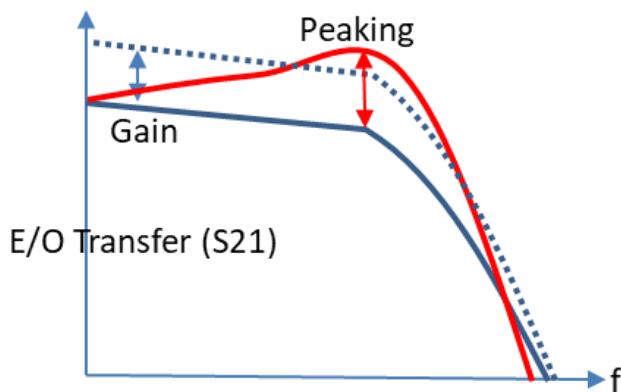

3.3 AUTOMATIC BIAS CONTROL

For turn-key operation of the OMFT, the modulator bias voltages are automatically controlled by an internal bias control device that sets and maintains the Optical IQ Modulator in an optimal operating point.

3.4 GENERAL

The instrument is operated via the local touch panel and an installation free Web interface operating in Web Browsers. Alternatively, a SCPI style command set can be used to operate the unit using a terminal window or third-party software.

The bandwidth and skew of the OMFT are characterized and provided to the user as calibration data. Hence, the user can fine compensate for the electrical skew and the bandwidths of the four electrical paths in case an arbitrary waveform generator (AWG) is used as a signal source by applying the corrections to the waveforms loaded in the AWG.

3.5 FRONT PANEL AND BACK PANEL VIEW

The front panel and back panel connectors are labelled and numbered as shown below. The following sections refer to this numbering.

3.5.1 FRONT PANEL

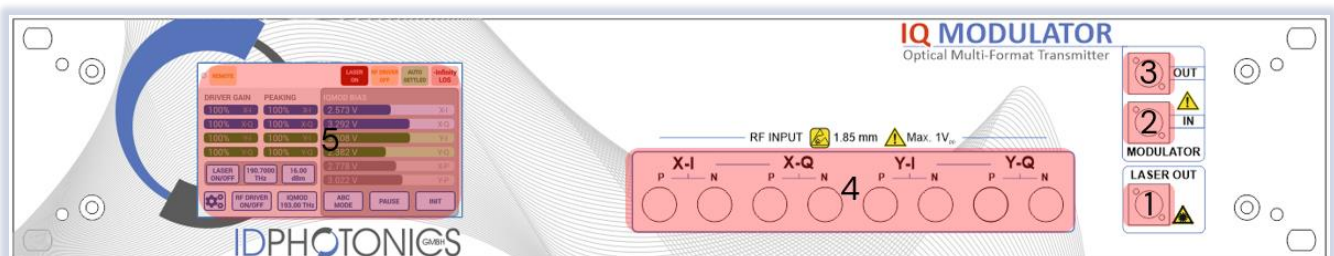

- (1) Optical laser output (optional) and status LED, indicating laser on/off state
Refer to inspection report for connector type installed in actual sample.
- (2) Optical modulator input
Refer to inspection report for connector type installed in actual sample.

- (3) Optical modulator output
Refer to inspection report for connector type installed in actual sample.
- (4) Electrical RF inputs
Refer to inspection report for present configuration in your sample.
- (5) Touch Panel
Local control and status information on the unit

3.5.2 BACK PANEL

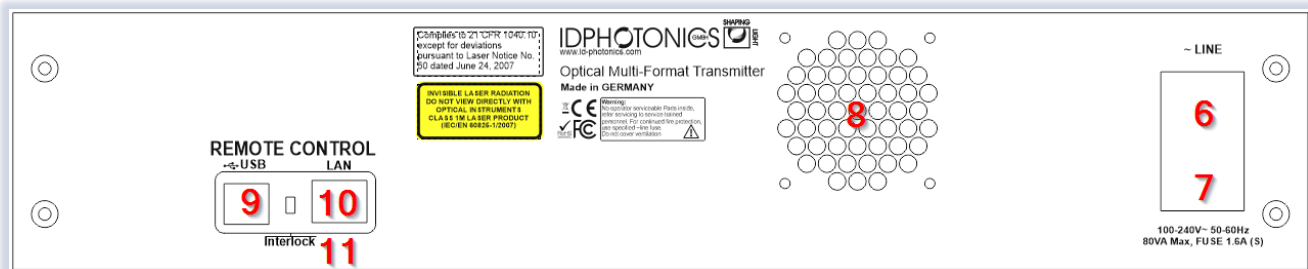

- (6) Power cord socket, On/off switch
100 to 240 V, 50 to 60 Hz
- (7) Main fuse compartment
one piece, 100 VA, 4A, slow
- (8) Fan outlets
do not cover!
- (9) USB port
USB-A female, for remote control
- (10) LAN port
RJ45, port for remote control
- (11) Interlock
Will disable Laser Output by Hardware for units with laser equipped

3.6 MACH ZEHNDER MODULATOR - THEORY OF OPERATION

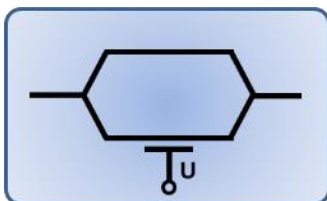

light.

Mach-Zehnder modulator structures are a popular way of modifying the intensity or phase of light waves that are based on a Mach Zehnder interferometric setup. The light is split, guided in 2 distinct paths and combined again to achieve interference. Utilizing materials with a strong electro optical effect allow changing the relative phase of the optical carrier waves that are converted into intensity changes by means of interference at the output achieving a modulation of the

The power transfer curve of a single MZM as a function of applied voltage is shown below.

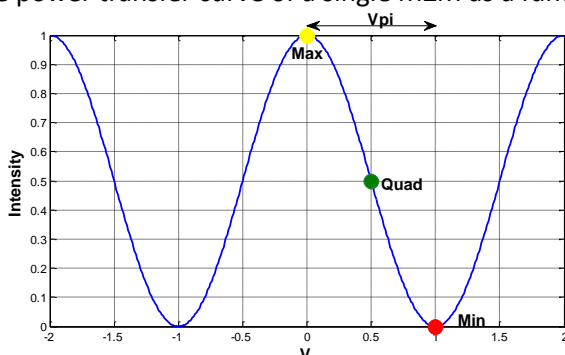

The Voltage change required to change the output power from maximum to minimum or vice versa is defined as V_{π} ($V\pi$). The mid-point between maximum and minimum transmission is defined as Quadrature (Quad). The unit at hand provides 2 nested Mach-Zehnder structures as depicted below. Each structure contains 2 inner Mach-Zehnders for I&Q modulation (XI, XQ for X Polarization and YI, YQ for Y Polarization) which are nested in an outer Mach-Zehnder structure that shifts the optical phase between the two inner Mach-Zehnders (XP and YP respectively).

The functional diagram below shows the configuration for the dual Pol IQ Modulator setup used in this instrument consisting of a Super MZM structure of 2 nested MZMs used for I and Q modulation. The incoming single polarization signal from a laser source is split into 2 parts and the polarization of 1 part is rotated orthogonally before routing them through 2 parallel of structures X and Y Polarization each handling 1 Polarization before routing them through 2 parallel of structures X and Y Polarization each handling 1 Polarization

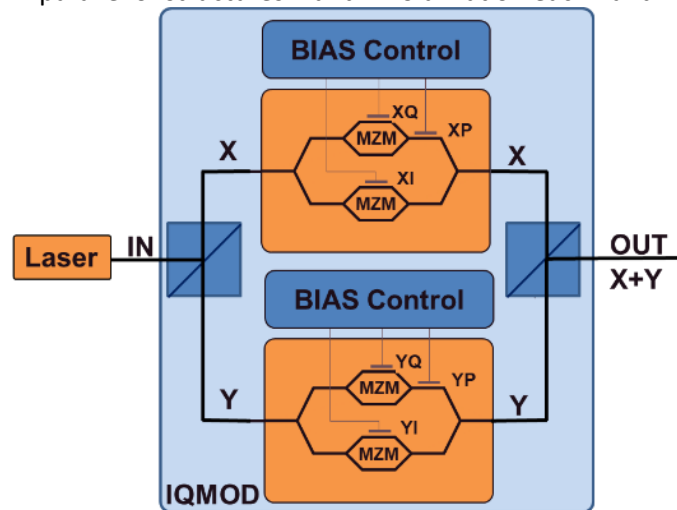

3.6.1 AUTOMATED BIAS CONTROL

The Automated BIAS Control feature of this unit is used to set the BIAS Voltage of Mach Zehnder Modulators (MZM) to its optimal operating point over carrier frequency, temperature and time by means of dither tones imposed onto the BIAS Electrodes and feedback signals generated from a photodiode monitor tap located after the MZM elements.

A key feature is the independence of the applied modulation format for IQ Modulator control supporting advanced modulation formats such as Nyquist shaped signals, QAM, SSB and pre-distorted signals. Furthermore, a BIAS optimization is possible without a RF signal present.

The control loop utilizes feedback signals derived from a feedback photodiode located after the MZM structure by means of dither tones that are applied to the BIAS electrodes of the MZM.

4 HARDWARE SETUP

This section describes the step-by-step procedure to connect the OMFT to external hardware and to put the OMFT device into operation.

4.1 GROUND THE INSTRUMENT

To ensure proper grounding of the OMFT device, connect the electrical power cord to the power cord socket (6).

NOTE

Do not turn-on the OMFT before the steps 4.2 to 4.6 are properly performed.

4.2 LAN OR USB CABLE FOR REMOTE CONTROL

The user can use both USB and Ethernet as interface for remote control of the OMFT with the provided GUI or using SCPI commands from self-built software.

4.2.1 ETHERNET CONNECTION

This section covers connectivity using Ethernet, skip it if you plan on using USB.

The default IP address is 192.168.0.1, DHCP off. If you plan to connect using the Ethernet interface, make sure the host PC is within the same subnet as the OMFT Ethernet Interface (The PC IP Address is 192.168.0.x then). The connectivity can be tested by opening a command shell (type “cmd” in windows search field and hit <enter>, a “black window with a DOS shell should open) and executing the command “ping 192.168.0.1”.

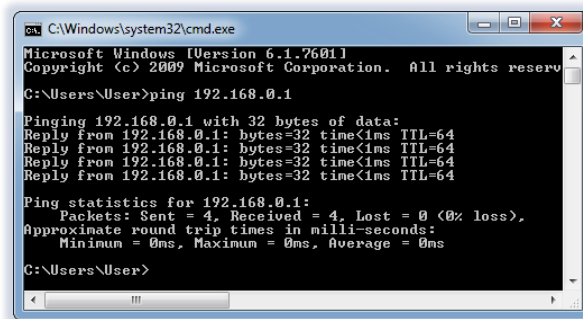

4.2.1.1 CHANGE OF IP SETTINGS WITH REMOTE ACCESS

If you do wish to change the IP settings and do not have remote access to the unit, use the local touch panel and press device Setup (Gear symbol). Then press “Network setup” and configure the interface accordingly. Alternatively, use the WebGUI or the SCPI interface to change the settings. Note that this change will require a reboot (soft reset of the unit) to become effective.

Note that changing the IP address requires the user to be connected with user level 1 or higher. Send the command “pass IDP” or enter the password “IDP” in the GUI to elevate the user level to 1.

4.2.2 OPENING A REMOTE CONNECTION VIA ETHERNET

The device supports a session based remote access on Port #2000.

Start the terminal program “putty.exe” supplied with the unit or use any other terminal program.

Set the following parameters in Putty and open the connection:

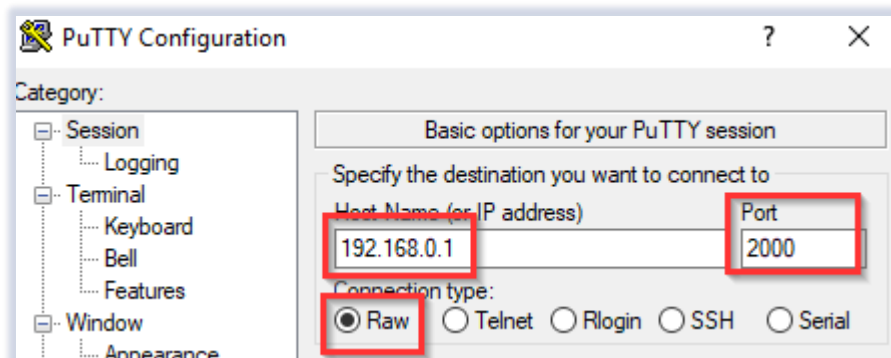

Alternatively to the default IP Address shown above, enter “omft.local” or the IP address currently set to the unit. If in doubt, use the touch panel display “Device config” – “IP config” to retrieve the actual IP Address.

Note that there must be a valid route on the IP layer between the device and the host PC (i. e. the ethernet port of the host PC is set to the same subnet as the device, for example 192.168.0.2) must be established before continuing. Use a command shell and command “ping omft.local” to test the route.

Once the connection is established, type in “*idn?” and hit <ENTER>. The unit responds with its *idn? String.

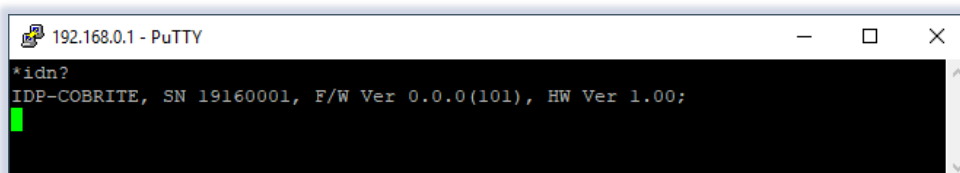

Alternatively, a request based remote control via http Port 80 is possible. To test this, open a browser window and type the following string into the address field:

http://omft.local/scpi/*idn?

For more details, see section 7.2 and section 4.2.

4.2.3 USB CONNECTION

This section covers connectivity using USB, skip it if you plan using Ethernet.

Once the unit is powered up and the USB cable is connected to the host computer for the first time, a new device installation should be triggered automatically within Windows.

Once installation is complete, three devices are installed on the host computer:

1. Virtual Ethernet Interface
2. Virtual COM Port
3. Virtual Storage device that contains resources such as manual and programming devices as well as drivers for Windows 7. It also contains the S2P Files as well as the inspection report of the unit.

4.2.3.1 WINDOWS 10

Windows 10 will automatically install 3 devices allowing to connect the unit

1. A virtual Ethernet interface (RNDIS)
2. A generic virtual COM port driver "Serial USB device". If you have several COM ports installed in the host PC, you may want to note the COM Port number under which the unit got installed. For further details on USB connection, see section 4.2.3.3.
3. A storage device similar to an USB Stick containing resources for the laser unit

The virtual COM Port and the virtual Ethernet interface are concurrent ways to access the unit for remote control. The web-based control is automatically accessed via entering "omft.local" or 192.168.0.1 (if default is set) into your browser.

4.2.3.2 WINDOWS 7

Windows 7 will install the same structure as described in the windows 10 section above. It will automatically install a virtual Ethernet interface (RNDIS) and the USB storage device ("Linux File- Store Gadget USB Device"). However, it does not have a preconfigured driver setup for the virtual COM Port. It will try to locate a driver for the unit on the host PC first and then check online. Stop the search and select the option "Install a custom driver". Point the installation routine to the driver located on the USB storage device provided by the unit in directory "USBDriverWin7" and select file "OMFTUSBSerialDriverWindows7.inf" in this folder. If the installation has been completed already, open Windows Device Manager, locate "CDC Serial", right click on it and select "Update driver". Proceed as described before.

Continue with the installation routine. Once installed, the virtual COM port should appear in Windows Device Manager as shown below. The COM Port number will be different for your system. Note down the number for later usage in remote control applications.

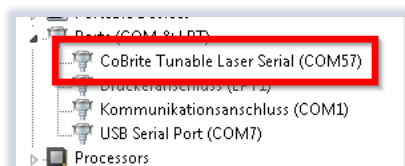

4.2.3.3 CONNECTION TO THE DEVICE VIA USB VIA HOST PC

Once installed properly, the USB connection provides a virtual COM Port and a virtual Ethernet Port to the instrument. To access the unit via virtual Ethernet, follow the instructions as in section 4.2.2 but note that the IP Address of the unit will be different as for the physical Ethernet Port.

To access to the unit using the virtual COM port, open a terminal window using the installed COM port number per description above.

4.3 INSTALLATION OF CONTROL SOFTWARE

This instrument does not require any installation of software for operation. Once connected to a host PC or a local network, simply enter “omft.local” into the address field of your Web browser to access the unit. For more details, see section 7.2 and section 4.2.

4.4 LASER OUTPUT (OPTIONAL, DEPENDING ON DEVICE CONFIGURATION)

Before connecting or disconnecting the optical fibers to the OMFT, it is strongly recommended to turn-off the laser sources any time! Never directly expose yourself or others to laser radiation! Permanent eye damage may occur!

The laser output port (1) is an optional feature to the OMFT unit. The internal laser source provides a narrow line width tunable source suitable for coherent transmission. A virtual red status LED in the touch panel GUI indicates the laser on/off state.

In case an internal laser is installed, the laser output (1) may be connected to the optical modulator input (2) using the supplied blue PM jumper patch cord. Use the local touch panel or remote control to enable and configure the laser (refer to Section 0 for further instructions).

4.5 OPTICAL MODULATOR INPUT AND OPTICAL MODULATOR OUTPUT

Before connecting or disconnecting the optical fibers to the OMFT, it is strongly recommended to turn-off the laser sources any time! Never directly expose yourself or others to laser radiation! Permanent eye damage may occur!

Connect a laser source (or sources) to the optical modulator input of the OMFT (2) using the appropriate connector cable. Refer to inspection report for connector type installed in actual sample. The laser source can either be the optional internal laser, if it is installed, or an external laser source. If the optical modulator input of the OMFT is PM, ensure that the laser source (or sources) has PM outputs.

Connect the optical modulator output of the OMFT (3) to the user’s measurement equipment, e.g. a coherent receiver, using an appropriate connector cable. Refer to inspection report for connector type installed in actual sample.

NOTE

Clean the fiber connectors each time they are connected to the OMFT device. Dirty connectors will increase the optical losses and/or possibly damage the connector! Dirt or pollution may also lead to damage of the fiber facets inside the OMFT.

NOTE

Do not turn-on any laser source(s) connected to the optical modulator input of the OMFT, before the OMFT is started. Start-up of the OMFT device resets the bias values to default values, resulting in fast changes of the modulator output signal intensity or loss of the modulator output signal. These fast changes in combination with optical amplifiers such as EDFAs (Erbium-doped fiber amplifiers) might cause optical transients or surges which can damage any equipment connected to the optical modulator output of the OMFT.

NOTE

Never exceed the absolute maximum ratings for the optical modulator input power (refer to section 0).

4.6 CONNECT THE RF INPUTS

NOTE

Avoid any electrostatic discharge, which may harm the RF devices inside!

Turn-off the electrical RF-amplifiers (RF Driver indicator in Touch panel must be OFF) as well as any signal source's electrical outputs connected to the OMFT, each time the cables are connected or disconnected.

Connect the electrical signal source (e. g. bit pattern generator or arbitrary waveform generator) to the electrical inputs of the OMFT device (4) by means of high-quality electrical cables (i. e. high bandwidth, high phase stability) mechanically matching the electrical input connectors of the OMFT. Refer to inspection report for connector type installed in actual sample.

The user should ensure properly de-skewed electrical signals at the OMFT input plane. The remaining skew of the electrical paths inside the OMFT can be compensated either by software in combination with an arbitrary waveform generator or by mechanical phase shifters (see Appendix 8.2.3 De-skewing of RF Drive).

The output of the electrical signal source providing the electrical input signals to the OMFT can be turn-on after connection of the cables.

NOTE

Never exceed the specified maximum electrical peak-to-peak amplitude to the OMFT (refer to section 0).

It is recommended to use a torque wrench with defined torque (e. g. 0.90 Nm for 1.85mm type - connectors) to tighten the nuts of the cable and connectors. Excessive torque will damage the cable and/or the connectors on the unit!

The unit utilizes differential RF inputs for optimum performance. However, the unit can be operated in single-ended configuration as well. In this case, terminate the unused input with proper 50Ohm terminators.

4.7 SWITCH ON THE OMFT DEVICE

After steps 4.1 to 4.6 are performed, the OMFT can be started by pressing the main power-on switch located at the rear panel of the unit. Wait for approximately 1 minute until the OMFT device has booted and ready which is indicated on the touch panel display.

Now, the external optical signal sources or the internal laser (optional) connected to the optical modulator input of the OMFT can be switched on.

NOTE

Make sure that the total optical input power level to the OMFT does not exceed the specifications given in section 0 and that no fiber connector is open or dirty.

Start-up of the OMFT device resets the bias values to default values, resulting in fast changes of the optical modulator output signal intensity or loss of the optical modulator output signal. These fast changes in combination with optical amplifiers such as EDFAs (Erbium-doped fiber amplifiers) might cause optical transients or surges which can damage any equipment connected to the optical output path of the OMFT.

NOTE

Turn-off any optical amplifier subsequent to the OMFT in case

- The electrical signal source is turned on or off
- The electrical signals to the OMFT are changed
- The optical input signals are changed or turned on/off
- Or the bias controller is reset or bias values are restored

5 TUNABLE LASER OPTION

This section only applies to units with a built-in tunable Laser source.

The integrated tunable Laser provides a grid-less step tuning mode (Coarse tuning) with a feature to detune the frequency set by Coarse tuning with higher resolution (Fine tuning).

5.1 LASER TUNING MODES

Coarse tuning allows accessing the full specified tuning range while fine tuning (FTF) allows for offsetting from the coarse tuning set point by a small range. The resulting set point is the sum of coarse tuning set point and FTF/fine tuning value.

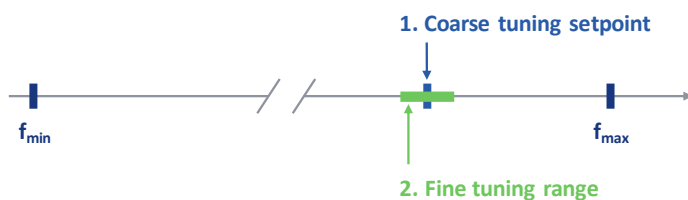

5.2 COARSE TUNING

This tuning mode allows tuning the laser to any frequency of the available range specified for the laser port. The tuning process will require the laser output to be disabled for a short period of time.

Description of tuning process:

1. Laser output will be switched off (~1 second)
2. Laser output is switched on using new frequency
3. Power is increased until final laser output power is reached. Maximum tuning time for this step is 15seconds
4. Power is stabilized, tuning process is completed.

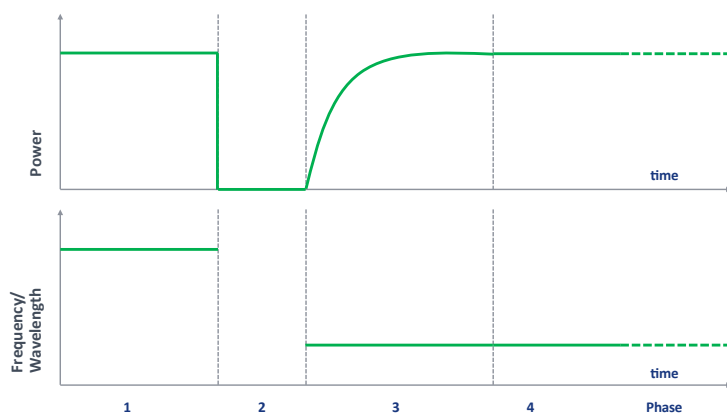

5.3 FINE TUNING (FTF)

Fine tuning allows detuning the laser within a small range of a few GHz from the target frequency that was set using the coarse tuning parameter. The laser will detune to the target setting with laser output power on during the tuning process which changes the output frequency in a linear ramp. Tuning target setting resolution is 1MHz.

1. Tuning is triggered
2. Tuning process is executed with a rate of ~ 0.11 GHz per second. During the process, the Laser output power remains constant.
3. Laser settles on new value

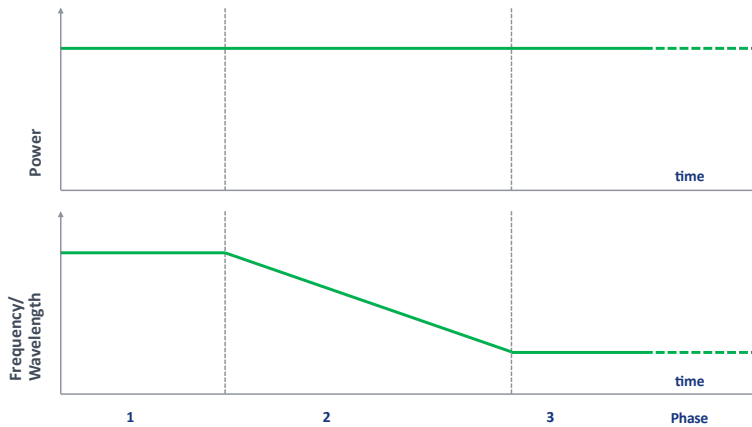

6 SOFTWARE

6.1 LOCAL TOUCH PANEL BASED USER INTERFACE (TOUCH GUI)

6.1.1 MAIN SCREEN

This Screen is partitioned into several areas controlling the building blocks of the unit (See also section - for details of the building blocks).

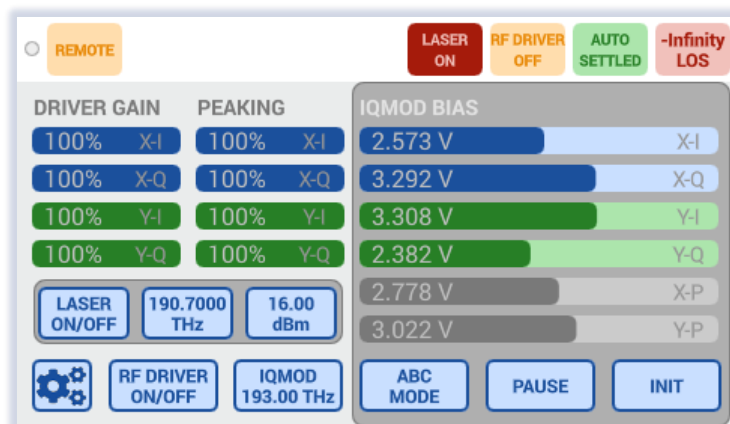

- The **top bar** is used for indicators that inform about the status of the unit
 - Green/grey dot: The dot is slowly blinking to indicate the application is ready and polling data
 - Remote**: A remote session via Ethernet or USB is currently active
 - Alarm** (not displayed): If any Alarm is pending, the indicator is showing up. Tick the indicator to retrieve more detailed information on the alarm
 - Interlock** (not displayed): Indicates that the hardware safety interlock located at the rear of the unit is currently active. A built-in laser cannot be enabled if Interlock is active. The interlock jumper is located at the rear panel of the device.
 - Laser on/off/tuning** (units with internal laser): Indicates the output status of the built-in tunable laser.
 - RF Driver on/off** Indicates the output status of the RF Drivers for the IQ Mod Component.
 - BIAS Control Status** This indicates the status of the IQ MOD BIAS Control. It can assume the states: {Manual/Init/Auto/Auto Settled/ABC Paused}. See details in section 6.5).
 - Power Indicator** The optical output power of the unit is monitored by a tap Photodiode. The output power is indicated here. In case the signal power drops below the Loss of Signal Threshold

(LOS) the indicator color is turned to red and LOS is declared. This will halt the IQ MOD BIAS Control (Auto Pause).

2. **Driver Gain and Peaking** indicate the current setting of the RF channels and allows controlling the gain level and the spectral peaking setting by a touch on the corresponding bar. This will open up a pop up with a slider of which the setting is immediately transferred to the hardware.

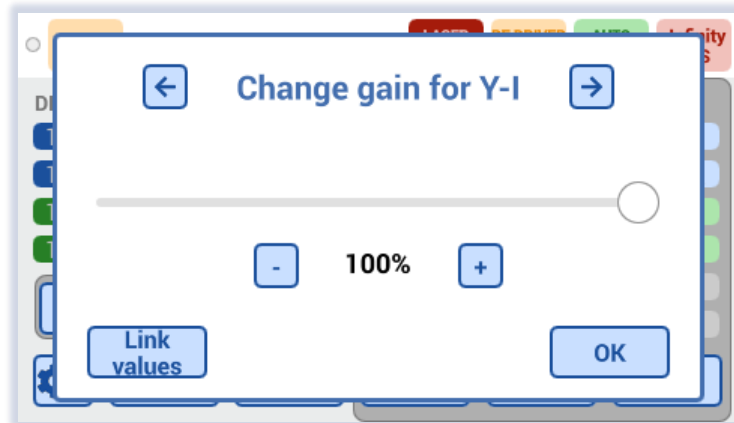

“Link Values” will apply the same setting of the current channel to all other channels. Click on the upper arrows to access the other channels. Press ok to close the pop up.

3. **Laser** (only on units with built-in laser): Press and hold the Laser on/off button to enable or disable the laser. The buttons indicate the status of the lasers and allow to change the setting by clicking on the buttons. This will open a popup that allow to change the laser settings. “Synch IQMOD” will set the same Frequency/Wavelength setting dialed in for the laser to the IQ Modulator. Changes will be applied when the ok button is pressed.

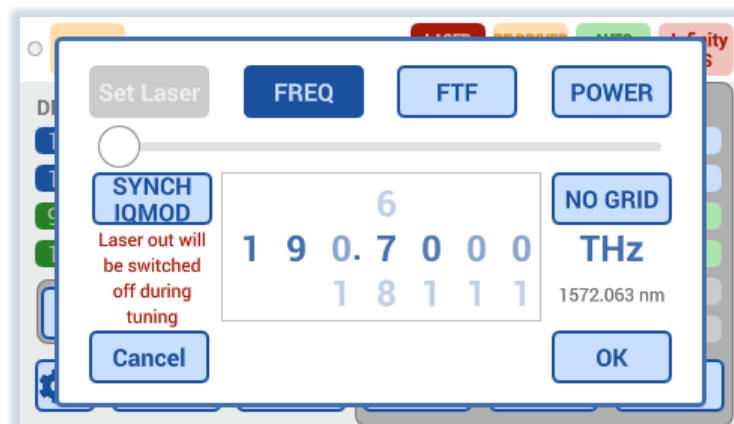

4. **RF Driver on/off** Press and hold the RF driver on/off button to enable or disable the RF channels. Make sure that the RF Inputs are properly connected before the RF Amplifiers are enabled. Note that there are optical transients may occur when the RF amplifiers are enabled and an RF Input signal is present. Make sure to protect the downstream setup like Photodiodes accordingly.
5. **IQMOD Frequency** indicates the current frequency setting of the IQMOD and allows controlling the setting by touching on it. Always set this value to the Carrier Frequency of the connected laser source to ensure optimal performance of the device.
6. **IQMOD BIAS** Indicates the current settings of the BIAS Voltages. See section for details 3.6. In Auto Mode, these values are automatically optimized. In Manual mode, the values can be changed by touching any of the bars. This will open up a pop up allowing to change the setting. This will be applied immediately upon input. Use the arrows to cycle to the next electrode. Press ok to close the pop up.

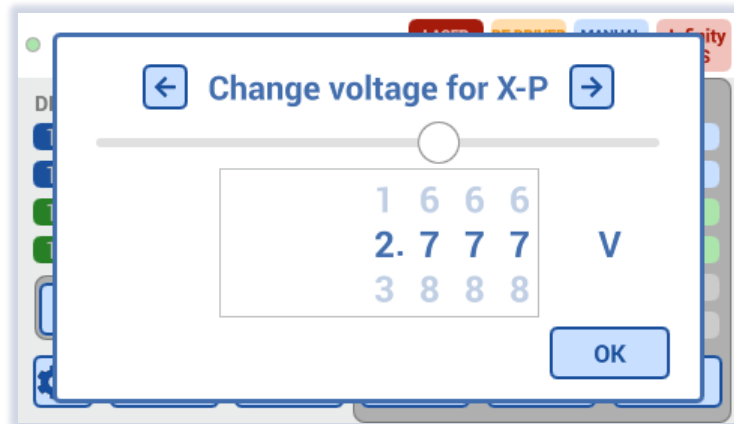

7. **ABC Mode** Press this button to toggle the Automatic BIAS Control (ABC) for the IQMOD between Auto Mode and Manual Mode. The current status is indicated in the status bar at the top. In Manual mode, the BIAS Values can be changed by the user. When switched from Manual to Auto, the settled status is cleared and reacquired. For short stops of the ABC, use the Pause/Mute mode instead.
8. **Pause** halts the ABC in the current setting. This can be used to take measurements without the interference of the working ABC. Toggle again to restart the ABC. In contrast to switching into manual mode, the ABC will immediately halt even if an active ABC cycle is performed and does not re-acquire the settled status when resumed.
9. **Init** Will Initialize the ABC to its startup status. Note that there are optical transients may occur when Init is performed. So, make sure to protect your setup like Photodiodes accordingly.
10. **Setup** (Gears) allows to show and change system settings of the unit. See next section for details.

6.1.2 SETUP SCREEN

Pressing the “Gear” button in main screen opens a popup to access the setting of the unit.



Frequency/Wavelength Mode allows toggling between system wide display of carrier wavelength or frequency.

Lock Out Remote will close current remote sessions to the device and reject future requests as long as this mode is active-

Device Info provides Device configuration, software and hardware version and serial number information

Network config provides access to the settings of the physical and virtual Ethernet interface of the unit. Touch the corresponding buttons to change the settings. Changes to the settings become effective only after a reboot of the unit.

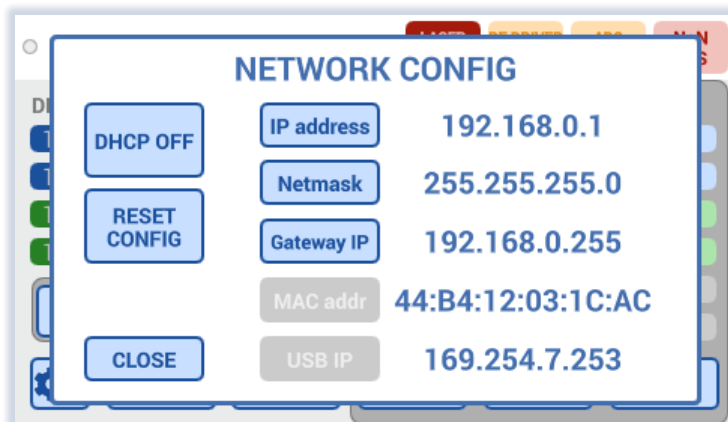

Restart unit will perform a soft reset of the unit.

Shutdown unit Will safely shut down the hardware and software of the unit. Always perform this step before switching off the unit using the main power switch.

6.2 WEB BASED GRAPHICAL USER INTERFACE (WEBGUI)

The WebGUI can be accessed from any host device such as a PC that is either on the same Ethernet Network as the OMFT unit or is connected via Ethernet and supports the USB virtual Ethernet structure (i.e. Windows 10 devices).

The WebGUI can be accessed by entering “omft.local” into the address field of the internet browser. The WebGUI was tested with Edge, Chrome and Firefox with current revisions at the time of testing.

6.3 WHAT IF “OMFT.LOCAL” CANNOT BE REACHED BY HOST COMPUTER?

Depending on the configuration of your host PC DNS structure, the <http://omft.local/> address might not be resolved into the correct IP address of the device.

In case the name resolution is not working in your network, open the device settings on the local touch panel to retrieve the IP address of the unit. Enter the IP address in the address field of the browser instead.

6.3.1 IP ADDRESS RETRIEVAL - LOCAL TOUCH GUI

Retrieve the IP Address in local Touch display under “Device Config – Network Config” and use it instead of the name.

Note that there are 2 IP addresses shown, one for the physical Ethernet interface (Network Interface) and one for the virtual Ethernet interface installed via USB.

6.3.2 ETHERNET METHOD

If the default IP address of the device was not altered, it is “192.168.0.1”. Configure the Ethernet address of the host PC to 192.168.0.2. Make sure to disable to disconnect other Ethernet interfaces on this PC to avoid potential interference. Connect the Ethernet cable to the host PC and the unit. LEDs next to the Ethernet should become green. Enter “192.168.0.1” into your Browser on the Host PC.

6.3.3 LABEL

There is a label showing the serial number and part number located at the back of the unit that has the default IP Address for both Ethernet IP and USB IP.

6.4 DESCRIPTION OF WEBGUI

The WebGUI was tested on Windows 7 and Windows 10 Computers using Edge, Chrome and Firefox and iPhone/iPad using Safari browser. Note that we cannot guarantee operation in any Browser environment in general.

The WebGUI functionality is very similar to the local touch interface. A short overview is given here. For details, see the local Touch WebGUI description.

6.4.1 STATUS BAR

The upper status bar is, independent of the tab, always visible. It displays the status of the main building blocks of the unit: - tunable laser, RF drive, ABC and Output power Monitor. On the right-hand side, “File” contains a drop-down menu where resources stored in the unit can be downloaded:

- Windows 7 driver for USB Port
- Remote Control Examples for Matlab, Python and LabView
- Manual
- S2P S-Parameter calibration files for the unit
- Inspection Report of the unit

The same content is accessible via an automatic Mass storage mount (“USB Stick”) when connected via USB Port.

6.4.2 RF DRIVER/IQMOD TAB

This tab allows accessing most of the device features for daily usage.

The top bar provides the same indicators as already described in the local touch WEBGUI section.

Click on the “Files” button will open a list of resources stored in the unit that can be downloaded from here. This also includes the S Parameter Characterization files (not shown in screen shot).

To access the driver gain, peaking or IQMOD BIAS settings, click on the corresponding bars.

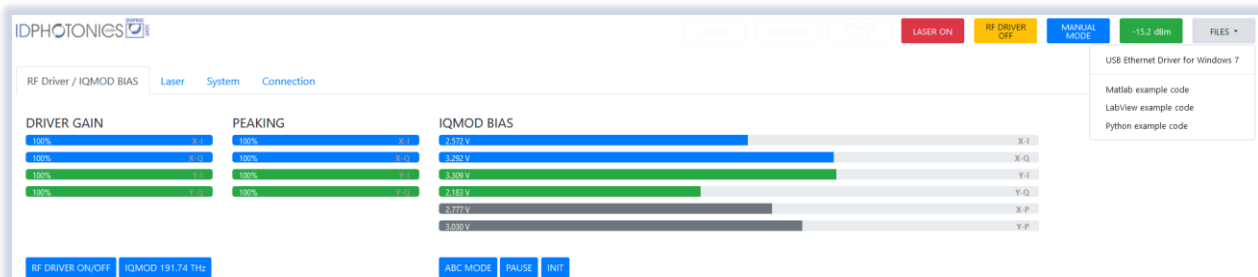

6.4.3 LASER TAB

The laser tab is only displayed for units hosting an internal laser source. Click the parameters to enter new values which are applied upon clicking “ok” or pressing <enter> on a keyboard. Each setting is applied separately.

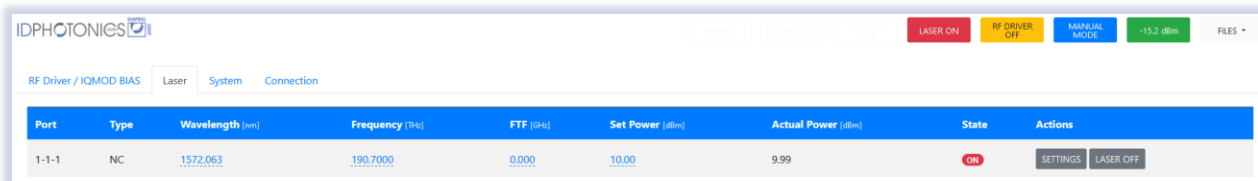

The “Settings” button opens a popup allowing to change all parameters at once and allows to sync the IQMOD Calibration carrier frequency to the current setting of the laser.

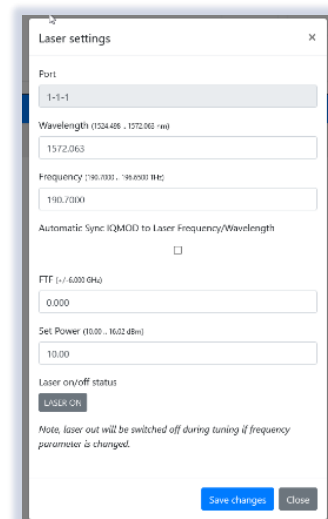

6.4.4 SYSTEM TAB

This tab provides details about Alarms present, allows to clear past latched alarms and send SCPI commands. See section 0 for details.

Identify unit inhibits a blinking indicator on the local touch GUI that is controlled by the WebGUI. This allows identification of the actual unit in case multiple OMFT devices are located in the same network.

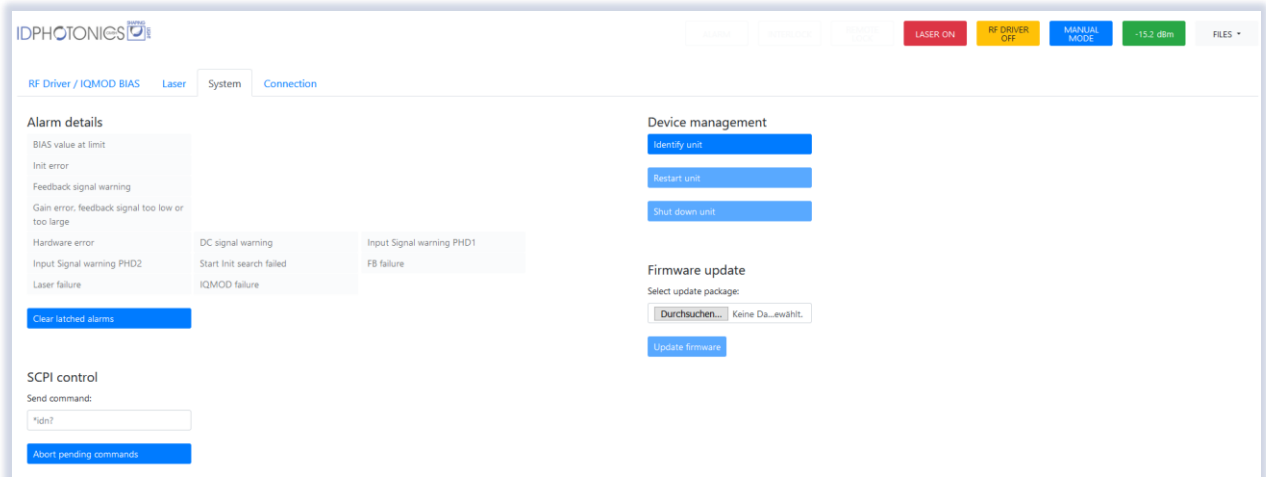

The following buttons are greyed by default as they require a password to be sent first in tab “Connection” and require user level 1 at least, see next section for details.

- **Restart unit** and **Shutdown unit** will perform the actions already described in the local touch GUI section.

- In case a new firmware file (format *.zip) is provided by ID Photonics, first click on “browse” to select the corresponding file and then press “**Update Firmware** “. The firmware is then uploaded. The process is indicated by a corresponding

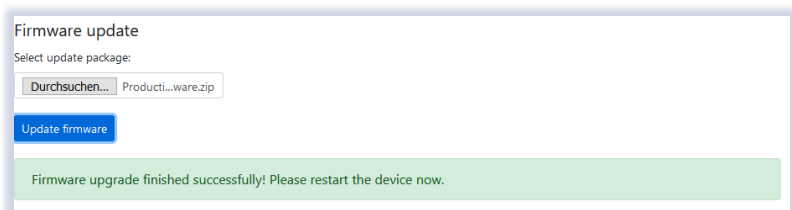

message. Upon completion, a message is displayed. Press **Restart unit** to trigger the update process. The unit will then perform a reboot. After reboot, perform a “reload” in your browser window to reset the WebGUI. The firmware version can be checked under tab Connection.

6.4.5 CONNECTION TAB

This tab gives access to the interface parameters of the device as well as device info such as firmware revision, serial number etc.

It also allows changing the Network settings of the Ethernet interface. Login with user level 1 by entering a password to allow changes on the settings.

The “download service logs” button will trigger collection of status information of the unit for which a download is automatically starting after a few seconds.

Use the field User level authentication to access features requiring a password. See section 0 for details.

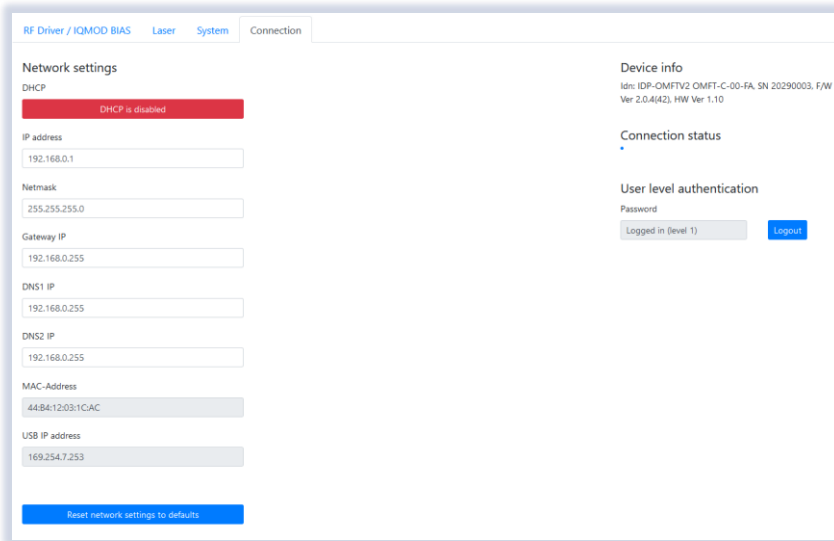

6.5 BIAS CONTROL LOOP STATE MACHINE

The automated BIAS control is based on a finite state machine model. It can assume the following states MANUAL, TRACKING, TRACKING_PAUSE, INIT, INIT_PAUSE and FAULT.

Please see below a state diagram including all possible state transition conditions.

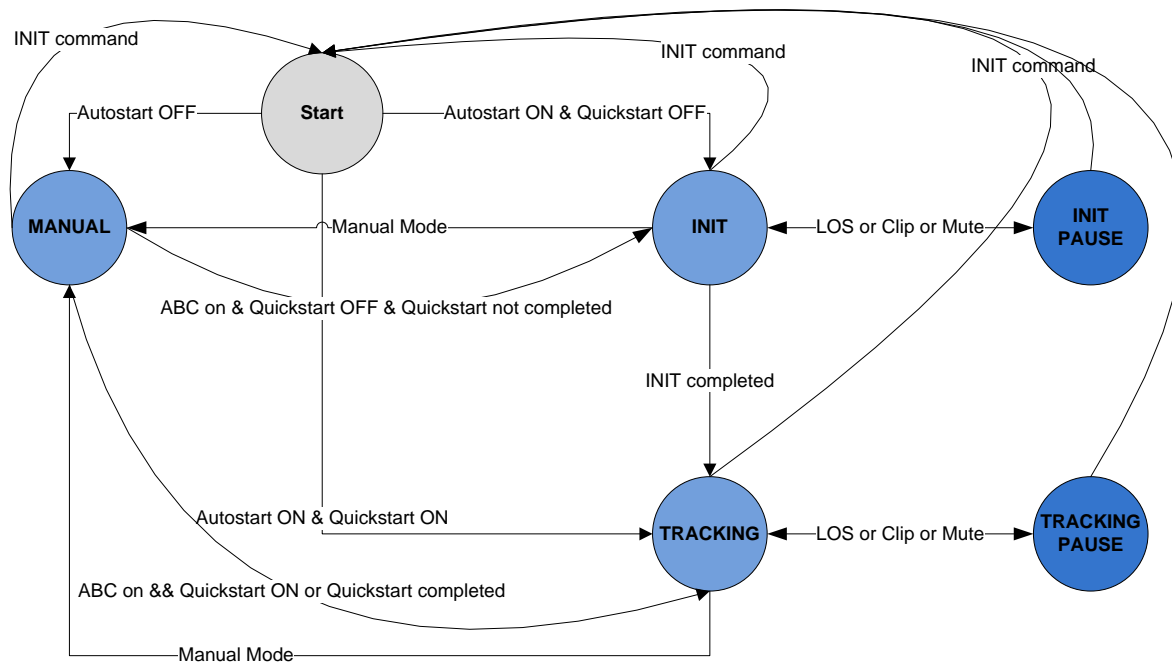

The automated BIAS control will find and track the optimal BIAS points in 3 phases:

1. INIT (if QuickStart is off): A coarse sweep of one or multiple BIAS electrodes is performed.
2. TRACKING (not settled): The control loop runs in an accelerated tracking mode to swiftly move close to the target setting.
3. TRACKING (settled): The control loop runs in a slower tracking mode to achieve best accuracy and performance.

In the GUI, the ABC states translate to the following description:

Init: Init

Manual: Manual

Tracking: Auto

Tracking settled: Auto settled

Tracking pause: Auto pause

7 REMOTE CONTROL

This device operates using SCPI standard style commands which are ASCII based and allow easy communication and interpretation with the instrument. Refer to chapter “Board and Connector description” on how to establish communication to the ports available at the instrument. More detailed information on SCPI syntax can be found here:

<http://www.ivifoundation.org/docs/SCPI-99.PDF>

7.1 OPERATING MULTIPLE INTERFACE PORTS

This unit supports parallel usage of all remote-control ports available. Note that responses to commands issued are only returned to the according interface from where the command was issued.

Commands are generally executed in order of time wise arrival to the controller and buffered into an Event queue. If a stack overflow occurs, an error is issued.

Note that there is no control exclusivity for a specific interface or user. Thus, parallel commands issued by different instances will be might lead to inconsistencies. It is therefore recommended to poll current parameter status to ensure integrity of set vs. actual parameters and query the operation complete register (“*opc?”) to make sure all previous commands have been executed.

7.2 CONNECTION TYPES

There are 2 types of connections that can be used to remote control the unit via SCPI:

1. Connections made with the device can be session based by a raw terminal connection (see 4.2.2) using Port 2000 for Ethernet or a COM Port session (4.2.3.3).
2. Connections through HTTP Service (Port 80). In this case, the SCPI command is encapsulated in the following http request:

`http://<OMFT IP>/scpi/<SCPI-Command>`

A typical example is: `http://omft.local/scpi/*idn?` Which queries the identification string of the unit.

The ASCII encoded response is identical to the session-based response.

<wsp> characters defined in the SCPI definitions are to be replaced with ASCII string “%20”. No termination character “;” or <CR> is needed for HTTP based access.

7.3 SYNTAX CONVENTIONS FOR COMMANDS

7.3.1 LONG AND SHORT FORM

The key words feature a long form and a short form. Either the short form or the long form can be entered in one command, other abbreviations are not permissible.

Example: “:SYStem:IPADDRess?” is equal to “IPADDR?”

NOTE

The short form is marked by upper-case letters; the long form corresponds to the full expression. Upper-case and lower-case notation only serve the above purpose, the instrument itself accept both upper-case and lowercase letters.

NOTE

All commands are case insensitive. Long and short form may not be mixed within a single command.

7.3.2 QUERY COMMANDS

Most commands serve a double function that allows either setting or executing a query on a parameter.

NOTE

Query commands are terminated by a “?” character.

7.3.3 PARAMETER

Parameters must be separated from the header by a “white space”. If several parameters are specified in a command they are separated by a comma “,”.

7.3.4 COLON CHARACTER

A leading colon character “:” instructs the instrument to interpret the command starting at the root (highest level) of the command tree. Since the Instrument also starts at the root each time you send it a new command, the leading colon is not required (although the instrument will accept it if you send it).

7.3.5 COMMAND TERMINATION CHARACTER

Each command must be terminated either by a “;” character or a carriage return (ASCII #13) to signal completion of the command telegram to the controller.

! NOTE

Sending two termination characters is a common mistake causing the unit to respond with “ERR 100;” since the first command is executed once the first termination character is received and the second termination character causes the unit to interpret an empty command. Example:

Command: “volt 1,2;<CR>”

Response “;<CR>ERR 100, unknown command;”

The unit will set BIAS voltage 1 to 2V but additionally receives the empty command which causes the error response.

7.3.6 ACKNOWLEDGEMENT OF EXECUTED COMMANDS

The mainframe controller will always acknowledge successful execution of commands by a “;” character. If the echo option is set (for details, see command list), the accordingly sent command is returned first.

7.3.7 COMMUNICATION EXAMPLE

Host sends: *idn?;

unit response: IDP-OMFTV2 OMFT-C-00-FA, SN 19160001, F/W Ver 1.0.0(101), HW Ver 1.00;

7.3.8 BASIC SCRIPT EXAMPLE

The following commands can be a minimal script to perform a basic set up of the unit and read the data

COMMAND	COMMENT
INTI;	Initialize Communication settings
*IDN?;	Query idn string of unit
PASS IDP;	Raise user level to 1
*opc?;	Queries if command has been executed (status 1)

Screenshot of script example result:

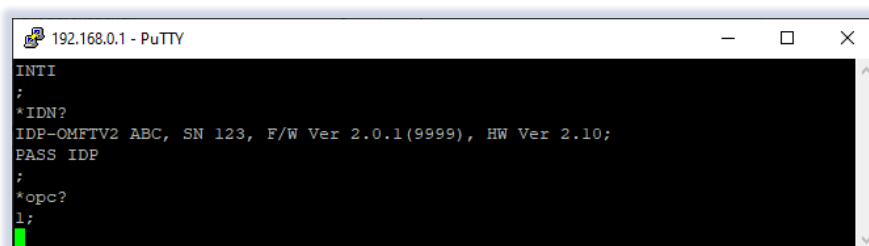

```

192.168.0.1 - PuTTY
INTI
;
*IDN?
IDP-OMFTV2 ABC, SN 123, F/W Ver 2.0.1(9999), HW Ver 2.10;
PASS IDP
;
*opc?
;
1;
;

```

<ENTER> was used to execute the command. Alternatively, use “;”. If both is used, it is interpreted as 2 commands of which the second one is empty so that the first command is executed but the second produces an error since empty.



```

192.168.0.1 - PuTTY
*OPC?
l;
*OPC?;
l;
ERR 100, unknown command;

```

7.4 USER ACCESS LEVEL

This feature allows execution of commands protected in standard access level to avoid accidental change of important parameters or reboot and shutdown of the unit. See command description

“[:SYStem:]PASSwOrd“ for details on how to enable enhanced access.

Custom passwords can be set to the unit for enhanced security requirements. See details in description for “[:SYStem:]SetPASS<wsp>,<P>,<P>”.

Note: User access level is granted session based. Each time, a new remote connection is made; the standard User access level 0 is set per default.

USER ACCESS LEVEL	PASSWORD
0	-
1	IDP

7.5 NOTATION OF SYNTAX FOR COMMAND DEFINITION

SYNTAX AND TYPE	DESCRIPTION
[]	Optional command level that can be omitted. Example: Definition [:SYStem:]IPADDRess/? /<P> Allows sending the command: IDADDR?
< >	Denotes a parameter. Placeholder is replaced with parameter value defined for according command. Definition [:SYStem:]IPADDRess/? /<P> Allows setting the parameters: [:SYStem:]IPADDRess 192.168.0.1
/?	Denotes the optional character “?” that is used if the command can also be used as a query. Example: Definition [:SYStem:]IPADDRess/? /<P> “?” is used to query current IP Address of the device: IPADDR?;
:	Usage of Colon see 7.3.4
<wsp>	Denominates a white space character
<INT>	Integer value
<REAL>	Real value

7.5.1

7.5.2 CONVENTIONS FOR WRITING TO MULTI-CHANNEL OUTPUTS

For read queries issued to a Multi-Channel output such as the BIAS Electrodes, the interpreter will return the current setting of all channels available, i.e.:

Query `VOLT?`;

Response: `2.34, -5, 6.98, 3.1, 9.99, 12.93;`

For Write Commands, each channel must be set separately by a command. The following example sets the BIAS Voltage for channel 2 to 5.67V:

Command `VOLT 2, 5.67`

Response: `;`

7.6 GENERAL SCPI COMMANDS

SYNTAX	EXAMPLE READ	DESCRIPTION
<code>*idn?</code>	<code>*idn?;</code> IDP-OMFTV2 OMFT-C-00-FA, SN 19160001, F/W Ver 1.0.0(101), HW Ver 1.00	Query System Type and Software version
<code>*opc</code>	<code>*opc;</code> <code>1;"</code>	Query all pending commands executed
<code>*rst</code>	<code>*rst;</code> <code>;</code>	Reset Controller; will cold start the instrument. All connections/sessions will be closed. Requires user level 1
<code>*WAIt</code>	<code>*WAI;</code> <code>;</code>	Unit waits with response until <code>*opc?</code> is 1. Eliminates need for polling loop of <code>*opc?</code> on remote side
<code>*CLs</code>	<code>*CLS;</code> <code>;</code>	Clears all status/alarm registers of the unit. This command is used to clear latched alarm registers.

7.7 COMMANDS ON SYSTEM LEVEL

SYNTAX	READ WRITE	USER ACCESS LEVEL	PARAMETER FORMAT	DESCRIPTION
<code>[:SYStem:] ECHO/?/ <wsp><P></code>	RW	0	"0" or "1"	Sets or query echo command sent status, this setting applies to current session only
<code>[:SYStem:] DEFAULT</code>	W		-	Resets user settings such as laser settings to factory default. This affects all settings including trigger configuration except Remote interface settings.
<code>[:SYStem:] STArtDEFa ult /?<wsp>/<P></code>	RW	1	"0" or "1"	Queries/Sets of unit starts with last settings set before a reboot or with default of device. This affects all settings except Remote interface settings and Laser Port on/off status. 0 = Save each change of setting and restart with current config upon next reboot

SYNTAX	READ WRITE	USER ACCESS LEVEL	PARAMETER FORMAT	DESCRIPTION
				1 = Always start with unit factory defaults
[:SYStem:]ENABLeAUTOSTArt/?<wsp>/<P>	RW	1	"0" or "1"	Enables or disables if laser port on/off status is saved and executed upon reboot.
[:SYStem:]INFORMatiOn?	R	0	IDP-OMFTV2 OMFT-C-00-FA, SN 19160001, F/W Ver 1.0.0(101), HW Ver 1.00	see *idn? For detailed description
[:SYStem:]DHCP/?/<wsp><P>	RW	1	"off" or "on"	configure DHCP Setting for Ethernet interface
[:SYStem:]IPADDRESS/?/<wsp><P>	RW	1	xxx.xxx.xxx.xxx	IP Address Setting of Ethernet interface
[:SYStem:]NETMASK/?/<wsp><P>	RW	1	xxx.xxx.xxx.xxx	Netmask Setting of Ethernet interface
[:SYStem:]GATEWAYIP/?/<wsp><P>	RW	1	xxx.xxx.xxx.xxx	IP address for Gateway of Ethernet interface
[:SYStem:]USBIPADDRESS?	R	0	xxx.xxx.xxx.xxx	IP Address Setting of virtual Ethernet interface on USB
[:SYStem:]USBNETMASK?	R	0	xxx.xxx.xxx.xxx	Netmask Setting of virtual Ethernet interface on USB
[:SYStem:]MACADDRESS?	R	0	XX:XX:XX:XX:XX:XX	Reads MAC Address of unit
[:SYStem:]IPConfigDEFault	W	1	-	Resets all settings of remote interfaces to factory defaults. This becomes effective only after a reboot of the unit.
[:SYStem:]INTERfaceInit	W	0	-	Reset session parameters to defaults. Call this after opening the remote port. This commands resets ECHO, PASS, FORMAT, UNIT:X, LINLOG, EVENT.
[:SYStem:]REMOte?	R	0	"0" or "1"	Query remote status of device. Any open remote sessions via Ethernet?
[:SYStem:]PASSword/?/<wsp><P>	RW	0	ASCII	Set new User level status by sending password or query current User level status
[:SYStem:]TIME?/<wsp><P>	R/(W)	0	xxxxxxxx	Query or set system time. Note that time is set and tracked in volatile memory only. It requires to be set after each cold start.

SYNTAX	READ WRITE	USER ACCESS LEVEL	PARAMETER FORMAT	DESCRIPTION
[:SYSTem:]ALARm?	R	0	xxxxx	Query alarm status of device, see Alarm code definition for details
[:SYSTem:]STATus?	R	0	"INIT"; "FAULT"; "READY"; "OVERLOAD"	Query current state of OSA; see Alarm state for match
[:SYSTem:]ERRor[:NEXT]?	R		-	Queries data in an error queue and deletes it from the queue.
[:SYSTem:COMMunicate:]LOCKout/?	RW	1	"0" or "1"	Locks other sessions to perform write commands on the unit. It is automatically released if the active session closes
[:SYSTem:COMMunicate:]ParameterREFresh?	R	0	<INT>	This query allows detecting if any change to the configuration was done. Each time the counter increases, the configuration was changed. This is useful in multi-user environments to detect if a parallel session has changed settings on the unit
[:SYSTem:]IPConfCHanged?	R	0	0 1	Check if IP configuration of the Ethernet Interface was changed but no reboot was triggered yet to activate the new settings. This can be used to determine if the actual settings differ from the settings that will be active upon restart.
[:STATus:OPERation:]EVENT?	R	0	-	Read status of instrument if scan has been completed (1) or not (0). Each read of "EVENT?" will clear the status for each remote session separately. This can be used to query if previous scan has been completed.
[:]ABORT	W	0	-	Aborts all currently executed pending commands as fast as possible. Query *OPC? To determine status once all pending commands are aborted
[:SYSTem:]IDENTify<wsp><P>	W	0	"0" or "1"	En- or disables blinking of the on the unit allowing identification of the unit attached to remote control.
[:SYSTem:]LAYout?	R	0	-	Query chassis configuration. The response returns the chassis type (CBDX1, CBDX, CBMX) and lists the installed slots and corresponding number of lasers.

SYNTAX	READ WRITE	USER ACCESS LEVEL	PARAMETER FORMAT	DESCRIPTION
				Example: lay? Response: CBDX, 1, 1, TLS1;
[:SYStem:]INTLock?	R	0	"0" or "1"	Query the status of the interlock setting. Optical output of lasers can only be enabled if the interlock jumper located at the rear panel is set.
:SYStem:RESet	W	1	-	Will reset instrument. Same as command *rst, see details in description of *rst
[:SYStem:]SetPASS<wsp>, <P>, <P>	W	-	-	Sets a password to access the defined user level. Requires current user level to be at or higher for level that password is to be set. First parameter is user level for which password is set, second is a string defining the password.
[:SYStem:]CStAtus?	R	0	"TRACKING", "TRACKING_PAUSE", "INIT", "INIT_PAUSE", "MANUAL", "FAULT"	Query current state of BIAS Control
[:SYStem:]SHUTDown	W	1	-	The unit operates on a LINUX System. Shut down the unit before power off using this command to avoid data loss.

7.8 BIAS CONTROL COMMANDS

7.8.1 COMMAND DESCRIPTION

COMMAND	PARAMETER OPTIONS	DESCRIPTION
[:BIAS:]AUtoStArt/?/ <wsp><P>	"0" or "1"	0: Bias Control will remain in Manual mode after startup 1: Bias Control will automatically run INIT and continue in TRACKING state
[:BIAS:]QuicKStArt/?/ <wsp><P>	"0" or "1"	Skips INIT state after startup. This option is only recommended
[:BIAS:]FActoryDEfault	-	Resets all parameters saved by SCSTAT back to Factory defaults.
[:SYStem:]SaveCurrStAtE	-	Saves current BIAS Voltages as new Init Settings.
[:BIAS:]SEtTled?	"0" or "1"	Indicates if Automatic BIAS Control is settled (only TRACKING mode)

COMMAND	PARAMETER OPTIONS	DESCRIPTION
[:BIAS:] INIT/?/ <wsp><P>	"0" or "1"	Write: Will trigger the initialization routine Read: Indicates whether control loop is currently in initialization phase. 1: Init active 0: No Init in progress
[:BIAS:] VOLTage/?/ <wsp><P>, /<P>	-	Write: Set BIAS Voltages. First Parameter is Channel ID, second is BIAS Voltage to be set to selected electrode. Set is only possible in manual mode. See according table for electrode type assignment. Example: VOLT 1, 5.365; Read: Query current BIAS voltages. Response will be all 6 BIAS Voltages without Channel ID. Example: VOLT?; 1.987, 5.365,8.487,6.456,11.567,15.734; See 7.5.1 for details on the parameter convention.
[:BIAS:] STATusVOLTage?	"0" or "1"	Query if any BIAS Voltage is 5% or less to maximum/minimum
[:BIAS:] CONTrol/?/ <wsp><P>	"0" or "1"	Query or set status of automated BIAS Control. 1: Control Active 0: Manual Mode Active
[:BIAS:] OPOWer?/ <wsp><P>	+/-x.xx	Query current optical output power in [dBm]. For ABC only: This value is only correct if power calibration was performed before. The optional parameter allows to read only 1 channel. i.e. OPOW? 1; reads the optical power of feedback channel 1
[:BIAS:] MUTE/?/ <wsp><P>	"0" or "1"	Query or set MUTE status. If MUTE is active, automated BIAS Control will not change any BIAS Voltage and switch to a low noise mode intended for delicate measurements. A query will also indicate the MUTE status that is set by the external H/W input. 1: Mute Active 0: Standard operation
[:BIAS:] LOSStatus? /<wsp><P>	"0" or "1"	"Query if output power of device is too low for automatic BIAS Control. 1: Loss of Signal (LOS) - Signal too low. Control loops stops 0: Signal within valid range" Note that this feature requires a valid power calibration of the feedback path. For OMFT, these values are calibrated at production.
[:SYSTEM:] LOSThresh/?/ <wsp>/<P>, /<P>	Ch, Power[dBm]	This sets the Loss of Signal (LOS) threshold of the unit. If the power at the feedback path drops below the specified value, the ABC stops tracking and a warning is issued. Note that this feature requires a valid power calibration of the

COMMAND	PARAMETER OPTIONS	DESCRIPTION
		feedback path. For OMFT, these values are calibrated at production.
[:BIAS:] INitPROGress?	xxx	Progress of Init Procedure reported in [%]
[BIAS:] TRackInLOS/? /<P>	"0" or "1"	If enabled(1), control loop is forced to continue operating even if LOS alarm is present. CAUTION: The control loop will drift away if no feedback signal is present (i.e. no light source connected).
[:BIAS:] FOFFset/? /<P>, /<P>	x,x.xxx	Write: Set Feedback Offset target. First Parameter is Channel ID, second is offset of Feedback signal to selected electrode. See according table for electrode type assignment. Read: Query current offset value. Response will be all 6 Feedback offsets without Channel ID. Example: FOFF?; 1.987, 5.365,8.487,6.456,11.567,15.734; See 7.5.1 for details on the parameter convention.
[:BIAS:] CHannelACTive/? /<wsp><P>, /<P>	1 to 6, "0" or "1"	Write: Set control loop for selected channel to active/inactive Read: Query Control loop for channel active/inactive Write: Set control loop for selected channel to active/inactive Example: CHACT?; 1, 0, 1, 0, 1, 1 See 7.5.1 for details on the parameter convention.

7.8.2 COMMAND PROPERTY OVERVIEW

7.8.2.1 SYSTEM

Session based parameters/commands will be initialized to default each time a new connection/session is opened to the instrument.

SYNTAX	READ WRITE	USER ACCESS LEVEL	SESSION BASED	DEFAULT VALUE	STORED IF STADEF =0
[:SYStem:] ECHO/? /<wsp><P>	RW	0	X	0	-
[:SYStem:] STArtDEFault /?<wsp>/<P>	RW	1	-	1	-
[:SYStem:] DEFault	W		-	-	-
[:SYStem:] INFOrmation?	R	0	-	-	-
[:SYStem:] DHCP/? /<wsp><P>	RW	1	-	OFF	-
[:SYStem:] IPADDRess/? /<wsp><P>	RW	1	-	192.168.0.1	-

SYNTAX	READ WRITE	USER ACCESS LEVEL	SESSION BASED	DEFAULT VALUE	STORED IF STADEF =0
[:SYStem:]NETMASK/?/<wsp><P>	RW	1	-	255.255.255 .0	-
[:SYStem:]GATEWAYIP/?/<wsp><P>	RW	1	-	192.168.0.2 55	-
[:SYStem:]MACADDRESS?	R	0	-	-	-
[:SYStem:]IPConfigDEFault	W	1	-	-	-
[:SYStem:]INTErfaceInit	W	0	-	-	-
[:SYStem:]REMOte?	R	0	-	-	-
[:SYStem:]PASSword/?/<wsp><P>	RW	0	X	-	-
[:SYStem:]TIME/?/<wsp><P>	R/(W)	0	-	-	-
[:SYStem:]ALARm?	R	0	-	-	-
[:SYStem:]CSTATUS?	R	0	-	-	-
[:SYStem:]ERRor[:NEXT]?	R		-	-	-
[:SYStem:COMMunicate:]LOCKo ut/?	RW	1	-	0	-
[:SYStem:COMMunicate:]Param eterREFresh?	R	0	-	0	-
[:STATUS:OPERation:]EVENT?	R	0	-	-	-
[:]ABORT	W	0	-	-	-
[:BOOT:]BootLoaDerRESet	W	0	-	-	-
[:BOOT:] BootLoaDerAPPend	W	0	-	-	-
[:BOOT:]BootLoaDerEXECute/?	RW	0	-	-	-
[:SYStem:]ENableLOGging/?	RW	1	-	0	-
[:SYStem:]ReadDEBUG	R	0	-	-	-
[:SYStem:]IDENTify<wsp><P>	W	0	-	0	-
[:SYStem:]ENABLEAUTOSTart/? <wsp>/<P>	RW	1	-	0	-
[:SYStem:]STArtDEFault /?<wsp>/<P>	RW	1	-	1	-
[:SYStem:]SetPASS<wsp>,<P>, <P>	W	-	-	1	-

7.8.2.2 BIAS CONTROL

COMMAND	READ WRITE	SET IN MANUAL MODE ONLY	USER ACCESS LEVEL	STORED BY SCSTAT
[:BIAS:]AUtoStArt/? /<P>	RW	-	0	X
[:BIAS:]QuicKStArt/? /<P>	RW	-	0	X
[:BIAS:]FACtoryDEFault	W	X	1	-
[:BIAS:]SETTled?	R	-	0	-
[:BIAS:]VPI/? /<P>, /<P>	RW	X	1	X
[:BIAS:]INIT/? /<P>	RW	-	0	-
[:BIAS:]VOLTagE/? /<P>, /<P>	RW	X	0	X
[:BIAS:]STAtusVOLTagE? /<P>	R	-	0	-
[:BIAS:]CONTRol/? /<P>	RW	-	0	-
[:BIAS:]OPower? /<P>	R	-	0	-
[:BIAS:]MONPower? /<P>	R	-	0	-
[:BIAS:]MUTE/? /<P>	RW	-	0	-
[:BIAS:]LOSstatus? /<P>	R	-	0	-
[:SYSTEM:]LOSThresh/? /<P>, /<P>	RW	-	0;1	-
[:BIAS:]INitPROGress?	R	-	0	-
[:BIAS:]MAXRange/? /<P>	RW	X	1	X
[:BIAS:]HWMAXRange?	R	-	1	X
[BIAS:]TRackInLOS/? /<P>	RW	-	1	-
[:BIAS:]FOFFset/? /<P>, /<P>	RW	X	1	X
[:BIAS:]FeedBackDIRection/? /<P>, /<P>	RW	X	1	X
[:BIAS:]CHannelACTive/? /<P>, /<P>	RW	X	1	X
[:BIAS:]CHannelASSign/? /<P>, /<P>	RW	X	1	X

7.9 RF AMPLIFIER CONTROL COMMANDS

COMMAND	PARAMETER TYPE
[:TransX:]AMPpeaking/?/<wsp><P>,<P>	<INT>
Sets peaking level of Transmitter RF Amplifiers,: 0 ... 255	
[:TransX:]AMPGain/?/<wsp><P>,<P>	<INT>

COMMAND	PARAMETER TYPE
Sets gain level of Transmitter RF Amplifiers; 0 ... 255	
[:TransX:]AMPSquelch/?/<wsp><P>	0 1
En- or disables squelching of RF Amplifier	
[:TransX:]PEQualizer/?/<wsp><P>	<INT>
Sets the relative power between X Polarization and Y Polarization by attenuating one polarization	
[:TransX:]TFREquency/?/<wsp><P>	<REAL>THz
Set the operating frequency of the IQ MZM. It will internally apply a calibration to optimize performance for this particular frequency.	
[:TransX:]TWAVelength/?/<wsp><P>	<REAL>nm
Set the oparting wavelength of the IQ MZM. It will internally apply a calibration to optimize performance for this particular wavelength.	

7.10 TUNABLE LASER CONTROL COMMANDS

Note that the following commands are only available if the internal tunable laser option is installed.

COMMAND	PARAMETER TYPE
[:LASER:]WAVelength/?<wsp>, /<P>	<REAL>nm
Sets or queries the wavelength setting of a tunable laser port. Value format is in Nanometer. Example: WAV 1550.012; sets Laser Port 1,1,1 to 1550.012nm	
[:LASER:]WAVelength:LIMit?<wsp>	<REAL>nm
Queries the wavelength setting limits of a tunable laser port. Value format is in Nanometer. Example: WAV:LIM?; queries Laser Port 1,1,1 Response with min and maximum limit: 1528, 1565;	
[:LASER:]FREquency/?<wsp>, /<P>	<REAL>THz
Sets or queries the wavelength setting of a tunable laser port. Value format is in Tera Hertz. Example: FREQ 192.15; sets Laser Port 1,1,1 to 192.15THz.	
[:LASER:]FREquency:LIMit?<wsp>	<REAL>THz
Queries the frequency setting limits of a tunable laser port. Value format is in Tera Hertz. Example: FREQ:LIM?; queries Laser Port 1,1,1. 2 value Response with min and maximum limit: 191.1020, 196.1020;	
[:LASER:]OFFset/?<wsp>, /<P>	<REAL>GHz
Sets or queries the frequency offset setting of a tunable laser port. Value format is in Giga Hertz. Example: OFF 11.15; sets Laser Port 1,1,1 offset to 11.15THz. Value can be positive or negative.	
[:LASER:]OFFset:LIMit?<wsp>	<REAL>GHz
Queries the offset setting limits of a tunable laser port. Value format is in Giga Hertz. Example: :OFF:LIM?; queries Laser Port 1,1,1 Response 12; It is a single value since the offset is symmetrical to 0.	
[:LASER:]POWer/?<wsp>, /<P>	<REAL>dBm
Sets or queries the optical output power target setting of a tunable laser port. Value format is in dBm.	

COMMAND	PARAMETER TYPE
Example: POW 11.15; sets Laser Port 1,1,1 offset to 11.15dBm	
[:LASER:]DIther/?<wsp> , /<P>	1,0,-1
Sets or queries the dither state of a laser port. If the feature is not available, “-1” is returned. Dither default is 1 and should always be 1 unless needed. Note that this command is implemented o Example: DITH 1; enables Laser Port 1,1,1 dither.	
[:LASER:]LIMit?<wsp>	<REAL>
Query maximum tuning Parameters of Laser in location C-S-D in csv format. <Minimum Frequency>,<Maximum Frequency>,<Fine tuning Range>,<Minimum Power>,<Maximum Power> Example: LIM?; queries Laser Port 1,1,1	
[:LASER:]CONFIguration/?<wsp>, /<P>	<REAL>
Set or Query current configuration of Laser in location C-S-D in csv format: <Frequency>,<Offset>,<Output Power>,<Output state>,<Busy state>,< Dither state>, Busy state : <INT> “1”,”0”, Only for query, if set is used, this parameter is omitted Dither state: <INT> “1”,”0”,”-1” If queried and “-1” is reported, laser does not support this feature. If set and laser does not support the feature, the parameter setting is ignored. Example read: CONF?; returns 191.42,10.134,6.12,0,1,1; The laser is set to 191.42THz, 10.134GHz FTF, 6.12dBm, output on (1) , not busy tuning (0), dither on(1) Example write: CONF 1,1,1,193,1,7,1,1; will set the to 193THz, Fine tuning 1GHz, 7dBm output power, 1: laser on, 1: dither on. Note: For SC Type lasers, Frequency and offset cannot be changed within a single command. Use 2 commands to set them separately.	
[:LASER:]BUSY? <wsp>	<INT>
Query if laser port is currently tuned “1” or settled “0”.	
[:LASER:]STATe/?<wsp>, /<P>	<INT>
Query if laser is on “1” or off “0”	
[:LASER:]MONitor?<wsp>	<REAL>
Query monitor readings from laser. Response: <LD chip Temperature>, format nn.nn, unit °C <LD base Temperature>, format nnnn.n, unit mA <LD chip current>, format nnnn.n, unit mA <TEC current>, format nnnn.n, unit mA Example: MON?; Returns 29.23,25.12,125.1,1043.2	

7.11 SCPI CODE ERROR DEFINITION

Error #	Description
100	Command Syntax Command error
101	Parameter out of range
102	No data in buffer
103	device not ready

Error #	Description
104	user level for this command not sufficient
200	Command execution error
201	user level rights to execute this command not sufficient, increase using <code>PASS</code> command
250	
251	
252	

7.12 ALARM CODE DEFINITION

BIT #	ALARM	CONDITION/DESCRIPTION
0	BIAS Value at limit	current Voltage <5% or 95% of avail range
1	Init error	An error occurred during init process
2	Feedback signal warning	feedback signal invalid
3	Gain error, feedback signal too low or too large	feedback signal too small or too large
4	generic Fault	general error
5	H/W error	Hardware error
6	Unused	-
7	DC signal warning	Photocurrent out of range warning, <5% or 95% of avail range; only if no LOS present. Control will continue to operate if warning is present (unless LOS is present as well)
8	PD1 clipping error	Input Signal warning PHDx. The feedback photodiode current saturates the electronic circuit. Change the gain using SW3 as described in section "Board and Connector description". The control will pause as long as error is present.
9	PD2 clipping error	
10	Start Init search failed	Start Init search failed due to i.e. Clipping of input signals or improper feedback signal. Initialize unit and start again. If unit settled as required by user, the warning can be ignored.
11	Feedback Fail	Feedback signal is too weak or not present. Check if Feedback Photodiodes are connected properly.
12	Not used	
13	Not used	
14	Not used	
15	Not used	

8 APPENDIX

8.1 REFERENCE SETTINGS FOR KEYSIGHT AWGS

These settings are provided for reference for a standard setup to enable a quick start. For any further details on the AWG and this software, contact Keysight support.

For this typical setup, we recommend the OMFT Gain settings of ~ 30% (Class40) or 70% (Class 60) and peaking between 0% and 50%.

Block Diagram of a typical setup

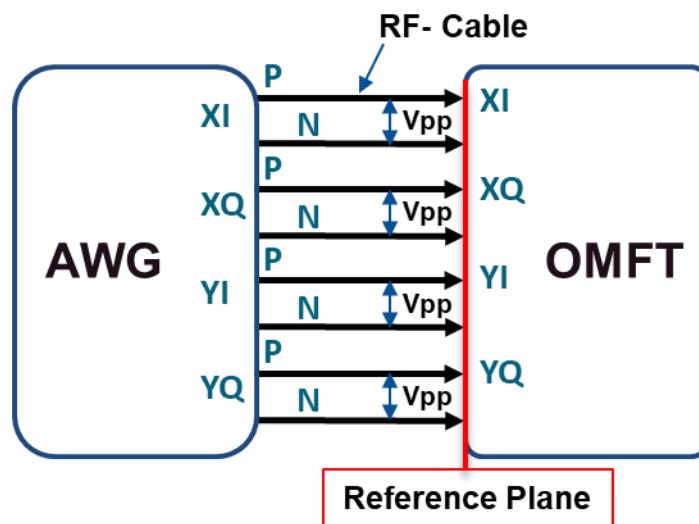

Output Settings for an AWG, 250mVpp differential, 0V offset, screenshot from Keysight Software.

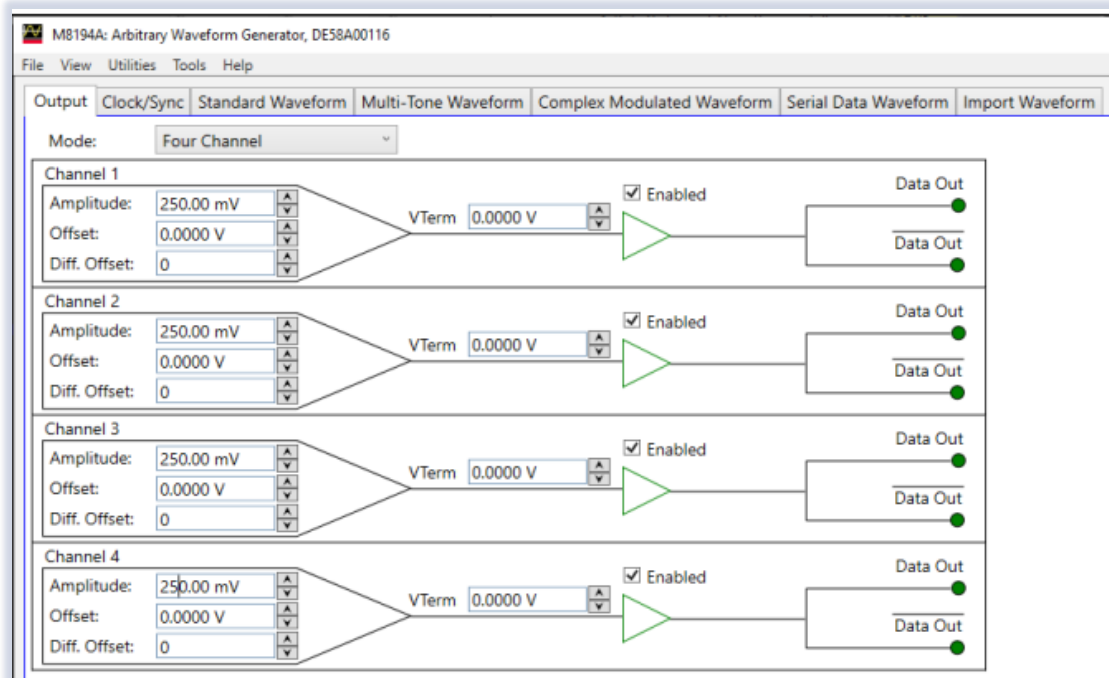

For single ended operation, make sure to properly terminate the unused RF Ports with 50 Ohm and double the output swing from the AWG to 500mV.

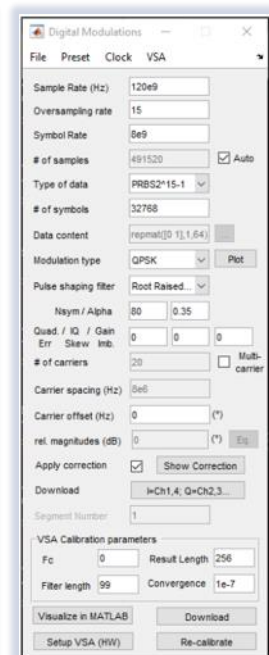
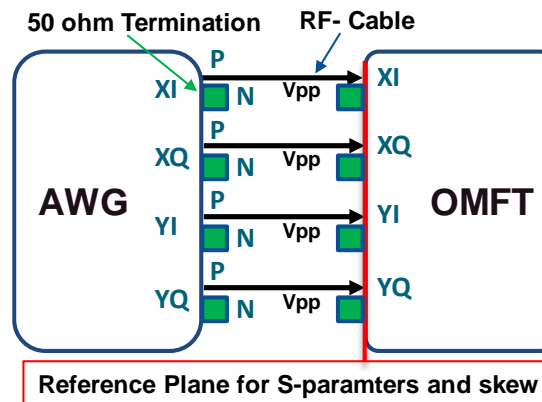

Reference Settings for the free Keysight “IQ Tool” to generate a DP-QPSK Signal

8.2 MANUAL OPERATION OF OMFT

Although the OMFT is designed to operate in automatic bias mode, it is useful to understand the impact of the modulator bias settings on the generated optical signal.

For this purpose, the user can set the OMFT to manual bias mode.

The following steps describe how to adjust the modulator bias voltages manually. It is recommended to perform the manual adjustment with NRZ-QPSK signals. Furthermore, it is assumed that the user has set up the OMFT with an output monitor coupler to record the optical output spectrum of the OMFT using a high-resolution optical spectrum analyzer (OSA) such as the ID Photonics ID OSA as well as a sampling oscilloscope (DCA) with a fast photo detector to view the optical envelope.

8.2.1 ADJUST THE BIAS VOLTAGES (“X-I”, “X-Q”, “Y-I” AND “Y-Q”) USING THE OSA:

On the OSA a spectrum for NRZ-QPSK, similar to the one shown in the figure below, should be seen. Change the bias voltages for “X-I”, “X-Q”, “Y-I” and “Y-Q” via the GUI to minimize the clock lines (marked by red circles in the figure below) as well as the residual CW carrier in the center of the spectrum. The clock lines can be suppressed as

shown in the figure in the optimum case. If not, the RF drive signals might have some skew, which needs to be de-skewed first (8.2.3 De-skewing of RF Drive).

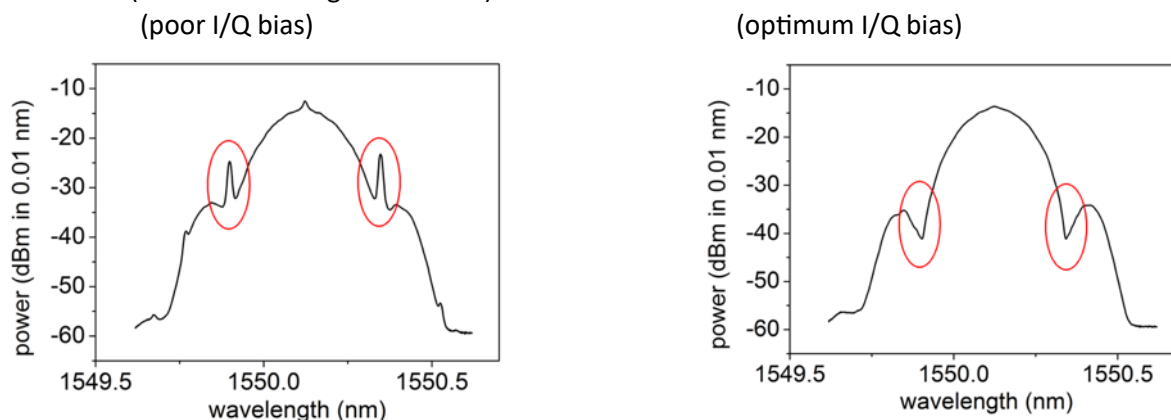

Figure 1: Optical spectrum for NRZ-QPSK at the output of the OMFT for poor (left) and optimum (right) setting of the I and Q modulator bias voltages.

8.2.2 ADJUST THE BIAS VOLTAGE FOR “X-PHASE” AND “Y-PHASE” USING THE DCA

On the DCA a picture similar to the one shown below should appear. Change the bias voltage for “X-Phase” and “Y-Phase” via the GUI to minimize the standard deviation of the high intensity level of the envelope on the DCA. An optimum optical envelope is shown in the following figure (measured for NRZ PDM-QPSK at 28 Gbd with the DCA). If the DCA envelope exhibits more features, double rails or alike, the RF drive signals might be too large or have some skew, which needs to be de-skewed first (see section 8.2.3 De-skewing of RF Drive).

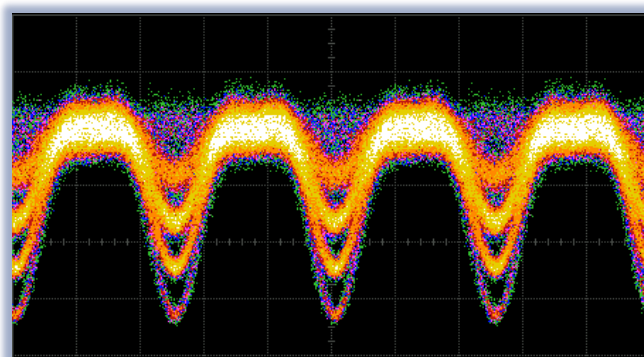

Figure 2: Optical envelope for NRZ PDM-QPSK at the output of the OMFT for optimum setting of the modulator phase bias voltage.

Finally, go back to section 8.2.1 to check if the clock lines in the optical spectrum are still well suppressed. If not, continue the manual adjustment procedure iteratively between section 8.2.1 and 8.2.2 (including possibly an RF drive signal de-skew (see section 8.2.3 De-skewing of RF Drive).

After manual optimization of the modulator bias settings, it is recommended to save these settings using the save button of the GUI.

NOTE

The optimum bias voltages strongly depend on the ambient parameters such as the temperature, temperature drift, and the RF-drive amplitude. A slight drift can occur during several hours, leading to non-optimal performance. In this case a re-adjustment of the bias voltages is recommended.

8.2.3 DE-SKEWING OF RF DRIVE SIGNALS

One reason that the optical spectrum and optical envelope cannot be well optimized by the modulator bias voltages is that the RF drive signals might have a skew (intra-bit skew between the driving signals). Follow the following steps to perform a de-skew of the signals using the DCA:

- Turn-on the RF amplifier for the “X-I”-input only. Use the horizontal time delay knob of the DCA to move a characteristic point of the optical envelope (e. g. the minimum intensity at the symbol transition) to the center of the screen.
- Next, turn-off this amplifier and turn-on the next amplifier (“X-Q”-input). A similar picture as before should appear on the DCA screen, but the characteristic point of the envelope might not be located at the center of the screen. DO NOT touch the DCA delay adjustment knob during the procedure. Now adjust the delay between your electrical data source and the “X-Q”-input of the OMFT (e. g. by re-programming the respective output of your electrical data source or by using an electrical phase shifter between the source and the OMFT input) to move the characteristic point of the envelope to the center again. This will de-skew the delay of “X-Q” with respect to the “X-I” input.

 **NOTE**

The intra-bit skew adjustment may depend on the symbol rate. Therefore, the intra-bit skew adjustment has to be re-done each time the symbol rate is changed.

- Repeat this procedure for “Y-I” and “Y-Q”, so that all four RF-channels are de-skewed. DO NOT touch the DCA delay adjustment knob during the procedure.



IDPHOTONICS^{GMBH}

SHAPING LIGHT.

HELPING ENGINEERS AND
SCIENTISTS IN
ADVANCING HOW THE
WORLD COMMUNICATES,
SENSES AND CONNECTS



TUNABLE
LASER



TRANSMITTER
SOLUTIONS

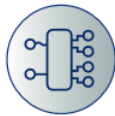

RECEIVER
SOLUTIONS



SPECTRAL
ANALYSIS



Anton-Bruckner-Strasse 6
85579 Neubiberg
GERMANY
Tel: +49-89-201 899 16
info@id-photonics.com
id-photonics.com

All rights reserved. No part of this publication may be reproduced, stored in a retrieval system or transmitted in any form, be it electronically, mechanically, or by any other means such as photocopying, recording or otherwise, without the prior written permission of ID Photonics GmbH. Information provided by ID Photonics GmbH is believed to be accurate and reliable. However, no responsibility is assumed by ID Photonics GmbH for its use nor for any infringements of patents or other rights of third parties that may result from its use. No license is granted by implication or otherwise under any patent rights of ID Photonics GmbH. The information contained in this publication is subject to change without notice.