

CORX

COHERENT RECEIVER SERIES

USER MANUAL



CORX CLASS 20, 40, 60

Applicable Part Numbers CO-RX-Cxx-10-FA, x: Wild Card

Status: 2024-12-16
Applies to Firmware 1.0.2 or later

info@id-photonics.com
id-photonics.com



CONTENT

1	General Information	3
2	CORX Series - Unit Overview	7
3	Quick Start	12
4	Description of instrument operation using the Web GUI	15
5	Connection to Remote Control Resources	20
6	Remote Control	23

1 GENERAL INFORMATION

1.1 WARNING LASER SAFETY

The laser sources specified by this user guide are classified according to IEC 60825-1 (2007) Laser Notice No. 50 dated 2007-June-24 and comply with CFR 1040.10 except deviations per Laser Notice No. 50, July 2001 Key Feature Number 4.

This device is a Class 1M laser product for use only under the recommended operating conditions and ratings specified in this document. Use of controls or adjustments or performance of procedures other than these specified in this product datasheet may result in hazardous radiation exposure.

Do not view the laser output from this device directly with optical instruments (e.g., eye loupes, magnifiers, microscopes). Viewing the laser output with certain optical instruments within a distance of 100mm may pose an eye hazard. The class 1M laser product definition is based on all conditions defined in this section.

INVISIBLE LASER RADIATION
DO NOT VIEW WITH
OPTICAL INSTRUMENTS
CLASS 1M LASER PRODUCT
(IEC 60825-1/2007)

Please pay attention to the following laser safety warning: Under no circumstances look into the end of an optical cable attached to the optical output when the device is operational. The laser radiation can seriously damage your eyesight. Do not enable the laser when there is no fiber attached to the optical output connector. The laser is enabled by pressing the 'Laser on' button in the operating software delivered with the instrument. The laser is on when the red LED on the front panel of the instrument is lit. The use of optical instruments with this product will increase eye hazard.

In doubt about laser safety requirements consult a trained laser safety instructor for local safety requirements of this product.

1.2 COMPLIANCE STATEMENT ELECTROMAGNETIC COMPATIBILITY AND DEVICE SAFETY

Hereby, we declare that this system has been designed and tested for compliance for the following directives.

1.2.1 INTERNATIONAL

IEC 60950-1:2005, modified+Cor.:2006 + A1:2009, modified
CISPR 11:2003 in accordance with EN 61326-1: 2006

1.2.2 UNITED STATES OF AMERICA

FCC 47 CFR Part 15, Subpart B Class A, Measurement process ANSI C63.4 (2009)

1.2.3 EUROPEAN UNION

EN 55022:2011
EN 61326-1: 2006
EN 61000-6-2: 2006
EN 61000-6-4: 2011
EN 61000-3-2: 2010
EN 61000-3-3: 2009

1.3 LIMITATION OF COMMUNICATION INTERFACES

Operation of all USB Ports is limited to a maximum cable length of 3m and a maximum length of 30m for all Ethernet ports present.

1.4 EUROPEAN WEEE DIRECTIVE COMPLIANCE

ID PHOTONICS has established processes in compliance with the Waste Electrical and Electronic Equipment (WEEE) Directive, 2002/96/EC. This product should not be disposed of as unsorted municipal waste and should be

collected separately and disposed of according to your national regulations. In the European Union, all equipment purchased from ID PHOTONICS can be returned for disposal at the end of its useful life. ID PHOTONICS will ensure that all waste equipment returned is reused, recycled, or disposed of in an environmentally friendly manner, and in compliance with all applicable national and international waste legislation. It is the responsibility of the equipment owner to return the equipment to ID PHOTONICS for appropriate disposal. If the equipment was imported by a reseller whose name or logo is marked on the equipment, then the owner should return the equipment directly to the reseller. If you have questions concerning disposal of your equipment, contact ID PHOTONICS's at WEEE@id-photonics.com.

1.5 LINE VOLTAGE SELECTION

The unit operates from any single-phase AC power source that supplies 100 ~ 240VAC at a frequency at 50/60 Hz. The input line voltage setting is done automatically by the power supply.

1.6 SERVICE

Do not attempt to service or adjust this instrument unless an authorized person is present. Do not install substitute parts or perform any unauthorized modifications to this instrument. Contact ID Photonics or your local distributor to obtain service support.

1.7 HELP AND USER FEEDBACK

ID Photonics GmbH is dedicated to continuously improve customer experience of our products. Thus, if you have any feedback that might help us to improve our products send us an E-Mail to: feedback@id-photonics.com For support inquiries, please contact us via E-Mail support

1.8 OPTICAL OUTPUT OF LASER PORTS

Each laser port features a polarization maintaining Fiber output which can be both used with standard single mode fibers and polarization maintaining fibers. The emitted E-field is oriented along the slow axis of the fiber.

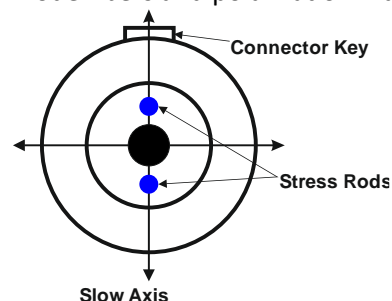

1.9 SAFETY

1.9.1 GENERAL SAFETY PRECAUTIONS

The following general safety precautions must be observed during all phases of operation of this instrument. Failure to comply with these precautions or with specific warnings elsewhere in this manual violates safety standards of design, manufacture, and intended use of the instrument.

ID Photonics assumes no liability for the customer's failure to comply with these requirements.

Before operation, review the instrument and manual for safety markings and instructions. You must follow these to ensure safe operation and to maintain the instrument in safe condition.

1.9.2 GENERAL

This product is a Safety Class 1 instrument. The protective features of this product may be impaired if it is used in a manner not specified in the operation instructions.

1.9.3 ENVIRONMENT CONDITIONS

This instrument is intended for indoor use in an installation category II, pollution degree 2 environments. It is designed to operate at a maximum relative humidity of 95% and at altitudes of up to 2000 meters.



Refer to the specification tables for the ac mains voltage requirements and ambient operating temperature range.

! NOTE

Before connecting electrical power to the unit, make sure the unit could acclimatize to ambient temperature for at least 2 hours to avoid damage by i. e. condensed humidity on electrical parts inside the unit.

1.9.4 FUSE REPLACEMENT

For continued protection against the possibility of fire, replace the fuse only with a fuse of the specified voltage, current and type ratings.

1.9.5 BEFORE APPLYING POWER

Verify that all safety precautions are taken. The power cable inlet of the instrument serves as a device to disconnect from the mains in case of hazard. The instrument must be positioned so that the operator can easily access the power cable inlet. When the instrument is rack mounted the rack must be provided with an easily accessible mains switch.

1.9.6 MAXIMUM RATINGS

ALWAYS operate the unit within the maximum ratings. Ignoring these limits may result in permanent damage to the unit and loss of warranty.

1.9.7 GROUND THE INSTRUMENT

To minimize shock hazard, the instrument chassis and cover must be connected to an electrical protective earth ground. The instrument must be connected to the ac power mains through a grounded power cable, with the ground wire firmly connected to an electrical ground (safety ground) at the power outlet. Any interruption of the protective (grounding) conductor or disconnection of the protective earth terminal will cause a potential shock hazard that could result in personal injury.

1.9.8 DO NOT OPERATE IN AN EXPLOSIVE ATMOSPHERE

Do not operate the instrument in the presence of flammable gases or fumes.

1.9.9 DO NOT REMOVE THE INSTRUMENT COVER

Operating personnel must not remove instrument covers. Component replacement and internal adjustments must be made only by qualified personnel.

Instruments that appear damaged or defective should be made inoperative and secured against unintended operation until they can be repaired by qualified service personnel.

Opening the instrument will result in loss of all warranty given for the instrument and may exhibit lethal health risks.

Keep away from live circuits inside the equipment. Operating personnel must not remove equipment covers. Only factory authorized service personnel or other qualified service personnel may remove equipment covers for internal subassembly or component replacement or any internal adjustment. Do not install substitute parts or perform any unauthorized modification of the equipment or the warranty may be voided.

1.9.10 VENTILATION

Keep a space of 30 cm or more between the rear side of the device and any other objects such as walls to guarantee sufficient cooling of the device.

Never block ventilation openings.

1.9.11 CLEANING THE INSTRUMENT

To avoid personal injury, power down the device and disconnect it from line voltage before performing any of the following procedures.

To clean the exterior surface, perform the following steps:

Remove loose dust on the outside of the instrument with a lint-free cloth.

Use a soft cloth dampened with water to clean the device. Use 75% isopropyl alcohol solution as a cleaner. Do not use any abrasive or chemical cleaning agents.

1.9.12 SAFETY SYMBOLS ON INSTRUMENTS

1.9.12.1 WARNING OR CAUTION



If you see this symbol on the product, you must refer to the manuals for specific Warning or Caution information to avoid personal injury or damage to the product.

1.9.12.2 ESD SAFETY WARNING



This sign indicates that the respective modules, boards or RF inputs and outputs are susceptible to damage by electro static discharge (ESD), and require proper protection procedures for storage and handling.

1.9.12.3 OUTPUT OF LASER RADIATION WARNING



This sign does indicate a source of optical radiation that may emit close to the location this label is present. Follow according laser safety procedures as listed below and defined in general rules at all times.

1.9.12.4 WEAR EYE PROTECTION

Wear eye protection if exposure to high-intensity rays or laser radiation exists according to Laser safety rules and best practices.

1.9.12.5 DO NOT DIRECTLY VIEW OPTICAL LASER PORT OUTPUT

Under no circumstances should you use any optical instruments to view the optical laser port output directly.

1.9.12.6 PRECAUTIONS WITH CONNECTORS

It is essential to ensure that all optical connectors are in good condition. Dirty connectors can lead to poor performance, while broken connectors can cause damage to other equipment!

Before an optical connector is used, check it visually by using an optical microscope as recommended by the manufacturer of the connector. If the connector needs to be cleaned, apply the cleaning procedure recommended by the manufacturer of the connector.

Make sure you are familiar with these issues to avoid damage to your device and possible violation of warranty.

NOTE

Before connecting the inputs or outputs to any measurement equipment or device under test, make sure that a suitable attenuator, if necessary, is fitted.

2 CORX SERIES - UNIT OVERVIEW

2.1 OPERATING PRINCIPLE AND BLOCK DIAGRAM

The Coherent Optical Receiver CORX is a fully integrated optical frontend unit for the coherent detection of optical high-speed signals on two orthogonal polarization that are converted into the electrical domain using transimpedance amplifiers (TIAs). The TIAs can be operated in a constant gain mode (Manual Gain) and a constant output amplitude mode (Auto Gain). The auto gain mode will keep the output amplitude, within limits available, constant for changes of the optical input power.

The unit also comprises a tunable laser that can be used as the local oscillator when connected with the supplied PM patch cord.

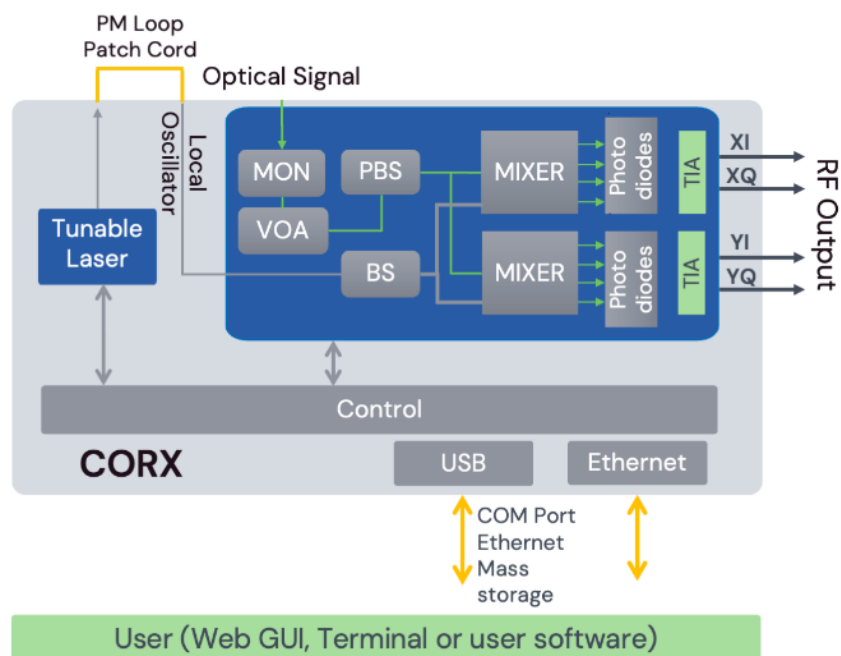

2.1.1 OPTICAL SIGNAL PATH

The optical signal power is monitored by a user readable power monitor at the input of the unit. A user settable Variable Optical Attenuator (VOA) allows to optimize the power to the receiver optics.

The optical signal is split into 2 orthogonal polarizations and mixed with the local oscillator signal by two separate Mixers. The 4 signals are put into 4 balanced detectors which convert the optical signal into single-ended electrical RF signals.

The VOA provides a quasilinear transfer curve between 0% (minimal attenuation) and 100% (>25dB attenuation).

2.1.2 TRANSIMPEDANCE AMPLIFIERS (TIA)

The photocurrents are enhanced via 4 identical RF amplifiers. The CORX allows for control and monitoring of several parameters of the TIAs.

PARAMETER	DESCRIPTION
Gain Mode	There are 2 Modes: Auto Gain: The Gain of the TIA is internally controlled to achieve a constant RF Output amplitude at the output that is independent of the signal strength at the input. I. e. if the Signal input strength is changed, it will be compensated in this mode by internally adapting the TIA gain within available limits. This can be helpful for detection of Single Polarization Signals or in case of PDL in the test system.

	Constant Gain: The Gain of the TIAs is fixed to the level set by the user. Any change of signal intensity will yield in an RF amplitude change within the limits of amplitude
Gain/Amplitude Level	The TIA gain can be controlled for each channel individually. Depending on Gain mode selected, the reference Amplitude or Gain is set via these controls.
Peak Indicator	Each channel features a peak indicator that detects the RF swing for each channel. It can be used to analyze signals that are too small or a nonlinear saturation of the TIAs by too much gain or signal at the input.
Peaking	<p>This feature allows optimizing the transfer function of your system by elevating the gain for higher frequencies. The peaking feature depends on the device variant:</p> <p>Class20: no peaking feature</p> <p>Class40: 0, 1, 2, 3</p> <p>Class60: no peaking feature</p>

2.2 FRONT SIDE OF UNIT

The front side provides access to all relevant connectors, power on/off button and Status information LEDs for operation of the device:

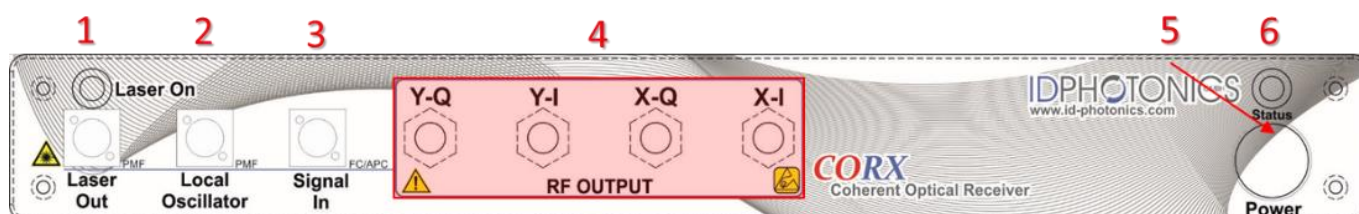

2.2.1 SIGNAL PORTS

- (1) Tunable Laser Output, Polarization Maintaining (PM) - FC/APC, NK with Laser Status indicator LED
- (2) Local Oscillator Input, PM - FC/APC, NK
- (3) Signal Input, SSMF - FC/APC, NK
- (4) RF Output Ports for XI, XQ, YI, YQ, 1.85mm “V-Style” female connectors
- (5) Power Button with Power LED
- (6) Status LED

2.2.2 STATUS INFORMATION LEDS

LED	DESCRIPTION
Power LED	Indicates if the device is switched on
Status LED	Indicates the readiness of the unit Orange: Device not ready, booting Green: Device ready

	Red: Alarm present. Check WebGUI for details of alarm Flashing: Device identification was activated by a user via remote control. The device remains fully functional. This feature allows to identify which device is remote controlled via the WebGUI. This is helpful if multiple devices are operated in a single setup. This is helpful if multiple devices are operated in a single setup.
Tunable Laser Status LED	Indicates the output status of the built-in Tunable Laser. LED Off: Laser is Off LED On: Laser is On LED blinking: Laser is in tuning process

2.3 REAR SIDE OF UNIT

The rear side hosts electrical connectors that can be utilized by the user.



2.3.1 POWER SOCKET (10)

Electrical power is supplied using a VDE 0625, EN 60 320, C13 type electrical connector. Only use the supplied cable or an identical cable that conforms to the aforementioned standard to connect to the unit. The unit automatically adapts to local power line specifications within the range printed on the unit near the socket. The socket has a main power switch which must be enabled to operate the device.

2.3.2 DATA PORTS

Ethernet (12) – The RJ45 jacket is used to connect the unit to Ethernet networks based on the IEEE 802.3 standard. Per factory default, the unit is set to a fixed IP Address 192.168.0.1. The IP address configuration can be changed via Remote control or GUI. We recommend to initially connecting via USB to set up the Ethernet interface first.

See section 0 for details on how to establish an application layer connection to remote control the unit.

USB (11) – The USB 2.0 type B jacket is used to connect the unit a host computer to be able to operate the supplied GUI or perform remote control on the unit. See section 3.3 for details on how to establish an application layer connection to remote control the unit.

2.3.3 LASER INTERLOCK (13)

Interlock is a safety feature to be used in cases of emergency. It is not intended to be used in regular operation. Interlock is active when the jumper located at the rear panel is removed. In this state, the laser cannot be controlled as electrical power is removed from it.

Note that all lasers remain off after the interlock has been triggered and require to be switched on again using software control even after interlock was released.

2.4 STANDARD ACCESSORIES

Each unit is delivered with the following accessories

Data medium (USB Stick): This medium contains information such as test report, manual, drivers etc.

Manual: Paper copy of user manual

Power Cable N-type: The Power cable provides AC electrical power to the unit

USB Cable: Use this cable with a host PC to connect to the unit via USB

Ethernet Cable: Use this cable with a host PC to connect to the unit via Ethernet

30cm PM patch cord, FC/APC to FC/APC: This patch cord can be used to connect the integrated local oscillator (LO) laser output to the LO input of the receiver

2.5 OPTIONAL ACCESSORIES

2.5.1 19" RACKMOUNT ADAPTOR

This adaptor is used to mount one CORX chassis in a standardized 19" Rack in 1 HE slots.

For mounting instructions, see the separate guide which is supplied in case you have ordered these accessories.

2.6 TUNABLE LASER

The unit hosts a tunable laser that can be used as a local Oscillator. The laser output is routed to the front panel of the instrument.

2.6.1 TUNING PROCESS

Coarse tuning allows accessing the full specified tuning range while fine tuning (FTF) allows for offsetting from the coarse tuning set point by a small range. The resulting set point is the sum of coarse tuning set point and FTF/fine tuning value.

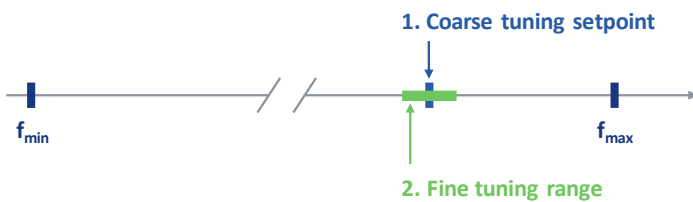

2.6.1.1 COARSE TUNING

This tuning mode allows tuning the laser to any frequency of the available range specified for the laser port. The tuning process will require the output to be disabled for a short period of time.

Description of tuning process:

1. Output will be switched off (~1 second)
2. Output is switched on using new frequency
3. Power is increased until final output power is reached. Maximum tuning times for this step differ from laser type to laser type.
4. Power is stabilized, tuning process is completed.

Note that the time to tune the laser is the actual time required to tune the laser, the software based tuning indicator may indicate a tuning state for a longer time period than the actual tuning requires.

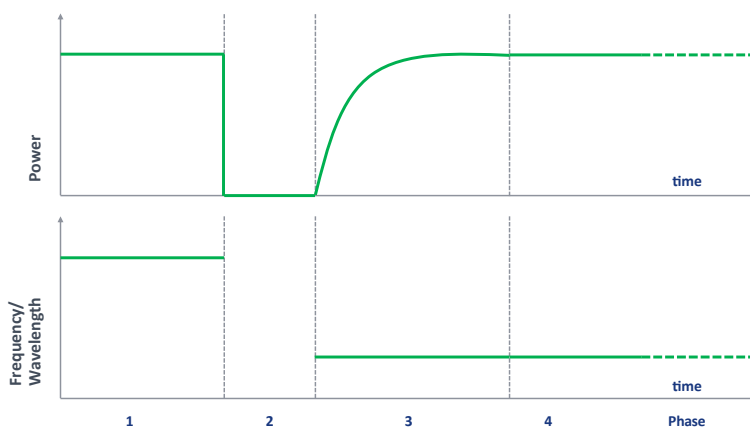

2.6.1.2 FINE TUNING (FTF)

Fine tuning allows detuning the laser within a small range from the target frequency set using the coarse tuning parameter. The laser will detune to the target setting with output power on during the tuning process which changes the output frequency in a linear ramp.

1. –Tuning is triggered
2. The Tuning process executes at a rate of 0.11 GHz per second. Power remains constant.
3. Laser settles on new value

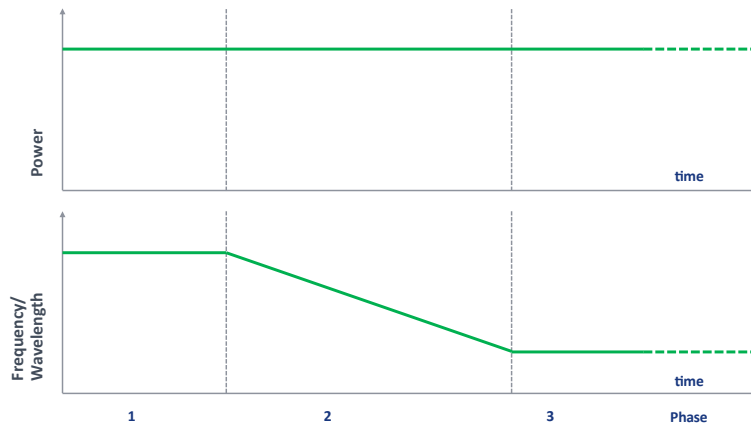

3 QUICK START



3.1 PREPARATION

Make sure to have a host PC available that satisfies the following requirements: Windows 7 or higher Operating System, Installed Web Browser MS Edge, Chrome or Firefox.

NOTE

Before switching on the unit, connect all cables to the unit.

3.1.1 OPTICAL CABLES

All optical ports are FC/APC, narrow key type connectors.

- Connect the supplied PM patch cord from “Laser Out” (1) to Input “Local Oscillator” (2)
- Connect an RF modulated signal to “Signal In” (3). Make sure that the power level of the signal is within the limits defined in the CORX specification

3.1.2 RF CABLES

All ports are 1.85mm, V-type, female type.

- Make sure that you operate in an ESD safe environment to avoid permanent damage of the unit.
- Connect the 4 RF Outputs to your test device and/or make sure all RF ports are properly terminated by 50 Ohms up to at least 67GHz (4)

3.1.3 OTHER, LOCATED AT BACK

- Connect either or both supplied USB cable (11) and Ethernet cable (12) to your host PC or host Network to the accordingly labeled ports located at the back of the unit.
- Connect the supplied Power Cable to the “Line” port (10).

3.2 OPERATING THE UNIT

This section contains redundant information from other chapters but is useful for a first-time usage of the instrument.

- Power up the unit using the main power switch located at the back of the unit “Line” (10).
 - Press the power button (5) located at the front panel. The green light in the button should light up. The Status LED should become orange (6).
- Wait until the boot sequence is completed. This is indicated by the status LED becoming green.
 1. **For USB** based access, drivers will be installed automatically for Windows 10 or later. To access the WebGUI, the USB virtual Ethernet IP address is needed. If the DNS configuration of your computer

allows, the IP address can also be retrieved by entering the command shell “ping corx.local” or retrieve the USB IP address from the label located at the rear of the unit.

2. **For Ethernet** based access, the **default IP** of the unit is **192.168.0.1**. Make sure that the host PC IP is in the same subnet as the laser unit (192.168.0.x). If this is not the case, you can change the IP settings of the unit using the USB Port of the unit. Use <http://corx.local/> as an alternative to the IP address to connect to the unit if your DNS configuration of the network allows this access.

- For troubleshooting and more details on remote connection, see 0.
- Open your Web browser, enter <http://corx.local/> or the IP address in the address field of the browser and hit <enter> to access the WebGUI. The Webpage allowing to control the unit remotely should open now.

3.3 ENABLE THE UNIT USING THE WEBGUI

- Select Tab “Rx Control”

Wavelength [nm]	Frequency [THz]	FTF [GHz]	Set Power [dBm]	Actual Power [dBm]	Laser	State
1548.515	193.6000	0.000	16.00	16.00	ON	ON

1. Enable your optical test signal into port “Signal In”. The Optical Input power monitor should now show the optical power level of your signal (1)
 2. Set the Tunable Laser Source to the Power and Frequency needed for your application. Typically, the Laser frequency is set to the carrier frequency of the signal you want to demodulate. Start with minimum power possible for the laser. Enable the Laser and wait for the laser to finish tuning. You should see that the Photocurrent monitor readings increase as the laser power increases (2).
 3. Select Manual Gain control (3).
 4. Set all TIA gain settings to 10% (4)
 5. Enable the TIA (5). The password for user level 1 is “IDP”.
 6. Decrease the VOA attenuation slowly from 100% towards 0%. You should now see the Peak Indicators going up. If they remain low, you can increase the TIA gain control further. If they persist at a low level, check the carrier frequency of your test signal and match the LO frequency to it. (6)
- Check the RF outputs with your testing device such as an Oscilloscope. You should see a small signal on all channels. Now you can start to increase the TIA gain to bring the RF amplitude to a suitable range for your testing device. Note that excessive gain will yield in nonlinearities for the RF signal.



- You are ready to use the unit!

3.4 REFERENCE SETTINGS

For a set of known good start values, please refer to the Inspection report delivered with your unit. These are typical settings enabling good performance of the device in a typical setup.

A printed copy of the Inspection report is provided as part of the package. Additionally, a PDF copy can be retrieved from the WebGUI via the  button.

Typical Reference Settings are listed below.

- Local Oscillator Power = 12 dBm
- Signal Power = -9 dBm
- TIA mode: Auto Gain (AG), ~ 20% Gain Setting
- Results in ~ 200 mV out RF Swing
- VOA Attenuation at 0 % (= minimum loss)

4 DESCRIPTION OF INSTRUMENT OPERATION USING THE WEB GUI

The unit can be accessed by any devices such as smartphones, PCs etc. that are able to operate a web browser. The Web Interface was tested on Windows 7 and Windows 10 Computers using Edge, Chrome and Firefox and iPhone/iPad using Safari browser. Note that we cannot guarantee operation in any Browser environment in general.

If connected via USB, a virtual Ethernet interface is installed on the host system so that the Web Interface based access is enabled.

To access the unit, enter `http://corx.local/` or the current IP address of the unit into the address field of the Web browser to open the WebGUI. For details, see 0.

4.1 STATUS BAR

The status bar located at the top of the WebGUI shows the current optical input power into the receiver Monitor.

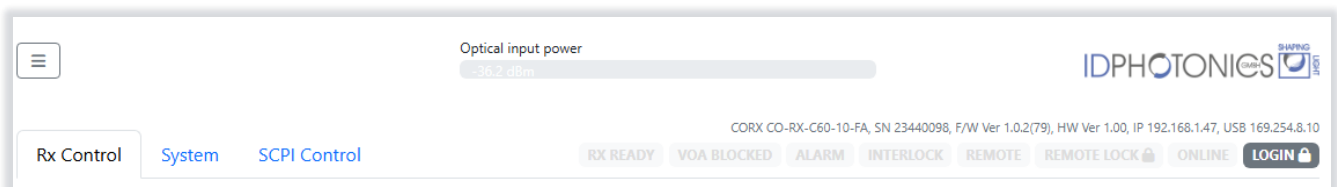

Status indicators highlight the status of the unit:

“Rx ready”: Indicates readiness of unit

“VOA blocked”: Integrated VOA before the receiver is in blocked mode (= max. attenuation)

“Alarm” indicates pending or latched alarms. Click on the button to retrieve *alarm details* in case of a failure. Alarms can be latched so that intermittent occurrences can be detected by the user. These alarms can be acknowledged and cleared by pressing “Clear latched alarms”

“Interlock” indicates the status of the interlock jumper located at the rear of the unit. If the jumper is removed or the lock released, the indicator will light up red lasers are put into physical shutdown. Install the jumper or toggle the lock back to enable the laser again. Then, press the Status on/off button to switch the laser on.

“Remote” - A Remote connection is currently established to the unit

“Remote Lock” indicates if another user has blocked remote access to the unit. If this status is set, other remote connections cannot alter settings of the device. See 6.8 for details.



“Online” – Indicates that the WebGUI is currently connected to the instrument and shows current data. If the information flow is stalled, the “working” status is shown trying to reconnect to the unit.

“Login” allows elevating the user level to perform tasks requiring access rights. Any of these tasks are indicated by a  symbol. If the user level is raised, the button indicates the current user level **User Level 1**. For details see 6.4.

“Device Info” provides info such about the unit: Device P/N, Serial Number, Firmware Version, Hardware version and current IP configuration of the Ethernet interface.

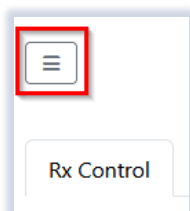
4.2 OPTIONS BUTTON



The  Button gives access to a pull-down menu that provides resources (Downloads, Remote Control and Help) as well as unit management to restart, shutdown the unit or to update the device firmware. The lock indicates that the user level must be raised to be able to perform use this function. Use the  button to elevate the user Level.

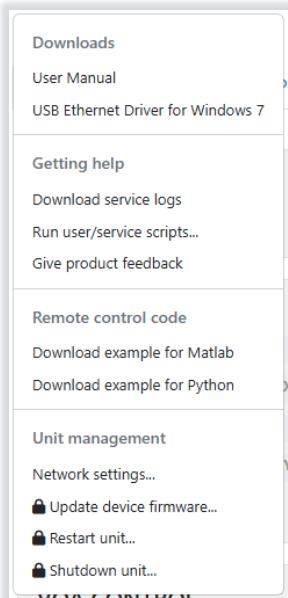

The “**Downloads**” section provides resources such as a PDF copy of this manual which are downloaded to the host PC by clicking on it.

“**Download service logs**” will collect debug information of the system in case of issues. Allow up to 2 minutes to finish the collection, save the binary data to the host PC and send it to ID Photonics for troubleshooting. The files are not user viewable.

“**Run Service scripts**” allows executing scripts provided by ID Photonics for troubleshooting.

“**Give product feedback**” In case the host PC is connected to the internet, this will open a web form on the ID Photonics Website providing feedback about this product.

The “**Remote Control Code**” section provides some code examples that can be used to remote control the unit. These are downloaded to the host PC by clicking on it.

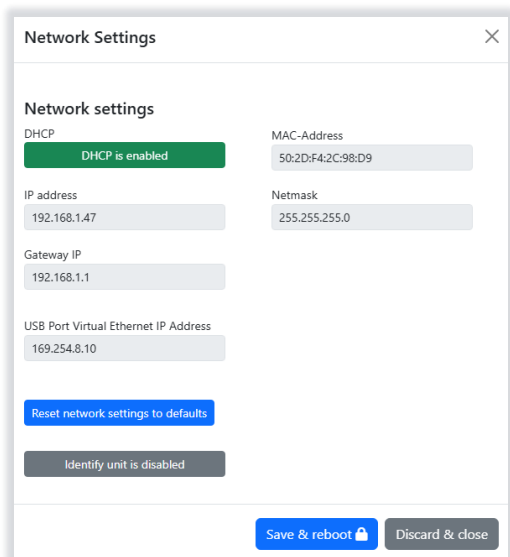

“**Network settings**” displays the current settings of Ethernet ports installed in the unit. The view may look different depending on the type of device being used. Elevate the user level by entering the password “IDP” to change the Network settings.

“**MAC Address**” provides the MAC address of the physical Ethernet interface of the unit. This cannot be changed.

“**USB Port Virtual Ethernet IP Address**” shows the Virtual Ethernet IP Address of the unit. Note that this IP cannot be changed. For details, see 5.2.

“**Reset all network settings to default**” will set all network settings to factory default. The change will only become effective after a reboot.

“**Identify unit**” allows the identification of the unit currently controlled by this session in case several units are present on the network. It will flash the Status LED located at the front of the unit.

“**Update Device Firmware**” allows installing a new firmware into the unit. Please follow the following steps:

1. Connect via the Web Interface
2. Elevate the user level to at least 1 by entering the password in Login. The default password is “IDP”. Note that this may have been changed by a user before on the unit at hand.

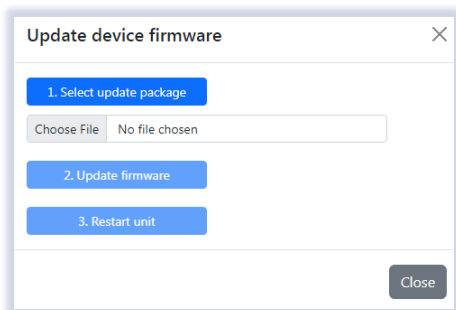

3. Use the “Choose File” button” to locate the firmware file provided by ID Photonics. The new firmware is a single ZIP File. Do not extract this archive. Select the file and then press button “Update Firmware”. Do NOT close the browser window yet.

4. The file is first uploaded to the device, checked and installed. This takes less than 1 Minute to complete. Once the process is complete, a message will inform the user that the installation is complete.

5. Press “Restart unit” to perform a warm start of the unit to activate

the new firmware.

6. After restart, make sure to press “reload” in your web browser window to empty the cache as some information may not be updated otherwise. The current installed firmware version is shown on the status section on the top right side and allows to determine if the upgrade was successful. Alternatively, query “*idn?”. The firmware info is highlighted in the following typical response:

CORX CO-RX-C60-10-FA, SN 23440098, F/W Ver 1.0.2(79), HW Ver 1.00.

“**Restart unit**” will restart the connected unit after a popup confirms the reboot action. The Laser will be switched off upon execution

“**Shutdown unit**” will close the operating system of the connected unit to avoid data loss before removing electrical power after a popup confirms the action. The Laser will be switched off upon execution. Toggle the electric power to restart the unit.

4.3 “RX CONTROL” TAB

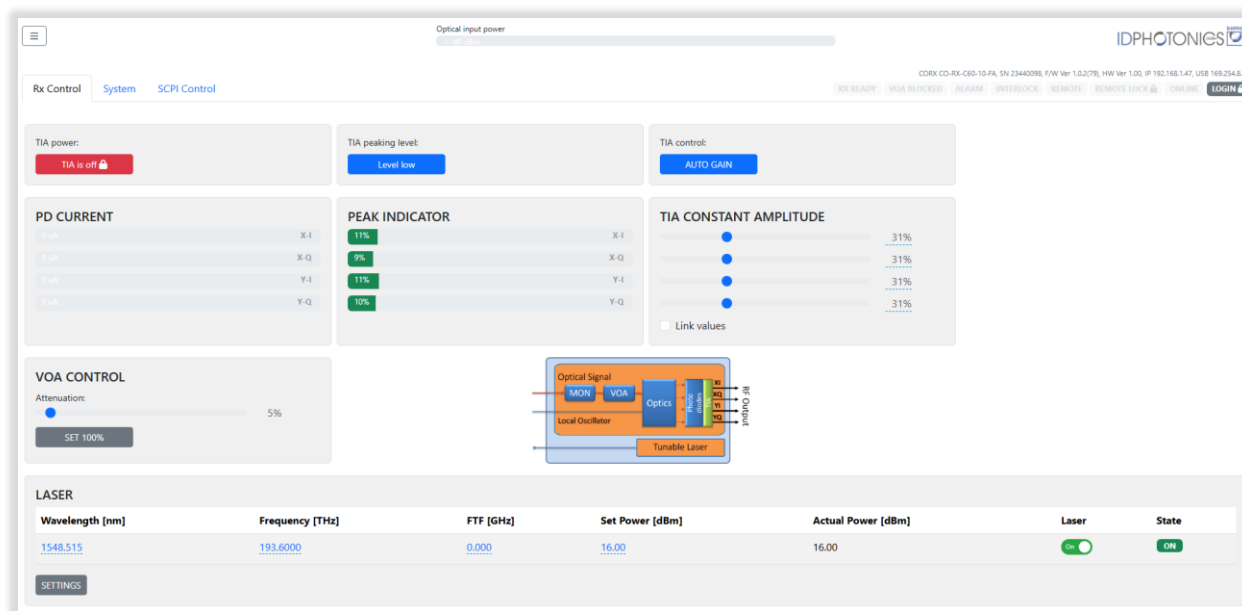

TIA Power – Switch on/off the transimpedance amplifiers (TIA) of the unit. The amplifiers are switched off by default. Press this button to enable the RF output in user level 1 (default password “IDP”).

Rx Control – Toggles between Auto Gain and Manual Gain. For details, see 2.1.2.

Peaking – (only available on some models) Elevates the transfer curve for higher Frequencies. For details, see 2.1.2.

PD Current – This indicator shows the photocurrent present at each Photodiode



Peak Indicator – This indicates the RF amplitude currently present at the output of the unit. For details, see 2.1.2.

TIA Constant Amplitude (Auto Gain only) – This control will set the amplitude of the RF output signal. An internal control will vary the gain of the TIAs to maintain a constant RF Amplitude. So, changes of the input signal strength will be compensated within available limits. For details, see 2.1.2.

TIA Constant Gain (Manual Gain only) – This control will set the gain of the TIAs to a fixed value. Any change of the input signal strength will result in a change of the RF output amplitude within swing limits available by the TIAs. For details, see 2.1.2.

VOA Control– This control sets the level of attenuation in the receiver, for details see block diagram 2.1.

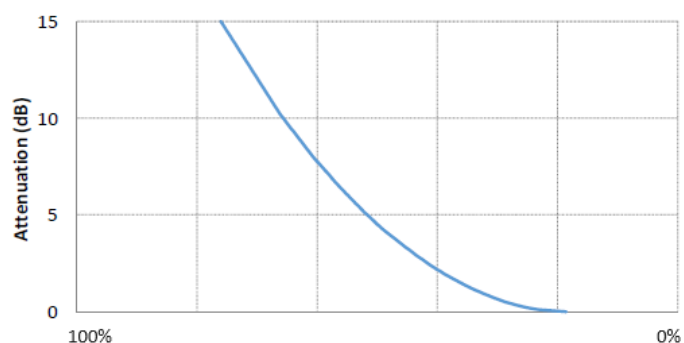

4.3.1 LASER SETTINGS

The section is used to control the integrated tunable laser and indicates its status.

Laser settings

Port
1-1-1

Wavelength (1527.605 .. 1568.609 nm)
1568.609

Frequency (191.1200 .. 196.2500 THz)
191.1200

FTF (+/-10.00 GHz)
0.00

Set Power (8.8 .. 17.8 dBm)
8.8

Laser on/off status
LASER OFF

Note, laser out will be switched off during tuning if frequency parameter is changed.

Save changes Close

Change one Parameter – To change the setting, click on the corresponding parameter and enter a new value which will be set to the laser port after the “ok” button was clicked.

Change several Parameters at once – Click on the “Settings” button. A Popup opens in which parameters can be changed. Complete the change by clicking “save changes” or discard by clicking “close”. The advantage of this method is that all parameters are changed in one tuning cycle as opposed to several subsequent cycles if the parameters are entered one after the other as described before.

Click on the Laser on/off button if you wish to en- or disable a laser port using the current settings.

When tuning, this button will switch to an indicator “busy” until the laser has settled to the state set by the user.

4.4 “SYSTEM” TAB

This tab gives an overview of the device configuration and status.

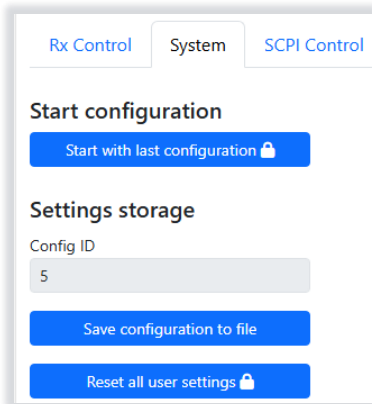

“**Start configuration**” allows two settings:

“**Start with *Factory defaults***” starts the laser ports with predefined settings defined by ID Photonics.

“**Start with Last Configuration**” will save the settings each time it is changed by the user and set these upon restart of the unit.

“**Config ID**” is a counter that increases each time a setting is changed on the device. This is helpful for remote control to detect if a concurrent session as changed parameters.

“**Save configuration to file**” will generate an ASCII text file with SCPI commands that can be used restore the current configuration.

“**Reset all user settings**” is will reset all user settings, the unit will then initialize to the factory settings.

4.5 “SCPI” TAB

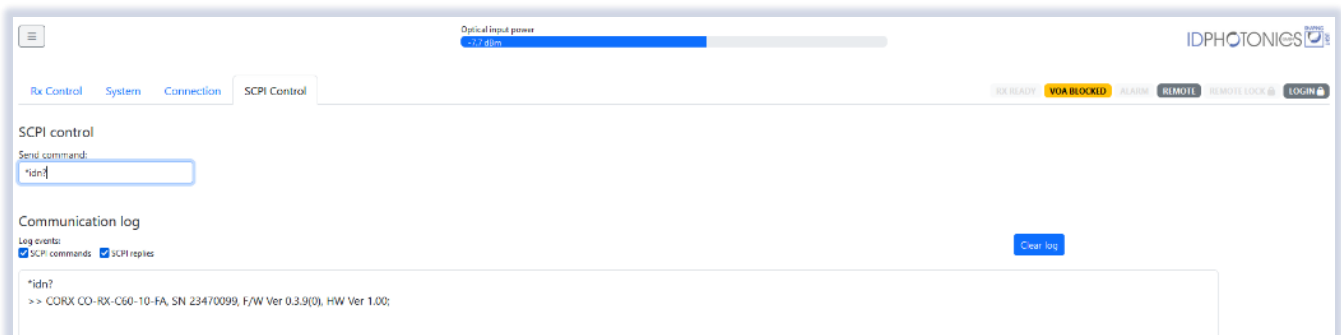

This tab allows tracing of SCPI commands that are sent via remote interfaces for debugging or for generation of templates for scripts. This will also record user interactions in the Web GUI to allow recording the commands required to recreate the current state.

Check the boxes to select the parts of the communication you wish to monitor.

5 CONNECTION TO REMOTE CONTROL RESOURCES

This section contains more in-depth information on how to setup the remote interfaces on a host PC and basic principles of the laser.

5.1 ETHERNET CONNECTION

This section covers connectivity using Ethernet, skip this section if you plan on using USB.

The default IP address is 192.168.0.1, DHCP off. If you plan to connect using the Ethernet interface, make sure the host PC is within the same subnet as the CORX Ethernet Interface (The PC IP Address is 192.168.0.x then). The connectivity can be tested by opening a command shell (type “cmd” in windows search field and hit <enter>, a “black window with a DOS shell should open) and executing the command “ping 192.168.0.1”.

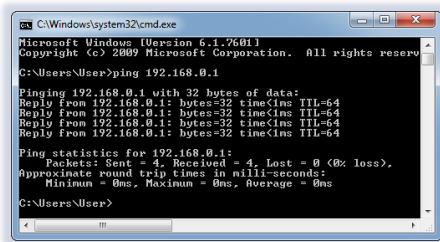

The unit possesses two IP Addresses. One for the physical Ethernet interface and one for the virtual Ethernet Interface generated by a USB connection. Only the one of the physical Ethernet interface settings can be changed and is handled in this section.

5.1.1.1 HOST COMPUTER CAN CONNECT TO CURRENT IP ADDRESS OF CORX

Enter the IP Address of unit in the browser address field of your host PC browser (default: 192.168.0.1). The CORX GUI should now open in the browser window. Go to connection tab, raise user level by entering password “IDP”, now change the IP settings and restart the unit to take the new setting into effect.

5.1.2 OPENING A REMOTE CONNECTION VIA ETHERNET

The device supports a session based remote access on Port #2000.

Start the terminal program “putty.exe” supplied with the unit or use any other terminal program.

Set the following parameters in Putty and open the connection:

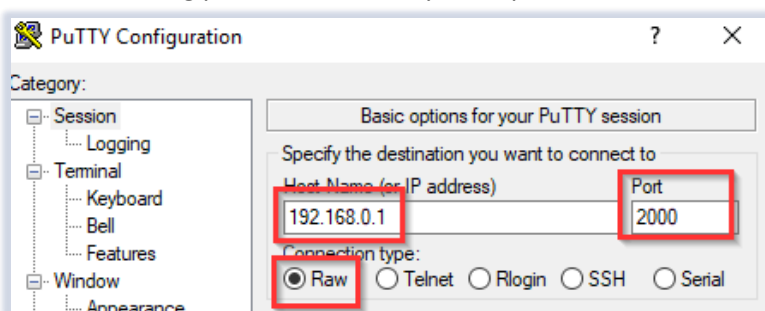

Alternatively, to the default IP Address shown above, enter <http://corx.local/> or the IP address currently set to the unit.

Note that there must be a valid route on the IP layer between the device and the host PC (i. e. the ethernet port of the host PC is set to the same subnet as the device, for example 192.168.0.2) must be established before continuing. Use a command shell and command “ping corx.local” to test the route.

Once the connection is established, type in “*idn?” and hit <ENTER>. The unit responds with its *idn? String.

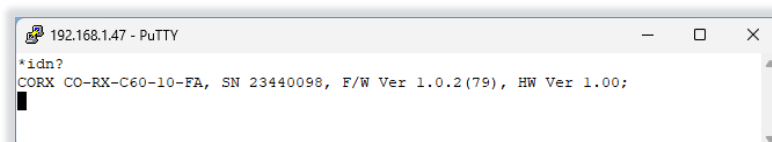

Alternatively, a request based remote control via http Port 80 is possible. To test this, open a browser window and type the following string into the address field:

```
http://corx.local/scpi/*idn?
```

For more details, see section 6.2.

5.2 USB CONNECTION

This section covers connectivity using USB, skip it if you plan using Ethernet.

Once the unit is powered up and the USB cable is connected to the host computer for the first time, a new device installation should be triggered automatically within Windows. For Windows 10 or later, this will be completed automatically. For Windows 7, install the necessary driver using the file located on the installation medium that is part of the accessories.

Upon successful installation, you can check the installation by opening Windows Device Manager (Press <Windows> key + X). It should show 3 devices:

- 1. A virtual USB Ethernet Interface “RNDIS”
 2. A generic virtual COM port driver “Serial USB device”. If you have several COM ports installed in the host PC, you may want to note the COM Port number under which the unit got installed.
 3. A Virtual Storage device (similar to an USB Stick) that contains resources such as manual and programming devices as well as drivers for Windows 7.

Both virtual COM and Ethernet Ports can be used to remote control the unit. The installed COM Port number can be retrieved from Windows device manager.

To access the WebGUI, the USB virtual Ethernet IP address is needed. If the DNS configuration of your computer allows, the IP address can also be retrieved by entering the command shell “ping corx.local” or retrieve it from the label located at the rear of the unit.

The virtual COM Port and the virtual Ethernet interface are concurrent ways to access the unit for remote control. The web-based control can be accessed via entering http://corx.local/ into the address field of your Web Browser.

5.2.1.1 WINDOWS 10 OR LATER

Windows 10 will automatically install 3 devices allowing to connect the unit

5.2.1.2 WINDOWS 7

Windows 7 will install the same structure as described in the windows 10 section above. It will automatically install a virtual Ethernet interface (RNDIS) and the USB storage device (“Linux File- Store Gadget USB Device”). However, it does not have a preconfigured driver setup for the virtual COM Port. It will try to locate a driver for the unit on the host PC first and then check online. Stop the search and select the option “Install a custom driver”. Point the installation routine to the driver located on the USB storage device provided by the unit in directory “USBDriverWin7” and select file “CORXUSBSerialDriverWindows7.inf” in this folder. If the installation has been completed already, open Windows Device Manager, locate “CDC Serial”, right click on it and select “Update driver”. Proceed as described before.

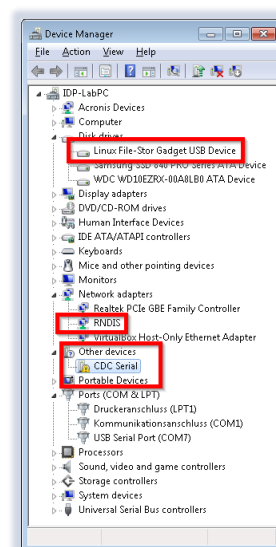
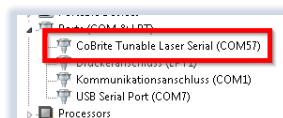

Continue with the installation routine. Once installed, the virtual serial/COM port should appear in Windows Device Manager as shown below. The serial/COM Port number will be different for your system. Note down the number for later usage in remote control applications.

5.2.1.3 CONNECTION TO THE DEVICE VIA USB VIA HOST PC

Once installed properly, the USB connection provides a virtual serial/COM Port and a virtual Ethernet Port to the instrument. To access the unit via virtual Ethernet, follow the instructions as in section 5.1 but note that the IP Address of the unit will be different as for the physical Ethernet Port and cannot be changed as it is assigned by the Windows host PC upon installation.

To access to the unit using the virtual COM port, open a terminal window using the installed COM port number per description above.

5.3 INSTALLATION OF CONTROL SOFTWARE

This instrument does not require any installation of software for operation and control. Once the unit is connected to a host PC or a local network, simply enter `http://corx.local/` into the address field of your Web browser to access the unit.

5.4 WHAT IF “CORX.LOCAL” CANNOT BE REACHED BY HOST COMPUTER OR THE IP ADDRESS IS UNKNOWN?

Depending on the configuration of your host PC DNS structure, the `http://corx.local/` address might not be resolved into the correct IP address of the device.

If the default IP address of the device is still on factory default, it is “192.168.0.1”. Configure the Ethernet address of the host PC to 192.168.0.2. Make sure to disable to disconnect other Ethernet interfaces on this PC to avoid potential interference. Connect the Ethernet cable to the host PC and the unit. LEDs next to the Ethernet should become green. Enter “192.168.0.1” into your Browser on the Host PC.

5.4.1.1 FACTORY DEFAULT ETHERNET IP ADDRESS

The factory default Ethernet IP Address is 192.168.0.1.

5.4.1.2 RETRIEVAL OF IP ADDRESSES USING USB CONNECTION

Open a connection to the USB virtual serial interface (COM Port) by a terminal tool such as Putty which is provided on the installation medium of this unit.

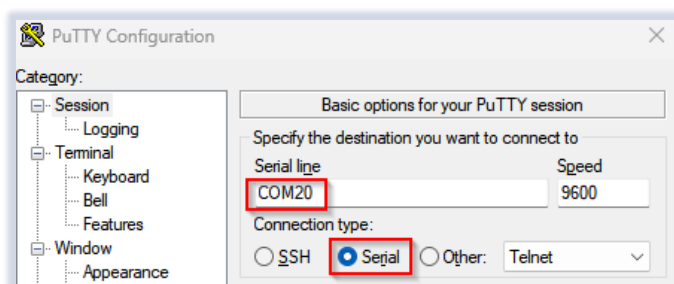

The COM port number can be retrieved from the Windows Device Manager (<Windows Key> + X) in section Ports (COM & LPT).

5.4.1.2.1 USB IP ADDRESS

Open the connection and type the command `“USBIPADDR? ;”`. Press <ENTER> to retrieve the USB IP Address. Alternatively, look up the USB IP Address from the type label located at the rear of the unit. Enter this IP Address into your Browser address field to access the WebGUI.



5.4.1.2.2 ETHERNET IP ADDRESS

To retrieve the current IP address of the Ethernet interface, type “IPADDR?;”. Press <ENTER> to retrieve the Ethernet IP address.

After retrieving the address, enter the corresponding IP address into your system Web Browser address field to access WebGUI the unit.

6 REMOTE CONTROL

This device operates using SCPI standard style commands which are ASCII based and allow easy communication and interpretation with the instrument. Refer to chapter “Board and Connector description” on how to establish communication to the ports available at the instrument. More detailed information on SCPI syntax can be found here: <http://www.ivifoundation.org/docs/SCPI-99.PDF>

6.1 OPERATING MULTIPLE INTERFACE PORTS

This unit supports parallel usage of all remote-control ports available. Note that responses to commands issued are only returned to the according interface from where the command was issued.

Commands are generally executed in order of time wise arrival to the controller and buffered into an Event queue. If a stack overflow occurs, an error is issued.

Note that there is no control exclusivity for a specific interface or user. Thus, parallel commands issued by different instances will be might lead to inconsistencies. It is therefore recommended to poll current parameter status to ensure integrity of set vs. actual parameters and query the operation complete register (“*opc?”) to make sure all previous commands have been executed or applied to the laser control. Note that it is recommend to use the query “busy?” to determine if a laser port is still tuning as the “*opc?” query will only tell if the corresponding change of configuration has been triggered but might not be completed.

It is possible to lock out other remote sessions to avoid changes by using the remote lock command. For details, see section 6.8.

6.2 QUERY CONNECTION TYPES

Connections to remote control the unit via SCPI can be made either by using telnet protocol on port 2000 or HTTP queries. While for performance reasons, telnet-based access should be preferred, HTTP based access can be used in installations where Port 2000 is blocked by Network firewalls or routers since HTTP uses Port 80 which is open in most networks.

6.2.1 TELNET BASED

Connections made with the device can be session based by a raw terminal connection (see 0) using Port 2000 for Ethernet or a COM Port session (5.2.1.3).

Connections through HTTP Service (Port 80). In this case, the SCPI command is encapsulated in the following http request:

```
http://<CORX IP>/scpi/<SCPI-Command>
```

6.2.2 HTTP BASED

Example: `http://corx.local/scpi/*idn?` queries the identification string of the unit. For a quick test, simply copy this query into the browser address field.

The ASCII encoded response is identical to the session-based response.

<wsp> characters defined in the SCPI definitions are to be replaced with ASCII string “%20” per HTML code standard requirements. No termination character “;” or <CR> is needed for HTTP based access.

Multiple commands can be sent within a single query by means of separation via the termination character “;”



Example: `http://corx.local/scpi/*idn?;lay?`

Note that this connection type is not session based like the terminal connection. So, each query sent will establish a new session which is terminated after the query response is given. Consequently, commands requiring elevated user rights will require to send the password with the actual query in the same request.

Example: `http://corx.local/scpi/pass%20IDP;pass?`

will send the password "IDP" to the unit to elevate the user level.

6.3 SYNTAX CONVENTIONS FOR COMMANDS

6.3.1 LONG AND SHORT FORM

The key words feature a long form and a short form. Either the short form or the long form can be entered in one command, other abbreviations are not permissible.

Example: `":SYStem:IPADDRess?"` is equal to `"IPADDR?"`

! NOTE

The short form is marked by upper-case letters; the long form corresponds to the full expression. Upper-case and lower-case notation only serve the above purpose, the instrument itself accept both upper-case and lowercase letters.

! NOTE

All commands are case insensitive. Long and short form may not be mixed within a single command.

6.3.2 QUERY COMMANDS

Most commands serve a double function that allows either setting or executing a query on a parameter.

! NOTE

Query commands are terminated by a "?" character.

6.3.3 PARAMETER

Parameters must be separated from the header by a "white space". If several parameters are specified in a command they are separated by a comma ",".

6.3.4 COLON CHARACTER

A leading colon character ":" instructs the instrument to interpret the command starting at the root (highest level) of the command tree. Since the Instrument also starts at the root each time you send it a new command, the leading colon is not required (although the instrument will accept it if you send it).

6.3.5 COMMAND TERMINATION CHARACTER FOR TELNET AND SERIAL COMMUNICATION

Each command must be terminated either by a ";" = 0x3B character or a line feed <LF> = 0x0A to signal completion of the command telegram to the controller. Depending on settings of the connection, the host buffer is only sent to the unit if a <LF> is used. Therefore, it is recommended using <LF> for sending commands. The response termination is always "; <LF>" = 0x3B0A. In this documentation, the <LF> is not shown to enhance readability.

! NOTE

Sending two termination characters is a common mistake causing the unit to respond with "ERR 100;<LF>" since the first command is executed once the first termination character is received and the second termination character causes the unit to interpret an empty command. Example:

Command: `"wav 1550;<LF>"`



Response “;<CR>ERR 100, unknown command; <LF>”

The unit will set wavelength 1550nm to the laser but additionally receives the empty command which causes the error response.

6.3.6 ACKNOWLEDGEMENT OF EXECUTED COMMANDS

The mainframe controller will always acknowledge successful execution of commands by a “;<LF>” character. If the echo option is set (for details, see command list), the accordingly sent command is returned first.

6.3.7 COMMUNICATION EXAMPLE

Host sends: *idn?;

unit response: CO-RX-C60-10-FA, SN 19160001, F/W Ver 1.0.0(101), HW Ver 1.00;

6.3.8 BASIC SCRIPT EXAMPLE

The following commands can be a minimal script to perform a basic set up of the unit and read the data

COMMAND	COMMENT
INTI;	Initialize Communication settings
*IDN?;	Query idn string of unit
PASS IDP	Raise user level to 1
DEFAULT;	Sets unit settings to factory default
WAV 1550;	Sets Laser Wavelength to 1550nm
pow 14;	Sets output Power of laser 1-1-1 to 14 dBm
stat 1;	Enables Laser 1-1-1 output
*opc?;	Queries if command has been executed (status 1).
busy?;	Queries if the laser port has finished tuning and has settled on target settings that were set before
bwai *,*,*;	Unit will acknowledge once all laser ports have finished tuning.

Screenshot of script example result:

```

192.168.0.1 - PuTTY
INTI
;
*IDN?
COBRITE CBDX2-SC-NC-FA, SN 20300008, F/W Ver 1.1.2(126), HW Ver 1.10;
PASS IDP
;
DEFAULT
;
WAV 1550
;
pow 14
;
stat 1
;
*opc?
1;
busy?
0;
bwai *,*,*
;

```

<ENTER> was used to execute the command. Alternatively, use “;”. If both is used, it is interpreted as 2 commands of which the second one is empty so that the first command is executed but the second produces an error since empty.

```

192.16...
*OPC?
l;
*opc?;
l;
ERR 100, unknown command;

```

6.4 USER ACCESS LEVEL

This feature allows execution of commands protected in standard access level to avoid accidental change of important parameters. See command description “[:SYStem:]PASSword” for details on how to enable enhanced access.



Custom passwords can be set to the unit for enhanced security requirements. See details in description for “[:SYStem:] SetPASS<wsp>, <P>, <P>”.

Note: User access level is granted session based. Each time, a new remote connection is made; the standard User access level 0 is set per default.

USER ACCESS LEVEL	PASSWORD
0	-
1	IDP

6.5 NOTATION OF SYNTAX FOR COMMAND DEFINITION

SYNTAX AND TYPE	DESCRIPTION
[]	Optional command level that can be omitted. Example: Definition [:SYStem:]IPADDRess/? /<P> Allows sending the command: IDADDR?
< >	Denotes a parameter. Placeholder is replaced with parameter value defined for according command. Definition [:SYStem:]IPADDRess/? /<P> Allows setting the parameters: [:SYStem:]IPADDRess 192.168.0.1
/?	Denotes the optional character “?” that is used if the command can also be used as a query. Example: Definition [:SYStem:]IPADDRess/? /<P> “?” is used to query current IP Address of the device: IPADDR?;
/<wsp><P>	Denotes an optional parameter value preceded by a white space character.
:, *	Usage of Colon see 6.3.4
<wsp>	Denominates a white space character
<INT>	Integer value
<REAL>	Real value

6.6 NOTATION OF CHANNEL NUMBER IN SCPI

CHANNEL #	CHANNEL DESCRIPTION
1	XI
2	XQ
3	YI
4	YQ

6.7 GENERAL SCPI COMMANDS

SYNTAX	EXAMPLE	DESCRIPTION
*idn?	*idn?; CO-RX-C60-10-FA, SN 19160001, F/W Ver 1.0.0(101), HW Ver 1.00;	Query System Type and Software version. The remaining string is determined by the laser configuration of the actual device. It matches the part number that is printed on the label on the unit.



*opc?	*opc? 1;"	Query if all pending commands were executed. Note that this will NOT indicate if physical tuning of laser ports has been completed. Use busy? Query for this.
*rst	*rst;	Reset Controller; will warm start the instrument. All connections/sessions will be closed. Requires user level 1
*WAIt	*WAI; ;	Unit waits with response until *opc? is 1 and then acknowledge command. This eliminates need for polling loop of *opc? on remote side
*CLS	*CLS; ;	Clears all status/alarm registers of the unit. This command is used to clear latched alarm registers.

6.8 COMMANDS ON SYSTEM LEVEL

SYNTAX	READ WRITE	USER ACCESS LEVEL	PARAMETE R FORMAT	DESCRIPTION
[:SYStem:]ECHO/?/<wsp><P>	RW	0	"0" or "1"	Sets or query echo command sent status, this setting applies to current session only
[:SYStem:]DEFAULT	W	1	-	Resets user settings such as laser settings to factory default. This affects all settings including trigger configuration except Remote interface settings.
[:SYStem:]StArtDEFAult /?/<wsp><P>	RW	1	"0" or "1"	Queries/Sets if unit starts with last settings set before a reboot or with default of device. This affects all settings except Remote interface settings and Laser Port on/off status. 0 = Save each change of setting and restart with current config upon next reboot 1 = Always start with unit factory defaults
[:SYStem:]REMOte?	R	0	"0" or "1"	Query remote status of device. Any open remote sessions via Ethernet?
[:SYStem:]PASSword/?/<wsp><P>	RW	0	ASCII	Set new User level status by sending password or query current User level status
[:SYStem:]TIME?/<wsp><P>	R/(W)	0	xxxxxxxx	Query or set system time. Note that time is set and tracked in volatile memory only. It requires to be set after each cold start.
[:SYStem:]ALARm?	R	0	<INT>	Query alarm status of device, see Alarm code definition 6.13 for details.
[:SYStem:]ERRor[:NEXT]?	R		-	Queries data in an error queue and deletes it from the queue.
[:SYStem:COMMunicate:]LOCKout/?	RW	1	"0" or "1"	Locks other sessions to perform write commands on the unit. It is automatically released if the active session closes



SYNTAX	READ WRITE	USER ACCESS LEVEL	PARAMETE R FORMAT	DESCRIPTION
[:SYSTem:COMMunicat e:]ParameterREFresh ?	R	0	<INT>	This query allows detecting if any change to the configuration was done. Each time the counter increases, the configuration was changed. This is useful in multi-user environments to detect if a parallel session has changed settings on the unit
[:]ABORT	W	0	-	Aborts all currently executed pending commands as fast as possible. Query *OPC? To determine status once all pending commands are aborted
[:BOOT:]BootLoaDerR ESet	W	0	-	Resets upload procedure for firmware upgrade. All data uploaded already is erased. New process can be restarted
[:BOOT:] BootLoaDerAPPend	W	0	binary	send portions of the binary Firmware Image, each Byte is coded into 2 Characters 1..F, send max. 100 Bytes per command
[:BOOT:]BootLoaDerE XECute/?	RW	0	-	Set: Executes upgrade of previously uploaded Firmware image. Query responds with current status of execution.
[:SYSTem:]ENableLOG ging/?	RW	R 0 W 1	"0" or "1"	This command enables local logging in the unit that can be used for debugging purposes. Enable this only if a persistent issue exists and ID Photonics asked you to enable the feature since this can slow down the performance of the instrument. The trace file read via RDEBUG is encrypted and cannot be checked by the user.
[:SYSTem:]ReadDEBUG	R	0	-	Collects debug information from OSA which can be sent to ID Photonics for troubleshooting. Returns a maximum of 1000bytes per read. Responds "WAIT" as long as debug data is still collected. Responds "EOL" if all data is read.
[:SYSTem:]IDENTify< wsp><P>	W	0	"0" or "1"	En- or disables blinking of the on the unit allowing identification of the unit attached to remote control.
[:SYSTem:]INTLock?	R	0	"0" or "1"	Query the status of the interlock setting. Optical output of lasers can only be enabled if the interlock jumper is set. 0: Laser can be activated



SYNTAX	READ WRITE	USER ACCESS LEVEL	PARAMETE R FORMAT	DESCRIPTION
:SYStem:RESet	W	1	-	Will reset instrument. Same as command *rst, see details in description of *rst
[:SYStem:]SetPASS<wsp><P>	W	'-	-	Sets a password to access the current user level. Requires current user level to be at the level that password is to be set. Parameter is a string defining the password.
[:SCRIPting:]WAITMi lliSeconds	W	1	<INT>	This command causes the unit to wait for specified time until the next command in buffer is executed. This is helpful if a batch of commands is uploaded to the unit for execution. Requires Firmware Version 1.2.1 or later

6.9 COMMUNICATION PORT SETTINGS

SYNTAX	READ WRITE	USER ACCESS LEVEL	PARAMETER FORMAT	DESCRIPTION
[:SYStem:]DHCP/?/<wsp><P>	RW	1	"off" or "on"	configure DHCP Setting for Ethernet interface.
[:SYStem:]USBIPADDR ess?	R	0	xxx.xxx.xxx.xxx	IP Address of virtual Ethernet interface on USB
[:SYStem:]USBNETMAS K?	R	0	xxx.xxx.xxx.xxx	Netmask Setting of virtual Ethernet interface on USB
[:SYStem:]IPConfigD EFAult	W	1	-	Resets all settings of remote interfaces to factory defaults. This becomes effective only after a reboot of the unit.
[:SYStem:]INTErface Init	W	0	-	Reset session parameters to defaults. Call this after opening the remote port. This command resets ECHO, PASS, FORMAT, UNIT:X, LINLOG, EVENT.
[:SYStem:]IPADDRess /?/<wsp><P>	RW	1	xxx.xxx.xxx.xxx	IP Address Setting of Ethernet interface
[:SYStem:]NETMASK/? /<wsp><P>	RW	1	xxx.xxx.xxx.xxx	Netmask Setting of Ethernet interface
[:SYStem:]GATEWAYIP /?/<wsp><P>	RW	1	xxx.xxx.xxx.xxx	IP address for Gateway of Ethernet interface
[:SYStem:]MACADDR ESS?	R	0	XX:XX:XX:XX:XX: XX	Reads MAC Address of physical Ethernet interface.



SYNTAX	READ WRITE	USER ACCESS LEVEL	PARAMETER FORMAT	DESCRIPTION
[:SYStem:] IPConfCHanged?	R	0	0 1	Check if IP configuration of the Ethernet Interface was changed but no reboot was triggered yet to activate the new settings. This can be used to determine if the actual settings differ from the settings that will be active upon restart.

6.10 RECEIVER COMMANDS

Queries sent without channel parameter will return value for all channels.

Example:

PDCURRENT? Will query the current of all 4 Photodiodes

PDCURRENT? 2 Will query the current Photodiodes #2 (XQ)

SYNTAX	READ WRITE	USER ACCESS LEVEL	PARAMETER FORMAT	DESCRIPTION
[:RX:] TIAONOFF/?<wsp>/<P>/, /<P>	RW	1	1; 0	Switches the output of the Transimpedance amplifiers (TIAs) on or off
[:RX:] PDCURRENT?<wsp>/<P>	R	0	-	Reads Currents of Receiver Photodiode in [uA]
[:RX:] ATTenuation/?<wsp>/<P>	RW	0	<INT>	Query or sets the VOA setting. Parameter can vary between 0 und 100%
[:RX:] OPOWer?	R	0	<REAL>	Query optical Power at Monitor of port "Optical Signal" in [dBm]
[:RX:] AutoGAIN/?<wsp>/<P>	RW	0	1; 0	Query or set Automatic Gain (1) or Manual Gain (0)
[:RX:] AMPLEVel/?<wsp>/<P>/, /<P>	RW	0	<REAL>	Query or set Amplitude level at RF output in Automatic Gain Mode from 0 to 100%
[:RX:] GAINLEVel/?<wsp>/<P>/, /<P>	RW	0	<REAL>	Query or set Amplitude level at RF output in Constant Gain Mode from 0 to 100%
[:RX:] PEAKINDicator /?<wsp>/<P>	R	0	<REAL>	Query the Peak Indicator Monitor reading 0 to 100%
[:RX:] PEAKING/?<wsp>/<P>	RW	0	<REAL>	Set or query the peaking level of the TIAs. Depending on model, the Peaking level can be set to {0}, {0, 1}, {0, 1, 2, 3}



6.11 LASER PORT COMMANDS

COMMAND	TYPE
[:SOURce:]WAVelength/?/<wsp>/<P>	<REAL>nm
Sets or queries the wavelength setting of a tunable laser port. Value format is in Nanometer. Example: WAV 1550.012; sets Laser to 1550.012nm	
[:SOURce:]WAVelength:LIMit?	<REAL>nm
Queries the wavelength setting limits of a tunable laser port. Value format is in Nanometer. Example: WAV:LIM?; queries Laser Response with min and maximum limit: 1528, 1565;	
[:SOURce:]FREQuency/?/<wsp>/<P>	<REAL>THz
Sets or queries the wavelength setting of a tunable laser port. Value format is in Tera Hertz. Example: FREQ 192.15; sets Laser to 192.15THz.	
[:SOURce:]FREQuency:LIMit?	<REAL>THz
Queries the frequency setting limits of a tunable laser port. Value format is in Tera Hertz. Example: FREQ:LIM?; queries Laser. 2 value Response with min and maximum limit: 191.1020, 196.1020;	
[:SOURce:]OFFset/?/<wsp>/<P>	<REAL>GHz
Sets or queries the frequency offset setting of a tunable laser port. Value format is in Giga Hertz. Example: OFF 11.15; sets Laser offset to 11.15 GHz. Value can be positive or negative.	
[:SOURce:]OFFset:LIMit?	<REAL>GHz
Queries the offset setting limits of a tunable laser port. Value format is in Giga Hertz. Example: OFF:LIM?; queries Laser Response 12; It is a single value since the offset is symmetrical to 0.	
[:SOURce:]POWer/?/<wsp>/<P>	<REAL>dBm
Sets or queries the optical output power target setting of a tunable laser port. Value format is in dBm. Example: POW 11.15; sets Laser power of 11.15dBm	
[:SOURce:]ActualPOWer?	<REAL>dBm
Queries the current optical output power reading of a tunable laser port. Value format is in dBm. Example: APOW?; 11.15; queries the Laser answer is 11.15dBm	
[:SOURce:]LIMit?	<REAL>
Query maximum tuning Parameters of Laser in location C-S-D in csv format. <Minimum Frequency>,<Maximum Frequency>,<Fine tuning Range>,<Minimum Power>,<Maximum Power> Example: LIM?; queries Laser	
[:SOURce:]CONFIguration/?/<wsp>/<P>	<REAL>
Set or Query current configuration of Laser in location C-S-D in csv format: <Frequency>,<Offset>,<Output Power>,<Output state>,<Busy state>,< Dither state>, Busy state : <INT> "1","0", Only for query, if set is used, this parameter is omitted Dither state: <INT> "1","0","-1" If queried and "-1" is reported, laser does not support this feature. If set and laser does not support the feature, the parameter setting must be "-1". Example read: SOUR:CONF? 1,1,1; returns 191.42,10.134,6.12,0,1,-1; The laser is set to 191.42THz, 10.134GHz FTF, 6.12dBm, output on (1) , not busy tuning (0), dither not supported(-1)	



COMMAND	TYPE
<p>Example write: SOUR:CONF 1,1,1,193,1,7,1,-1; will set the to 193THz, Fine tuning 1GHz, 7dBm output power, 1: laser on, 1: dither not supported.</p> <p>Note: For SC Type lasers, Frequency and offset cannot be changed within a single command. Use 2 commands to set them separately.</p>	
[:SOURce:]BUSY?	<INT>
Query if laser port is currently tuned "1" or settled "0".	
[:SOURce:]STATe/ ? /<wsp> /<P>	<INT>
Query if laser is on "1" or off "0"	
[:SOURce:]MONitor?	<REAL>
<p>Query monitor readings from laser. Response: <LD chip Temperature>, format nn.nn, unit °C <LD base Temperature>, format nnnn.n, unit mA <LD chip current>, format nnnn.n, unit mA <TEC current>, format nnnn.n, unit mA</p> <p>Example: MON? 1,2,3; Returns 29.23, 25.12, 125.1, 1043.2</p>	
[:SOURce:]BusyWAIT	-
<p>Unit will acknowledge once selected laser ports have finished tuning. Use this to avoid polling busy status in while loop. Needs response timeout on host side > tuning time of laser (we recommend 20s). Use wild card to query for multiple ports.</p> <p>Example: bwai 1,2,3; Returns ; after laser has finished tuning</p> <p>bwai *,*,*; Returns ; after laser have finished tuning</p> <p>bwai; Returns ; after laser has finished tuning</p>	

6.11.1 COMMAND PROPERTY OVERVIEW

6.11.1.1 SYSTEM LEVEL COMMANDS

Session based parameters/commands will be initialized to default each time a new connection/session is opened to the instrument.

SYNTAX	READ WRITE	USER ACCESS LEVEL	SESSION BASED	DEFAULT VALUE	STORED IF STADEF =0
[:SYStem:]ECHO/ ? /<wsp><P>	RW	0	X	0	-
[:SYStem:]STArtDEFault / ? /<wsp><P>	RW	1	-	1	-
[:SYStem:]DEFAUlt	W		-	-	-
[:SYStem:]INFORmation?	R	0	-	-	-
[:SYStem:]DHCP/ ? /<wsp><P>	RW	1	-	OFF	-
[:SYStem:]IPADDRess/ ? /<wsp><P>	RW	1	-	192.168.0.1	-
[:SYStem:]NETMAsK/ ? /<wsp><P>	RW	1	-	255.255.255.0	-
[:SYStem:]GATEWAYIP/ ? /<wsp><P>	RW	1	-	192.168.0.255	-
[:SYStem:]IPADDRess1/ ? /<wsp><P>	RW	1	-	192.168.0.1	-



SYNTAX	READ WRITE	USER ACCESS LEVEL	SESSION BASED	DEFAULT VALUE	STORED IF STADEF =0
[:SYStem:]NETMASK1/?/<wsp><P>	RW	1	-	255.255.255.0	-
[:SYStem:]GATEWAYIP1/?/<wsp><P>	RW	1	-	192.168.0.255	-
[:SYStem:]IPADDEss2/?/<wsp><P>	RW	1	-	192.168.0.1	-
[:SYStem:]NETMASK2/?/<wsp><P>	RW	1	-	255.255.255.0	-
[:SYStem:]GATEWAYIP2/?/<wsp><P>	RW	1	-	192.168.0.255	-
[:SYStem:]MACADDRESS?	R	0	-	-	-
[:SYStem:]IPConfigDEFault	W	1	-	-	-
[:SYStem:]INTErfaceInit	W	0	-	-	-
[:SYStem:]REMOte?	R	0	-	-	-
[:SYStem:]PASSword/?/<wsp><P>	RW	0	X	-	-
[:SYStem:]TIME? /<wsp><P>	R/(W)	0	-	-	-
[:SYStem:]ALARm?	R	0	-	-	-
[:SYStem:]STATus?	R	0	-	-	-
[:SYStem:]ERRor[:NEXT]?	R		-	-	-
[:SYStem:COMMunicate:]LOCKout/?	RW	1	-	0	-
[:SYStem:COMMunicate:]Paramete rREFresh?	R	0	-	0	-
[:STATus:OPERation:]EVENT?	R	0	-	-	-
[:]ABORT	W	0	-	-	-
[:BOOT:]BootLoaDerRESet	W	0	-	-	-
[:BOOT:] BootLoaDerAPPend	W	0	-	-	-
[:BOOT:]BootLoaDerEXECute/?	RW	0	-	-	-
[:SYStem:]ENableLOGging/?	RW	1	-	0	-
[:SYStem:]ReadDEBUG	R	0	-	-	-
[:SYStem:]IDENTify<wsp><P>	W	0	-	0	-
[:SYStem:]ENABLEAUTOSTart/?/<w sp><P>	RW	1	-	0	-
[:SYStem:]STArtDEFault /?/<wsp><P>	RW	1	-	1	-
[:SYStem:]SetPASS<wsp>,<P>,<P>	W	-	-	1	-



6.11.1.2

LASER PORT COMMANDS

COMMAND	READ WRITE	USER ACCESS LEVEL	STORED IF STADEF =0
[:SOURce:]WAVelength/?/<wsp>/<P>	RW	0	✓
[:SOURce:]WAVelength:LIMit?	R	0	-
[:SOURce:]FREQuency/?/<wsp>/<P>	RW	0	✓
[:SOURce:]FREQuency:LIMit	R	0	-
[:SOURce:]OFFset/?/<wsp>/<P>	RW	0	✓
[:SOURce:]OFFset:LIMit?	R	0	-
[:SOURce:]POWer/?/<wsp>/<P>	RW	0	✓
[:SOURce:]ActualPOWer?	R	0	-
[:SOURce:]POWer:LIMit?	R	0	-
[:SOURce:]LIMit? >	R	0	-
[:SOURce:]CONFIguration/?/<wsp>/<P>	RW	0	✓
[:SOURce:]BUSY?	R	0	-
[:SOURce:]STATe/?/<wsp>/<P>	RW	0	✓
[:SOURce:]MONitor?	R	0	-
[:SOURce:]LaserALARm?	R	0	-
[:SOURce:]BusyWAIT	R	0	-

6.12 SCPI CODE ERROR DEFINITION

ERROR #	DESCRIPTION
100	Command Syntax Command error
101	Parameter out of range
102	No data in buffer
103	device not ready
104	user level for this command not sufficient
200	Command execution error
201	user level rights to execute this command not sufficient, increase using PASS command
250	
251	
252	

6.13 ALARM CODE DEFINITION

The following table details potential alarms raised by the unit. The alarm status can be queried using the “alar?” command. The response is an ASCII coded unsigned 16-bit integer number, little endian. Convert this number into binary format to retrieve the alarm status. Each “1” bit represents an active alarm.

Note that the alarm register is latched. So, any alarm, is monitored since either boot of unit or last *cls command. In order to determine if an alarm is currently present, send an *cls command before query. Use the SCPI Command “*cls” to clear all latched alarms.



BIT #	ALARM	CONDITION/DESCRIPTION
0	Input Power High	Optical Input power at port "Signal In" is higher than allowed limit. This may damage the receiver. Immediately switch of the signal!
1	Input Power Low	Optical Input power at port "Signal In" is below a detectable limit. Slowly increase power. Beware optical power transients (sudden increase of optical power) as they may damage the receiver.
2	Laser temperature too high	Base temperature of one or more laser ports exceeds max. threshold. Laser is de-activated to protect Hardware.
3	Interlock while laser was ON	Interlock safety switch was opened while at least one laser port was enabled causing the laser port to be switched off according to safety rules.
4	Controller communication Failure	Main Controller cannot communicate with other internal components of the unit.
5	Laser error	The internal laser reports an error. Download service log and provide it to ID Photonics
6	Power supply error	The internal power supply monitoring reports an error. Download service log and provide it to ID Photonics
7	Not used	
8	Not used	
9	Not used	
10	Not used	
11	Not used	
12	Not used	
13	Not used	
14	Not used	
15	Not used	

The logo for IDPHOTONICS GMBH, featuring the company name in a blue, sans-serif font. The 'O' in 'PHOTONICS' is stylized with a circular arrow around it. A small 'GMBH' is positioned to the right of the main text.

IDPHOTONICS^{GMBH}

SHAPING LIGHT.

HELPING ENGINEERS AND
SCIENTISTS IN
ADVANCING HOW THE
WORLD COMMUNICATES,
SENSES AND CONNECTS



TUNABLE
LASER



TRANSMITTER
SOLUTIONS

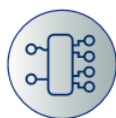

RECEIVER
SOLUTIONS



SPECTRAL
ANALYSIS



Anton-Bruckner-Strasse 6
85579 Neubiberg
GERMANY
Tel: +49-89-201 899 16
info@id-photonics.com
id-photonics.com

All rights reserved. No part of this publication may be reproduced, stored in a retrieval system or transmitted in any form, be it electronically, mechanically, or by any other means such as photocopying, recording or otherwise, without the prior written permission of ID Photonics GmbH. Information provided by ID Photonics GmbH is believed to be accurate and reliable. However, no responsibility is assumed by ID Photonics GmbH for its use nor for any infringements of patents or other rights of third parties that may result from its use. No license is granted by implication or otherwise under any patent rights of ID Photonics GmbH. The information contained in this publication is subject to change without notice.