



## ID OSA OPTICAL SPECTRUM ANALYZER

### USER MANUAL



**Applicable Part Numbers** ID-OSA-MPD-x1, x: Wild Card

Status: 2024-12-16  
Applies to Firmware 2.1.0 or later

info@id-photonics.com  
id-photonics.com

# CONTENT

1	General Information	3
2	Unit Overview - Operating principle and block diagram	6
3	Quick start	8
4	Getting Started	9
5	Graphical User Interface – Web interface (WebGUI)	13
6	General Concepts of the ID OSA	19
7	Remote Control	23
8	Uninstalling GUI Software	41

# 1 GENERAL INFORMATION

## 1.1 COMPLIANCE STATEMENT ELECTROMAGNETIC COMPATIBILITY AND DEVICE SAFETY

Hereby, we declare that this system has been designed and tested for compliance for the following directives.

### 1.1.1 INTERNATIONAL

IEC 62368-1

CISPR 11:2003 in accordance with EN 61326-1: 2006

### 1.1.2 UNITED STATES OF AMERICA

FCC 47 CFR Part 15, Subpart B Class A, Measurement process ANSI C63.4 (2009)

### 1.1.3 EUROPEAN UNION

EN 55022:2011

EN 61326-1: 2013

EN 61000-6-2: 2006

EN 61000-6-4: 2011

EN 61000-3-2: 2010

EN 61000-3-3: 2009

This conformity statement for includes EU directive 2002/95/EG (RoHS) and EU directive EG1907/2006 (REACH).

## 1.2 LIMITATION OF COMMUNICATION INTERFACES

Operation of all USB Ports is limited to a maximum cable length of 3m and a maximum length of 30m for all Ethernet ports present.

## 1.3 EUROPEAN WEEE DIRECTIVE COMPLIANCE

ID PHOTONICS has established processes in compliance with the Waste Electrical and Electronic Equipment (WEEE) Directive, 2002/96/EC. This product should not be disposed of as unsorted municipal waste and should be collected separately and disposed of according to your national regulations. In the European Union, all equipment purchased from ID PHOTONICS can be returned for disposal at the end of its useful life. ID PHOTONICS will ensure that all waste equipment returned is reused, recycled, or disposed of in an environmentally friendly manner, and in compliance with all applicable national and international waste legislation. It is the responsibility of the equipment owner to return the equipment to ID PHOTONICS for appropriate disposal. If the equipment was imported by a reseller whose name or logo is marked on the equipment, then the owner should return the equipment directly to the reseller. If you have questions concerning disposal of your equipment, contact ID PHOTONICS's at [WEEE@id-photonics.com](mailto:WEEE@id-photonics.com).

## 1.4 LINE VOLTAGE SELECTION

CoBrite DX and CoBrite MX chassis operate from any single-phase AC power source that supplies 100 ~ 240VAC at a frequency at 50/60 Hz. The input line voltage setting is done automatically by CoBrite power supply. The CoBriteDX2 device itself does not have an integrated AC power supply but uses an external AC/DC supply that provides 12VDC to the chassis. This external supply operates from any single-phase AC power source that supplies 100 ~ 240VAC at a frequency at 50/60 Hz. The input line voltage setting is done automatically by the external power supply. Do only use the provided power supply to power the device.

## 1.5 SERVICE

Do not attempt to service or adjust this instrument unless an authorized person is present. Do not install substitute parts or perform any unauthorized modifications to this instrument. Contact ID Photonics or your local distributor to obtain service support.

## 1.6 HELP AND USER FEEDBACK

ID Photonics GmbH is dedicated to continuously improve customer experience of our products. Thus, if you have any feedback that might help us to improve our products send us an E-Mail to: [feedback@id-photonics.com](mailto:feedback@id-photonics.com)

## 1.7 SAFETY

### 1.7.1 GENERAL SAFETY PRECAUTIONS

The following general safety precautions must be observed during all phases of operation of this instrument. Failure to comply with these precautions or with specific warnings elsewhere in this manual violates safety standards of design, manufacture, and intended use of the instrument.

#### NOTE

ID Photonics assumes no liability for the customer's failure to comply with these requirements

Before operation, review the instrument and manual for safety markings and instructions. You must follow these to ensure safe operation and to maintain the instrument in safe condition.

### 1.7.2 GENERAL

This product is a Safety Class 1 instrument (provided with a protective earth terminal). The protective features of this product may be impaired if it is used in a manner not specified in the operation instructions.

### 1.7.3 ENVIRONMENT CONDITIONS

This instrument is intended for indoor use in an installation category II, pollution degree 2 environments. It is designed to operate at a maximum relative humidity of 95% and at altitudes of up to 2000 meters. Refer to the specification tables for the ac mains voltage requirements and ambient operating temperature range.

#### NOTE

Before connecting electrical power to the unit, make sure the unit could acclimatize to ambient temperature for at least 2 hours to avoid damage by i. e. condensed humidity on electrical parts inside the unit.

### 1.7.4 BEFORE APPLYING POWER

Verify that all safety precautions are taken. The power cable inlet of the instrument serves as a device to disconnect from the mains in case of hazard. The instrument must be positioned so that the operator can easily access the power cable inlet. When the instrument is rack mounted the rack must be provided with an easily accessible mains switch.

### 1.7.5 FUSE REPLACEMENT

For continued protection against the possibility of fire, replace the fuse only with a fuse of the specified voltage, current and type ratings.

### 1.7.6 GROUND THE INSTRUMENT

The instrument must be connected to the ac power mains through a grounded power cable, with the ground wire firmly connected to an electrical ground (safety ground) at the power outlet. Any interruption of the protective (grounding) conductor or disconnection of the protective earth terminal will cause a potential shock hazard that could result in personal injury.

### 1.7.7 DO NOT OPERATE IN AN EXPLOSIVE ATMOSPHERE

Do not operate the instrument in the presence of flammable gases or fumes.

### 1.7.8 DO NOT REMOVE THE INSTRUMENT COVER

Operating personnel must not remove instrument covers. Component replacement and internal adjustments must be made only by qualified personnel.

Instruments that appear damaged or defective should be made inoperative and secured against unintended operation until they can be repaired by qualified service personnel.

Opening the instrument will result in loss of all warranty given for the instrument and may exhibit lethal health risks.

Keep away from live circuits inside the equipment. Operating personnel must not remove equipment covers. Only factory authorized service personnel or other qualified service personnel may remove equipment covers for internal subassembly or component replacement or any internal adjustment. Do not install substitute parts or perform any unauthorized modification of the equipment or the warranty may be voided.

### 1.7.9 VENTILATION

Keep a space of 30 cm or more between the rear side of the device and any other objects such as walls to guarantee sufficient cooling of the device. Never block the air fan and ventilation openings.

### 1.7.10 CLEANING THE INSTRUMENT

To avoid personal injury, power down the device and disconnect it from line voltage before performing any of the following procedures.

To clean the exterior surface, perform the following steps:

- Remove loose dust on the outside of the instrument with a lint-free cloth.

- Use a soft cloth dampened with water to clean the device. Use 75% isopropyl alcohol solution as a cleaner.

- Do not use any abrasive or chemical cleaning agents.

### 1.7.11 SAFETY SYMBOLS ON INSTRUMENTS

#### 1.7.11.1 WARNING OR CAUTION



If you see this symbol on the product, you must refer to the manuals for specific Warning or Caution information to avoid personal injury or damage to the product.

## 2 UNIT OVERVIEW - OPERATING PRINCIPLE AND BLOCK DIAGRAM

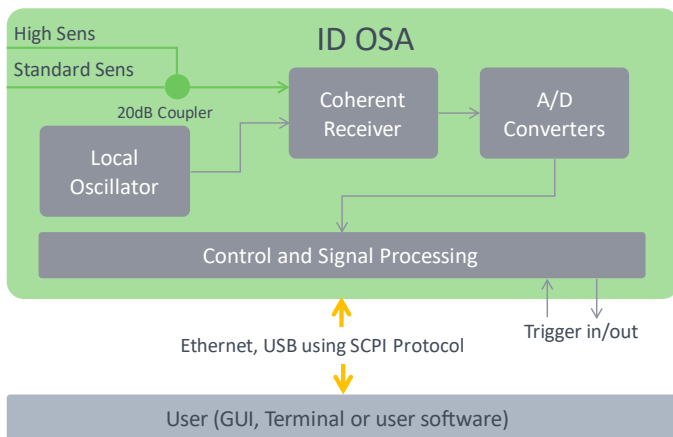

The ID OSA is an optical spectrum analyzer that provides two optical inputs measuring both higher power signal spectra and signals requiring a high sensitivity by means of an integrated coupler across the C Band. The unit automatically corrects the reported power once the user has selected the input currently in use. The unit utilizes a coherent detection scheme to retrieve the optical spectrum of the incoming test signal. This provides a number of unique advantages over traditional grating based OSAs:

- ✓ **High Resolution** - 312.5MHz/2.5pm Scan Resolution
- ✓ **Fast** - 2 Hertz Scan Rate at full Resolution across C Band (15,600 data points)
- ✓ **Compact** - 1HE half size 19" rack stacking
- ✓ **Rugged** - No Moving Optical Parts

A local oscillator together with a coherent receiver provides the necessary mixing terms which are then converted by A/D converters followed by signal processing to extract the optical spectrum data.

User data transfer is provided via a SCPI interface utilizing USB and Ethernet interfaces. The unit supports multiple user connections and multiple user access right level administration. The user interface does not require any specific API Software or similar to be installed on host computers while providing a standardized communication protocol so that any user environment is able to communicate with unit.

The unit provides hardware triggers allowing triggering OSA sweep executions as well as indication of active sweeps.

### 2.1 FRONT SIDE OF UNIT

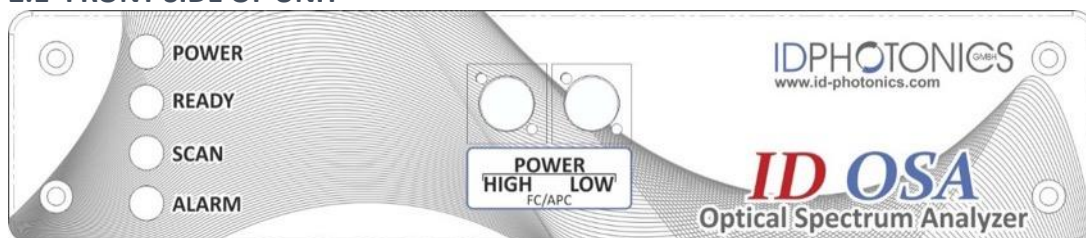

#### 2.1.1 STATUS LEDS

**Power:** This green LED will light up once electrical Power has been supplied to the rear Line in and the switch located next to it is set to 1.

**Ready:** The green Ready LED indicates that the ID OSA Operating System was started and the Optics has reached operating condition.

**Scan:** The green Scan LED indicates an active spectral scan currently in progress. If repeat scan mode is active, the LED will continuously be active as well.

**Alarm:** The red Alarm LED indicates a pending alarm situation. Check in GUI or via remote access about the root cause of the alarm to eliminate it.

### 2.1.2 OPTICAL INPUT PORTS

The ID OSA provides two FC/APC type optical input ports which are coupled together before going to the detection circuit as depicted in the schematic overview of the unit. Use the GUI or remote control to set the port to be used in order to obtain calibrated measurements.

For purpose of cleaning dirty connectors, the 2 Ports are hosted a small daughter plate which are fixed via two screws which can be removed by hand. Gently pull out the assembly after the screws have been removed and disconnect the fiber heads from the FC/APC adaptors.

## 2.2 REAR SIDE OF UNIT

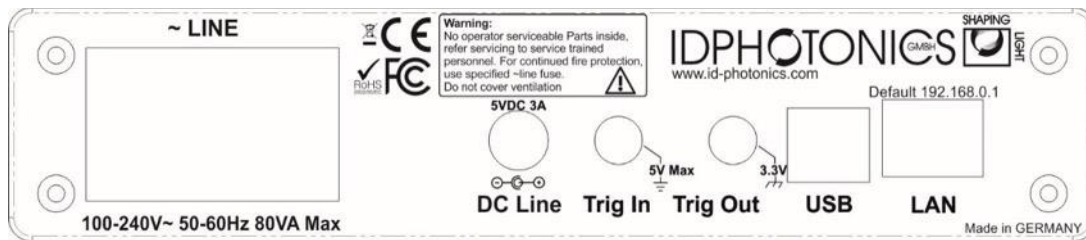

### 2.2.1 POWER SOCKET

#### ! NOTE

Do not use both line ports at the same time in parallel. It may damage hardware.

#### 2.2.1.1 AC LINE

Electrical power can be supplied using a VDE 0625, EN 60 320, C13 type electrical connector. Only use the supplied cable or an identical cable that conforms to the aforementioned standard to connect to the unit. The unit automatically adapts to local power line specifications within the range printed on the unit. There is no reconfiguration needed to switch between the AC and DC line power options.

#### 2.2.1.2 DC LINE

Alternatively, electrical power can be supplied using 5VDC, 3 Ampere DC099 type electrical connector. Make sure to set the polarity of the VDC line on the unit which is printed on the unit near the jacket.

### 2.2.2 TRIGGER PORTS

The SMA type sockets can be used to achieve timewise synchronization of the ID OSA with other equipment. Both ports support 3.3V LV TTL standardized signals.

**Trigger IN** allows triggering OSA scans if the feature is enabled via Remote control or GUI. Polarity and user set delays can be also configured this way. For positive polarity, the scan is started with the positive flank and will be fully executed regardless of the trigger in status afterwards. The execution takes ~500ms. After ~1 second the unit is ready for the next trigger event and. Exact timing can be checked using the Trigger out port. Data acquired from a preceding scan is available for reading until the next scan has been taken and was processed. For negative polarity, the scan is triggered by the negative flank on the unit.

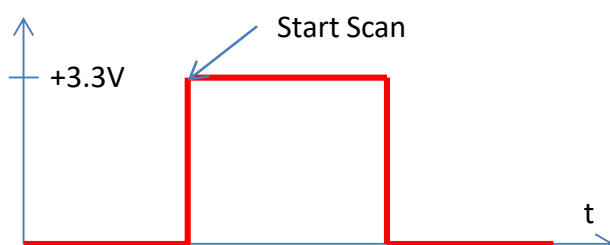

**Trigger OUT** provides an output signal indicating periods at which the unit acquires the optical spectrum. The polarity can be reversed via Remote control or GUI.

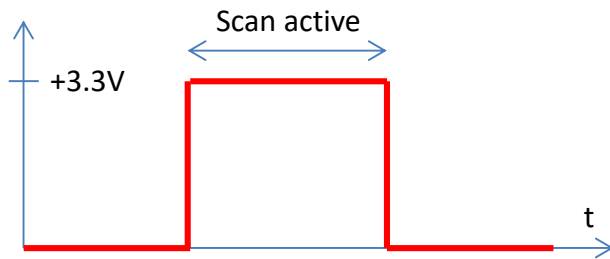

### 2.2.3 DATA PORTS

**Ethernet** – The RJ45 jacket is used to connect the unit to Ethernet networks based on the IEEE 802.3 standard. Per factory default, the unit is set to a fixed IP Address 192.168.0.1. The IP address configuration can be changed via Remote control or GUI. We recommend to initially connecting via USB to set up the Ethernet interface first. See section 4.3 for details on how to establish an application layer connection to remote control the unit.

**USB** – The USB 2.0 type B jacket is used to connect the unit a host computer to be able to operate the supplied GUI or perform remote control on the unit. See section 4.4 for details on how to establish an application layer connection to remote control the unit.

## 2.3 OPTIONAL ACCESSORIES

### 2.3.1 SINGLE 19" RACKMOUNT ADAPTOR ID-OSA-ACC-RM-1

This adaptor is used to mount one ID OSA chassis in a standardized 19" Rack in 1 HE slots.

### 2.3.2 DUAL 19" RACKMOUNT ADAPTOR ID-OSA-ACC-RM-1

This adaptor is used to mount two ID OSA chassis side-by-side in a standardized 19" Rack in 1 HE slots.

## 3 QUICK START

This section contains redundant information from other chapters but is useful for a first-time usage of the instrument.

1. Power up the unit using the main power switch located at the back of the unit or provide 5VDC to the DC line jack.
2. Wait until the boot sequence is completed and the ready indicator located at the front lights up. The chassis fan will start to operate.
3. Connect the USB Port located at the rear of the unit to your Windows10 PC or connect the Ethernet Port to your LAN.
  - a. **For USB** based access, all drivers will be installed automatically, Windows device manager should show now 3 devices:
    1. A storage device containing manual etc.
    2. A virtual Ethernet Interface "RNDIS". The IP Address of this interface is printed on the Product label located on the bottom side of the device.
    3. A virtual COM Port
 Both virtual COM and Ethernet Ports can be used to remote control the unit. The installed COM Port number can be retrieved from Windows device manager. To access the WebGUI, the USB virtual Ethernet IP address is needed. If the DNS configuration of your computer allows, the IP address can also be retrieved by entering the command shell "ping osa.local" or retrieve it from the label located on the unit.



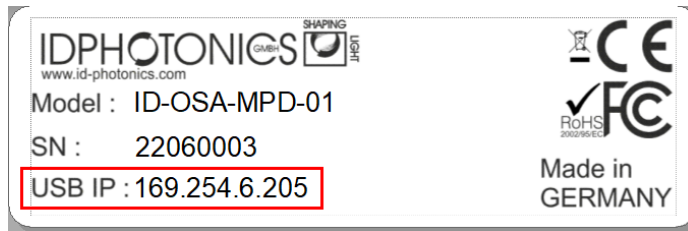

- b. **For Ethernet** based access, the default IP of the unit is <http://192.168.0.1> . Make sure that the host PC IP is in the same subnet as the laser unit (192.168.0.x). If this is not the case, you can change the IP settings of the unit via the USB Port of the unit. Use <http://osa.local/> as an alternative to the IP address to connect to the unit if your DNS configuration of the network allows this access.
- 
4. Open your Web browser, enter <http://osa.local/> or the IP Address as described on previous step in the address field and hit <enter>. The Webpage allowing to control the instrument remotely should open now.

### ! NOTE

Depending on the configuration of your host PC DNS structure, the <http://osa.local/> name representation might not be resolved into the correct IP address. In such a case, there are 2 options to retrieve it:

1. Open a connection to the USB virtual serial interface and type the command “USBIPADDR? ;” to retrieve the USB IP Address or “IPADDR? ;” for the IP address of the Ethernet interface
2. Retrieve the IP address from the type label located on the unit.

## 4 GETTING STARTED

### 4.1 SOFTWARE INSTALLATION

The ID OSA can be operated without installing any software using the integrated webserver. Connect to it using the address field of your computer browser as described above.

### 4.2 HARDWARE INSTALLATION

- Connect the USB or Ethernet interface located at the rear of the unit to the host PC using the provided USB or Ethernet cable of the shipping package.
- Connect the power cable of the shipping package to the power outlet located at the back of the unit to a power socket and toggle the switch next to the power outlet to “1”
  - The “Power” LED located at the front should now light up
  - The “Alarm” LED will light up for a few seconds and then should go off again
  - A few seconds later, the “Ready” LED should light up
- The unit is now ready to operate

### 4.3 ETHERNET CONNECTION

This section covers connectivity using Ethernet, skip this section if you plan on using USB.

The default IP address is 192.168.0.1, DHCP off. If you plan to connect using the Ethernet interface, make sure the host PC is within the same subnet as the ID OSA Ethernet Interface (The PC IP Address is 192.168.0.x then). The connectivity can be tested by opening a command shell (type “cmd” in windows search field and hit <enter>, a “black window with a DOS shell should open) and executing the command “ping 192.168.0.1”.

```

C:\Windows\system32\cmd.exe
Microsoft Windows [Version 6.1.7601]
Copyright (c) 2009 Microsoft Corporation. All rights reserved.

C:\Users\User>ping 192.168.0.1

Pinging 192.168.0.1 with 32 bytes of data:
Reply from 192.168.0.1: bytes=32 time<1ms TTL=64
Reply from 192.168.0.1: bytes=32 time<1ms TTL=64
Reply from 192.168.0.1: bytes=32 time<1ms TTL=64
Reply from 192.168.0.1: bytes=32 time<1ms TTL=64

Ping statistics for 192.168.0.1:
    Packets: Sent = 4, Received = 4, Lost = 0 (0% loss),
    Approximate round trip times in milli-seconds:
        Minimum = 0ms, Maximum = 0ms, Average = 0ms

C:\Users\User>

```

If you do wish to change the IP settings and do not have remote access to the unit follow either of the following sections depending on the type of chassis:

Note that the unit possesses two IP Addresses. One for the physical Ethernet interface and one for the virtual Ethernet Interface generated by a USB connection. Only the one of the physical Ethernet interface settings can be changed and is handled in this section.

#### 4.3.1.1 HOST COMPUTER CAN CONNECT TO CURRENT IP ADDRESS OF ID OSA

Enter IP Address of unit in the browser address field of your host PC browser (default: 192.168.0.1). The ID OSA GUI should now open in the browser window. Go to connection tab, raise user level by entering password "IDP", now change the IP settings and restart the unit to take the new setting into effect.

#### 4.3.1.2 HOST COMPUTER IS UNABLE TO CONNECT TO ID OSA VIA CURRENT IP ADDRESS

Use this method if the "ping test" as described above is not successful.

Connect the unit via USB and wait until driver installation is complete.

Retrieve the COM Port number of the virtual serial port using windows device. Open a terminal window to the virtual COM Port using i. e. PUTTY.

Send the command "pass IDP" to elevate the user level to 1 allowing changes to the IP configuration.

Use the command "ipaddr xxx.xxx.xxx.xxx" to set a new IP address of the physical Ethernet interface where xxx.xxx.xxx.xxx is the IP address you wish to use, ie. "192.168.5.12". For more settings such as DHCP and netmask, see commands defined in section remote control.

You can query the IP address setting via "ipaddr?".

Reboot the unit using the command "\*rst" in order for the new IP configuration to become effective. The unit will immediately reboot after issuing this command.

#### 4.3.2 OPENING A REMOTE CONNECTION VIA ETHERNET

The device supports a session based remote access on Port #2000.

Start the terminal program "putty.exe" supplied with the unit or use any other terminal program.

Set the following parameters in Putty and open the connection:

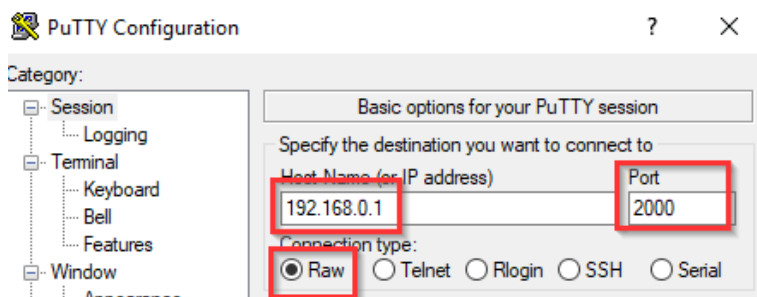

Alternatively, to the default IP Address shown above, enter <http://osa.local/> or the IP address currently set to the unit. If in doubt, use the touch panel display "Device config" – "IP config" to retrieve the actual IP Address.

Note that there must be a valid route on the IP layer between the device and the host PC (i. e. the ethernet port of the host PC is set to the same subnet as the device, for example 192.168.0.2) must be established before continuing.

Use a command shell and command “ping osa.local” to test the route.

Once the connection is established, type in “\*idn?” and hit <ENTER>. The unit responds with its \*idn? String.

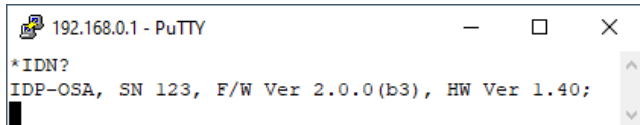

```

192.168.0.1 - PuTTY
*IDN?
IDP-OSA, SN 123, F/W Ver 2.0.0(b3), HW Ver 1.40;
  
```

Alternatively, a request based remote control via http Port 80 is possible. To test this, open a browser window and type the following string into the address field:

[http://osa.local/scpi/\\*idn?](http://osa.local/scpi/*idn?)

In case DNS resolution is not supported on your Host PC, use the IP Address of the instrument instead of “osa.local”.

## 4.4 USB CONNECTION

This section covers connectivity using USB, skip it if you plan using Ethernet.

Once the unit is powered up and the USB cable is connected to the host computer for the first time, a new device installation should be triggered automatically within Windows.

Once installation is complete, three devices are installed on the host computer:

1. Virtual Ethernet Interface. The IP address of each unit is unique and fixed. Retrieve the IP address either by query “USBIPADDR?” or from the type label sticker located on the unit.
2. Virtual COM Port
3. Virtual Storage device that contains resources such as manual and programming devices as well as drivers for Windows 7.

### 4.4.1.1 WINDOWS 10

Windows 10 will automatically install 3 devices allowing to connect the unit

1. A virtual Ethernet interface (RNDIS)
2. A generic virtual COM port driver “Serial USB device”. If you have several COM ports installed in the host PC, you may want to note the COM Port number under which the unit got installed. For further details on USB connection, see section 0.
3. A storage device similar to an USB Stick containing resources for the unit.

The virtual COM Port and the virtual Ethernet interface are concurrent ways to access the unit for remote control. The web-based control is automatically accessed via entering <http://osa.local/> into your browser. If DNS resolution of your PC is not supported, enter the USB IP Address into the address field of the Browser. The IP Address is printed on the device label located on the instrument.

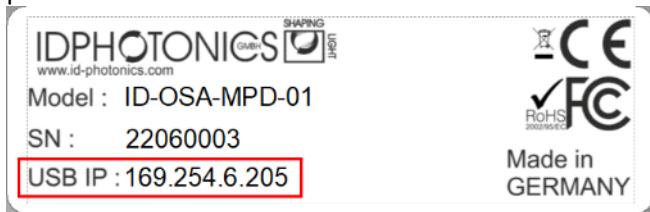

#### 4.4.1.2 WINDOWS 7

Windows 7 will install the same structure as described in the windows 10 section above. It will automatically install a virtual Ethernet interface (RNDIS) and the USB storage device (“Linux File-Store Gadget USB Device”). However, it does not have a preconfigured driver setup for the virtual COM Port. It will try to locate a driver for the unit on the host PC first and then check online. Stop the search and select the option “Install a custom driver”. Point the installation routine to the driver located on the USB storage device provided by the unit in directory “USBDriverWin7” and select file “ID OSA USBSerialDriverWindows7.inf” in this folder. If the installation has been completed already, open Windows Device Manager, locate “CDC Serial”, right click on it and select “Update driver”. Proceed as described before.

Continue with the installation routine. Once installed, the virtual COM port should appear in Windows Device Manager as shown below. The COM Port number will be different for your system. Note down the number for later usage in remote control applications.

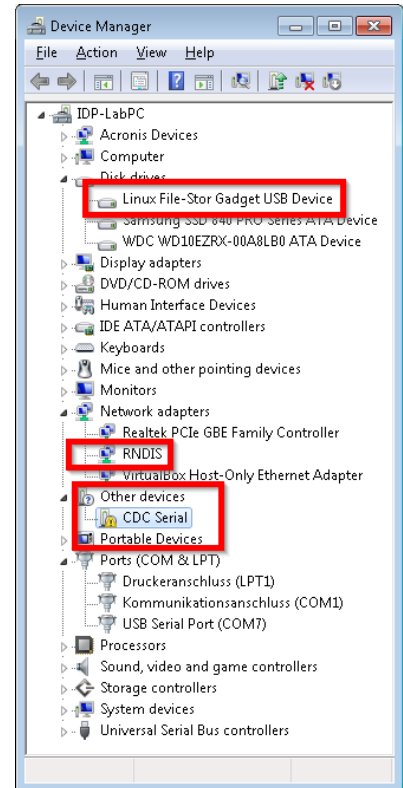

#### 4.4.2 CHECK USB DRIVER INSTALLATION IN WINDOWS DEVICE MANAGER

Once the installation is completed, a check for successful installation can be performed by opening Windows Device Manager, i. e. press <Windows Key> + <Pause> and click on “Device Manager”.

##### 4.4.2.1 CONNECTION TO THE DEVICE VIA USB VIA HOST PC

Once installed properly, the USB connection provides a virtual COM Port and a virtual Ethernet Port to the instrument.

#### 4.4.3 CONNECTION VIA VIRTUAL ETHERNET PORT ON USB

To access the unit via virtual Ethernet, follow the instructions as in section 4.3.2 but note that the IP Address of the unit will be different as for the physical Ethernet Port and cannot be changed as it is assigned by the Windows host PC upon installation.

#### 4.4.4 CONNECTION VIA VIRTUAL SERIAL PORT ON USB

Use any terminal program such as “Teraterm” or “Putty” which can be found on the supplied USB Stick to test custom remote control.

The connection parameters are:

- Baud rate: 115.200
- Serial settings: 8N1

Once connected, type i.e. “\*idn?” and press <ENTER> to test the connection. This command queries info’s about the OSA. A typical response is

```
IDP-OSA-MPD-01, SN 1703001, F/W Ver 1.0.0(56), HW Ver 1.10;
```

#### 4.5 CONNECT WITH GRAPHICAL USER INTERFACE

We recommend using the WebGUI which is accessed by either entering the **IP Address** (default <http://192.168.0.1> for Ethernet) <http://osa.local/> into your browser address field to open it.

##### 4.5.1 CONNECTION VIA ETHERNET

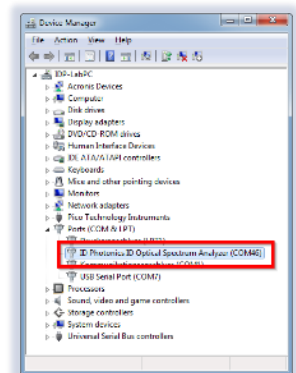

The default IP 192.168.0.1 for Ethernet based access. This Graphical User Interface (GUI) can only be accessed if the unit is connected to the same Ethernet network as the host unit running the Web Browser and the IP Address is properly set up so that it is reachable from the host PC. If the Ethernet interface is not yet configured for the network to be used, first connect to a host PC using the USB Interface to set up the Ethernet Interface, see 4.3 for details.

#### 4.5.2 CONNECTION VIA USB

Alternatively, the USB Interface can be used to access the GUI via the virtual Ethernet Adaptor that is installed on the host PC. For details, see 4.4.

## 5 GRAPHICAL USER INTERFACE – WEB INTERFACE (WEBGUI)

The integrated web server of the unit allows to access and control the unit using any compatible Web Browser on any device without installing software. The Web Interface was tested on Windows 7 and Windows 10 Computers using Edge, Chrome and Firefox and iPhone/iPad using Safari browser. Note that we cannot guarantee operation in any Browser environment in general.

Hover the mouse pointer over the areas of interest. Tooltips will appear with context sensitive help.

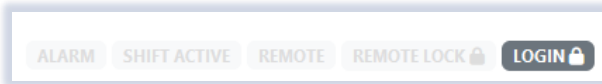

The browser tab indicator includes the serial number of the unit currently accessed so that if multiple units are accessed at the same time can be differentiated easily.

The top right side hosts a number of status indicators that highlight system wide settings and will change color, if active.

The alarm indicator will indicate and active or latched alarms. Click on the icon to access further details.

The “shift active” indicator indicates if non zero numbers are set in the “wavelength shift” or “level shift” fields in the System tab to remind the user that the values contain an offset relative to the actual measured values.

“Remote” indicates that there are active remote sessions.

“Remote lock” indicates that the device does not accept set commands via remote connections (reading is still possible) due to a forced setting in one of the active sessions. For details, see the remote-control section of this manual.

The login button allows to elevate the user rights of the active session to access protected settings such as the IP Address configuration. The protected settings are highlighted by a lock symbol, if locked.

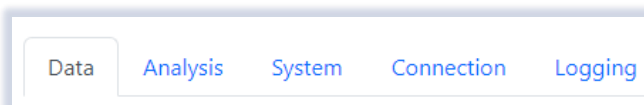

The graph window does have tabs that allow access to more features of the device. Click on the tabs to access more features of the unit. Please see the following section for a detailed description of the objects in these tabs. All objects do have a short description displayed if the mouse pointer is hovered over the object.

The following screenshots document the tabs for your reference.

### 5.1 DATA TAB



This tab is designed to display the measured trace and configure most of the measurements.

The optical power shown by the filling slider is the integrated power across the spectrum measured by the unit.

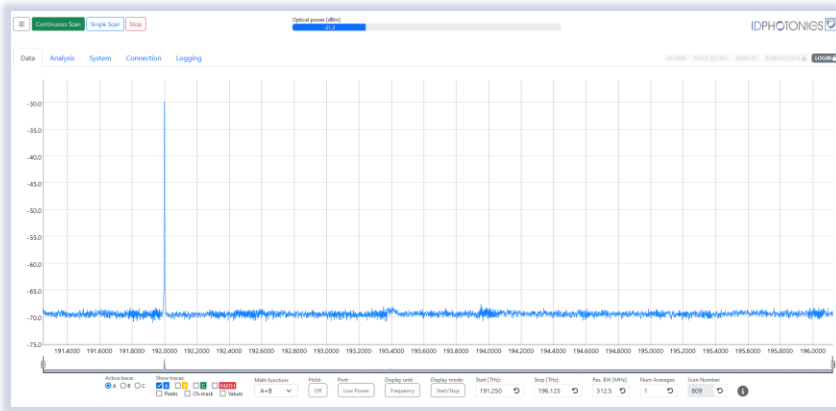

Note that parameter changes performed by one user will impact the analysis output of any other user connected to the unit in parallel.

Use the slider shown below the graph to zoom into areas of the measured data. The data outside of the zoomed area is still measured and depicted in the slider. The selected area can be moved by dragging the selected area with the cursor.

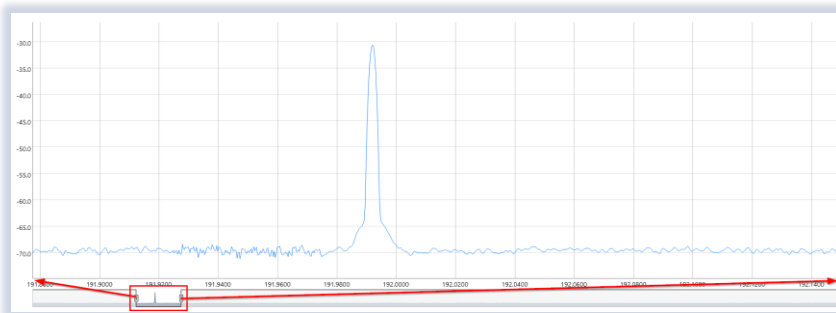

Alternatively, it is possible to zoom in via marking the area of interest using the cursor in the main graph.

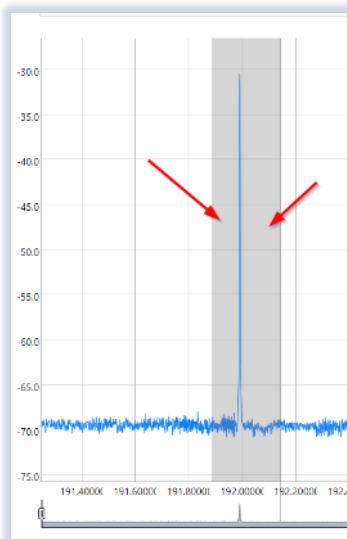

A double click anywhere in the graph restores the full view.

Use single cursor clicks to set markers. Each click adds a marker for the current values are shown in a box. Remove all markers using the box in the upper left side.

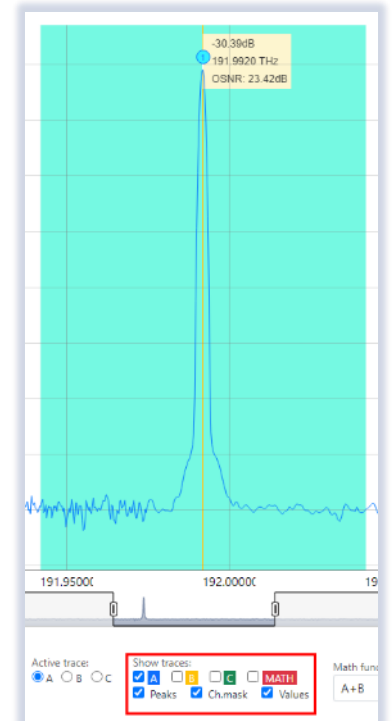
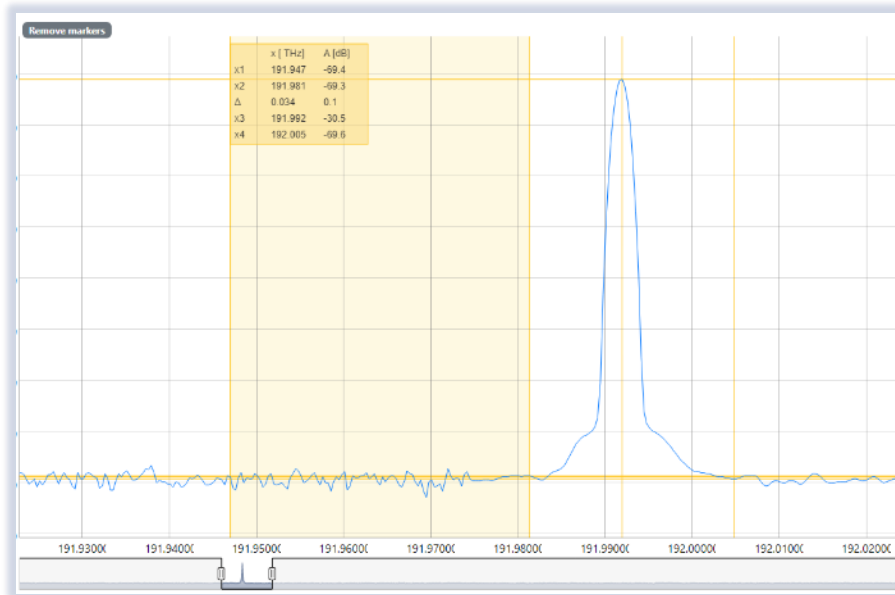

Use the checkboxes located in the lower part to make the channel mask of detected peaks visible and show analysis results.



The menu icon allows access to various resources such as drivers, programming examples, saving data and system level features. Click on it to unfold the menu.

**Continuous Scan**

This button will enable the repeating measurement mode of the instrument. Spectrum scans will be endlessly performed independently of the GUI connected or not.

**Single Scan**

This button triggers a single spectral scan. If the previous mode was “repeat”, this is aborted.

**Stop**

This button aborts pending spectral scans.

The menu panel contains the following sections and items:

- Trace**
  - Save data of current trace
- Downloads**
  - User Manual
  - USB Ethernet Driver for Windows 7
- Getting help**
  - Download service logs
  - Run service scripts...
  - Give product feedback
- Remote control code**
  - Download example for LabView
  - Download example for Matlab
  - Download example for PowerShell
  - Download example for Python
- Unit management**
  - Update device firmware...
  - Restart unit...
  - Shutdown unit...

The lower pane allows to configure traces, set start and stop Frequency or Wavelength, and further parameters that are relevant for the setting up the measurement. Hover the cursor over each field to obtain further details for each one.

The configuration bar includes the following settings:

- Active trace: A (selected), B, C
- Show traces: A (checked), B (checked), C (checked), MATH (checked)
- Peaks: (unchecked)
- Ch.mask: (unchecked)
- Values: (unchecked)
- Math function: A+B
- Hold: Off
- Port: Low Power
- Display unit: Frequency
- Display mode: Start/Stop
- Start [THz]: 191.250
- Stop [THz]: 196.125
- Res. BW [MHz]: 312.5
- Num Averages: 1
- Scan Number: 1362

Stop [THz]:  
196.125

Click on the return icon to reset values to its default setting.

## Display Mode

Frequency

This button toggles between wavelength and frequency-based display of data.

Start/Stop

This button toggles between Start Stop and Center Span definition of the ID OSA scan range.

High Power

The Port button toggles the input port of the unit that is currently used. See section 2.1.2 for details.

## Num Averages:

5

Will change the internal moving average applied to the last n successive scans of the unit.

## Hold:

Off

Allows the trace data points to hold either the maximum or minimum power points measured since enabled.

## 5.2 ANALYSIS TAB

The analysis tab provides a table with data computed for peaks detected in the spectrum and allows changing parameters for the analysis. For Details on the settings, see 6.3. The data can be exported using the “Save analysis results” button.

**WDM analysis results**

Number of channels detected: 1

Save analysis results

CH number	Frequency [THz]	Peak power [dBm]	OSNR [dB]
1	191.9917	-30.41	23.29

**WDM analysis settings**

Ch P-V Threshold [dB]: 10.000

Peak mode difference [dB]: 0.000

Min peak distance [GHz]: 0.313

Channel mask [GHz]: 100.000

Peak power mode: Peak

**WDM analysis error status**

Analysis OK

The left-hand side displays a table with peaks detected in the spectrum based on parameters defined on right hand side.

Note that all calculations required for the analysis are performed inside the ID OSA unit. Therefore, if a preciously trace saved to the host computer disk, the analysis cannot be performed by the GUI. Furthermore, parameter changes in the Analysis Tab performed by one user will impact the analysis output of any other user connected to the unit in parallel.

## 5.3 SYSTEM TAB

The System tab hosts various system wide settings. Hover the cursor over the fields to access a detailed description of them.



The screenshot shows the 'Settings' tab with the following configuration:

- Sweep Interval [s]:** 0.000
- #Scan Averages:** 1
- Wavelength Shift [nm]:** 0.000
- Level Shift [dB]:** 0.000
- Config ID:** 20
- Spectral correction:** is disabled
- External trigger control:**
  - External trigger is disabled
  - Trigger IN polarity is 1
  - Trigger OUT polarity is 1
  - Trigger Delay [ms]: 0.000
- Settings storage:**
  - Save current status
  - Reset all user settings

## 5.4 CONNECTION TAB

This tab is used to retrieve or set information on the remote-control interfaces of the unit, device info and information about current firmware and identification of the unit. Hover the cursor over the fields to access a detailed description of them.

The screenshot shows the 'Connection' tab with the following configuration:

- Network settings:**
  - DHCP: is disabled
  - IP address: 192.168.0.1
  - Gateway IP: 192.168.0.255
  - USB Port Virtual Ethernet IP Address: (empty)
  - Reset all network settings to defaults
- MAC-Address:** 50:2D:F4:28:2E:99
- Netmask:** 255.255.255.0
- Device info:**
  - Idn: ID-OSA-MPD-01, SN 22290014, F/W Ver 2.1.0(325), HW Ver 1.50
  - Identify unit is disabled
- Connection status:** (indicated by a blue dot)
- SCPI control:**
  - Send command: \*idn?
  - Abort pending commands

Enter any SCPI command supported by the unit. The response will be displayed in a popup window. For details on the command structure, see chapter 7.

### SCPI

#### Command

\*idn?

## 5.5 LOGGING TAB

The logging tab allows to track the SCPI commands that are exchanged with the unit in this browser session coming from user interactions. This feature can be helpful for rapid development of remote-control scripts.

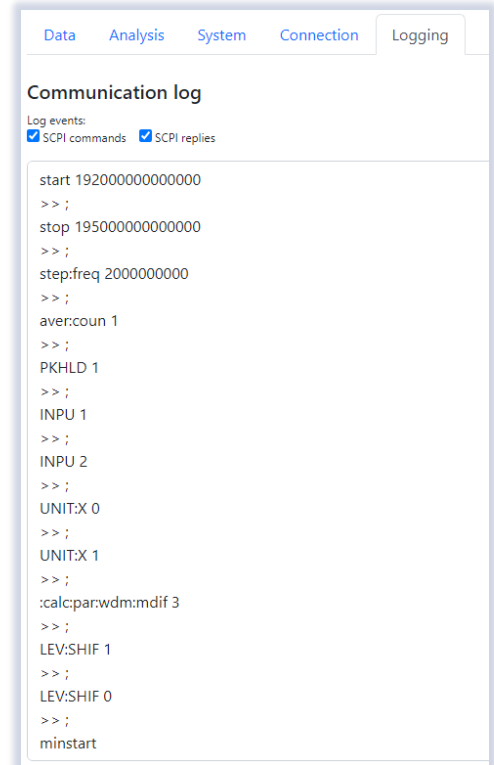

The screenshot shows a web interface with a top navigation bar containing tabs for 'Data', 'Analysis', 'System', 'Connection', and 'Logging'. The 'Logging' tab is active. Below the navigation bar, the title 'Communication log' is displayed. Underneath, there are two checked checkboxes: 'SCPI commands' and 'SCPI replies'. The main area contains a list of log entries, each starting with a timestamp and followed by a command or reply. The entries are as follows:

```
start 1920000000000000
>> ;
stop 1950000000000000
>> ;
step:freq 2000000000
>> ;
aver:coun 1
>> ;
PKHLD 1
>> ;
INPU 1
>> ;
INPU 2
>> ;
UNIT:X 0
>> ;
UNIT:X 1
>> ;
:calc:par:wdm:mdif 3
>> ;
LEV:SHIF 1
>> ;
LEV:SHIF 0
>> ;
minstart
```

## 6 GENERAL CONCEPTS OF THE ID OSA

### 6.1 RESOLUTION BANDWIDTH AND SAMPLING INTERVAL

The resolution bandwidth of the OSA (RBW) is an independent parameter of the sampling interval (SI) of the OSA. The minimum effective filter bandwidth of the unit is limited to 1.7GHz and the sampling interval to 312.5MHz. If the sampling interval is set below RBW, an oversampling occurs and the OSA filter is acting like a moving average filter on the sampled signal. If the sampling interval significantly exceeds the OSA Filter bandwidth, the effective filter shape for each sampling point becomes close to a rectangular shape since the OSA bandwidth is small relative to the sampling interval. Please see the next paragraph for details on computation of the filter for sampling intervals > 312.5MHz.

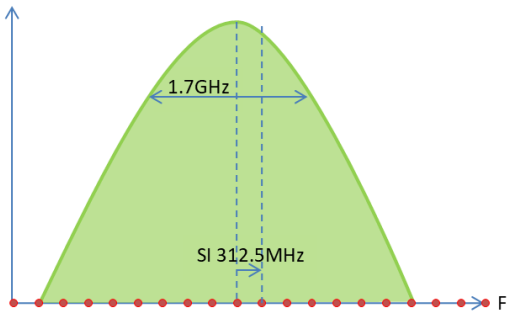

Sampling interval of 312.5MHz (not to scale)

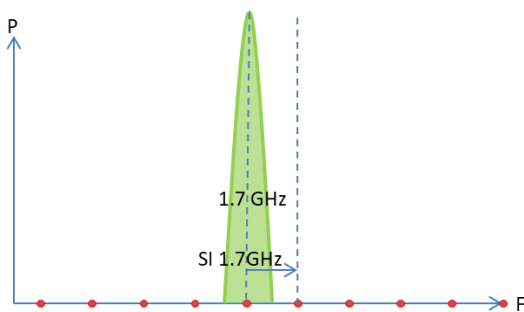

Sampling interval of 1.7GHz

Note that internally, the power for each data point is summed up by the scheme explained in next paragraph.

### 6.2 MAPPING

The ID OSA will always internally scan with the maximum resolution available regardless of the user setting yielding 15600 data points equally spread across the acquired spectrum with a distance of 312.5MHz per data point. Once the data was acquired it is internally mapped and filtered by a moving average filter. The width of this filter is defined by the user defined RBW (SCPI Command `STEP`). If the RBW is not a multiple of 312.5MHz, the unit will linearly interpolate the contribution of the data points at the edges of the filter into the result. The resulting frequency available at the SCPI interface is the center of the RBW filter. The interpolation will be done internally in linear domain regardless of the user setting by the SCPI interface of dBm (log) or mW (linear).

By changing the number of Points (SCPI Command `POI`), the step size of the moving average filter can be increased up to the width of the RBW filter.

Note that the minimum start (`MINSTAR`) and maximum stop (`MAXSTOP`) Frequency/Wavelength will change as RBW is increased to accommodate for the wider filter. The maximum number of points (`MAXPOI`) will also be

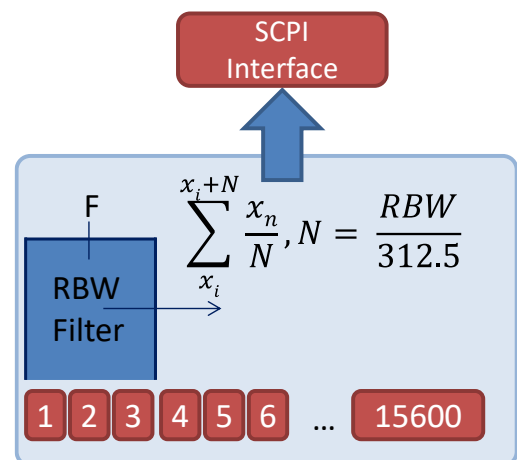

impacted by an increase of RBW (STEP). The following formulas are given for Frequency based X Axis but apply similarly:

$$\text{MINSTAR} = 1.9125\text{E}14 + \text{RBW} / 2$$

$$\text{MAXSTOP} = 1.96125\text{E}14 - \text{RBW} / 2$$

$$\text{MAXPOI} = 15600 - \lfloor \text{RBW} / 3.125\text{E}8 \rfloor$$

If start (STAR) and stop (STOP) of the scan are set to the minimum (MINSTAR) and maximum (MAXSTOP) possible and RBW (STEP) is increased, new (STAR) and stop (STOP) settings will be automatically set by the unit. The Example below illustrates the mechanism for a simple case of an RBW with of  $3 * 312.5\text{MHz} = 937.5\text{MHz}$  is shown.

## 6.3 AUTOMATIC MEASUREMENTS

### 6.3.1 OSNR MEASUREMENT

The OSNR measured is performed according to definitions in IEC 61280-2-9 standard.

OSNR is calculated for each peak found by the Peak detection feature which also delivers the peak power.

The Noise power referenced to 0.1nm is determined by the first data points outside of box centered on the Peak defined by the OSNR mask parameter. The noise level at signal wavelength is calculated by means of linear interpolation. The OSNR is then calculated by the following formula with all input variables in [dB]:

$$\text{OSNR [dB]} = (P_i + N_i) - N_i$$

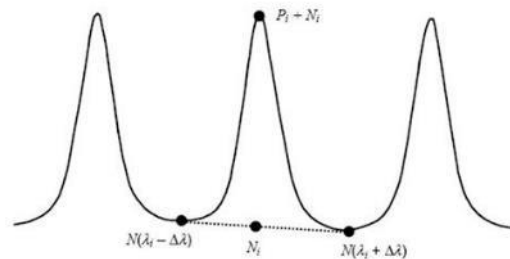

#### 6.3.1.1 IMPACT OF CHANGING THE ID OSA RESOLUTION BANDWIDTH (RBW) ON OSNR RESULT

Independent of the RBW, the algorithm will always automatically scale the noise power  $N_i$  to 0.1nm reference so that the derived noise power will not change if the RBW is changed.

The Peak Power  $P_i$  will change as RBW of the OSA is changed as long as the signal is spectrally wider than the OSA filter which acts as moving average window across the signals as it sweeps. RBW needs to be at least as wide as the signal width to capture the signal total power. For a signal with unknown width, the minimal required RBW for a valid OSNR measurement can be found by increasing RBW until the OSA trace tends to flatten at the peak indicating that the OSA filter is wider than the signal width.

Note that at full sampling rate, the OSA oversamples the signal so that the peak power detected will be lower than the actual peak power of even a very narrow signal such as a continuous wave narrow line width laser. For peak detection, increase the RBW such that it matches the minimum filter bandwidth of the OSA. This value is about 2GHz. See section 6.1 for more details.

If the Signal Under Test is wider than current set resolution of the unit, either decrease RBW until the full signal is captured or use the integrating power setting for peak power detection. For more details, the section 6.3.2.1.

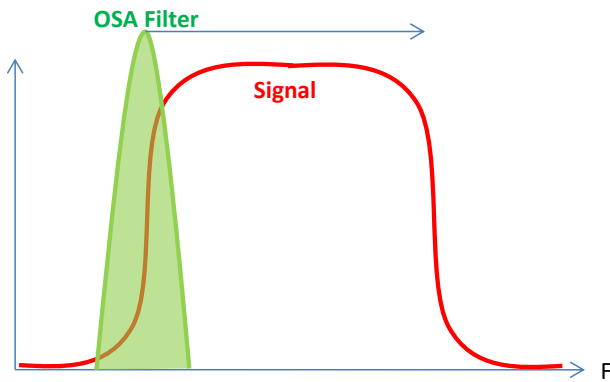

### 6.3.2 PARAMETER DEFINITION

**Channel mask area:** Parameter defines the width of a box centered on a detected peak as indicated in the diagram below. It defines the data points for which the Noise is calculated for. This parameter also set the power integration width for peak power if the mode is set to “integrate”.

#### 6.3.2.1 PEAK PARAMETER DEFINITION

These parameters define criteria which qualify a data point to be a peak detected by the peak algorithm. Each criterion must be fulfilled in order to qualify as a peak.

**Channel P-V threshold:** (PVT in Diagram): Defines the minimum power difference of a data point relative to the lowest power data point present in the trace. Example: Minimum Power  $P_{min}$  in trace is  $-50\text{dBm}$ ,  $PVT = 25\text{dB}$ . Data points with a power of  $> -25\text{dBm}$  ( $-50\text{dBm} + 25\text{dB}$ ) meet this criterion.

**Peak Mode difference:** (PMD in Diagram): Defines the minimum power drop threshold between peaks. Example: If PMD is  $10\text{dB}$  and the power drops by  $5\text{dB}$  between data points meeting the PVT criteria, only the first peak meets both criteria.

Explanation based on the example diagram shown below:

- “1” qualifies as a peak –indicated by a green dot – because it exceeds the PVT and as it is the first peak, the PMD criteria is not applicable
- “2” does NOT qualify as a peak. It exceeds the PVT but does not meet the PMD criteria relative to “1”
- “3” qualifies as a peak as it exceeds the PVT and meets PMD criteria relative to the first detected peak “1” as power drops below  $P(1) - \text{PMD}$ .
- “4” does not qualify as a peak since the max power is below  $P_{min} + PVT$ .

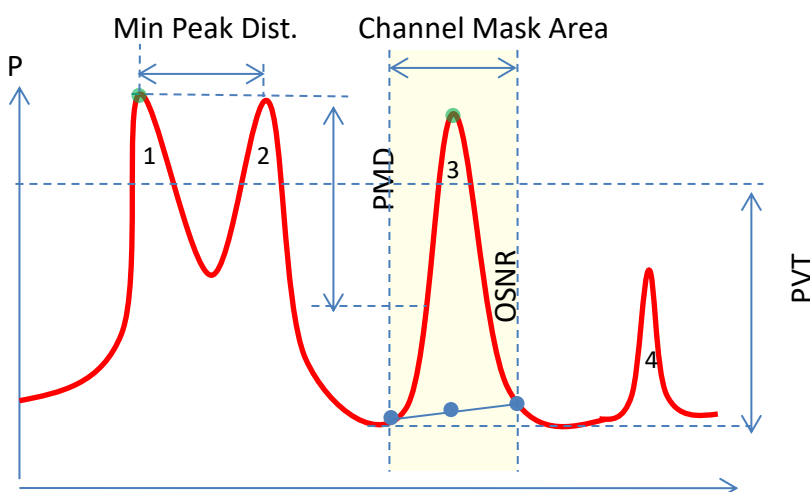

**Min. Peak Distance** – Allows to screen for peaks which a minimum of spectral distance given by this threshold. With a Threshold of  $50\text{GHz}$ , each peak following a previously detected peak with a distance of less than  $50\text{GHz}$  is ignored.

**Peak Power Mode** – This drop down can be set in two modes:

1. **Peak** (setting 0) – This mode will determine the power of the peak in the sampling point of the maximum power. If the Signal Under Test is wider than that, power will be distributed in neighboring samples. This power is NOT taken into account for power calculation. Increase the RBW to capture the signal power in adjacent samples as well.
2. **Integrate** (setting 1) - This mode will determine the lateral peak position by finding the sample with highest power. It will then integrate the signal power distributed in all samples that are defined within the Channel Mask parameter. By this mode, the detected Peaks power will be independent of the RBW set on the unit as long as RBW is smaller than the channel width parameter. Use this method to measure the power of spectrally wide signals that exceed the current RBW setting.

### 6.4 AVERAGING

ID OSA provides two averaging mechanisms which are connected in a nested loop as depicted in the flow chart below.

**Scan Averages** will take the number of specified scans and calculate the average out of the scans taken. Once this procedure is completed the scan counter is increased by 1 and the result is available to the user via the SCPI interface or GUI. There is no user access to intermediate scans within that procedure and unit will remain busy until it completes. Therefore, a result is only available for the SCPI Interface and GUI once the required number of scans has been taken and the refresh rate to the user will decrease linearly with the number of scan averages set to the unit.

**Moving Averages** (# Averages in GUI) will calculate an average of scan from the scan average input (=scan set) in a “First In First Out” (FIFO) logic. A result is immediately available at the SCPI once a first scan is in the FIFO buffer. The scan number counter will increase for each scan that is put into the buffer. The full averaging is achieved once the specified number of scans was filled into the buffer. For each scan put in thereafter, the oldest scan in the buffer is discarded. If OSA settings such as RBW, start, stop etc. are changed, the buffer is emptied and will be gradually filled as described. If the number of moving averages (NMA) is changed, data will NOT be discarded but the average calculation will be adapted accordingly. I.e. if NMA is changed from 10 to 20, the new buffer will already have 10 sets in it and will gradually add sets as they become available.

The total number of scans averaged is calculated by: Scan Averages \* Moving Averages

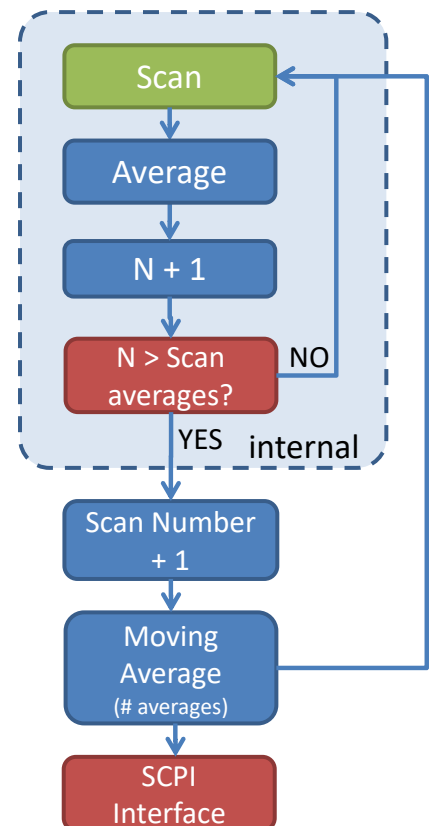

The following example illustrates the mechanism and terminology. The unit takes 3 scans (red boxes) internally which are averaged (blue) and assigned a scan number. It is then fed into the moving average buffer containing 4 sets in this example. Since scan number 5 exceeds the buffer size, scan set number 1 is discarded. The total number of scans required to fill the buffer is therefore  $4 * 3 = 12$ . First data is available to the user upon completion of the 3<sup>rd</sup> scan which is stored in scan set 1.

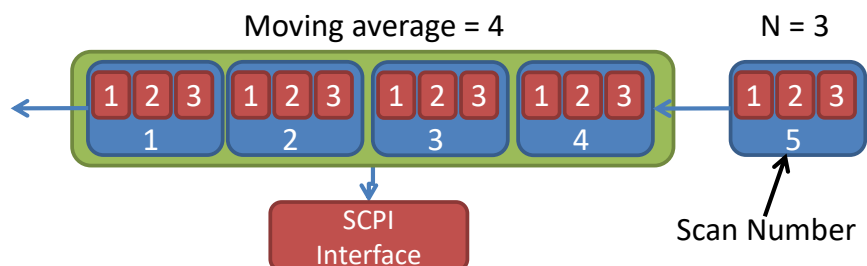

## 6.5 SPECTRAL CORRECTION

This feature allows applying a spectral correction vector to the data measured by the unit. The feature can be switched on and off in the system tab. By default, the correction vector elements are all set to 0. The correction applies on the maximum resolution grid provided by ID OSA which is 312.5MHz yielding to 15600 elements spread across the maximum scan range available. The correction vector defined in [dB] is stored in the ID OSA unit and internally applied to the raw data measured. If the feature is enabled, data provided by the unit will internally calculate a new power data point based on the correction:

$$P_{out,i} = P_{measured,i} + Correction_i$$

The following diagram depicts the correction visually. Blue bars represent measured raw data points, red bars represent correction values defined by the correction values. The sum of red plus blue bars is the data reported power vector by the unit.

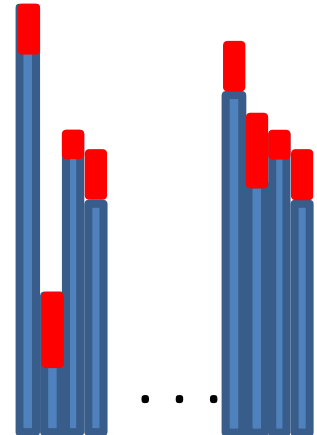

If RBW is changed, ID OSA will automatically calculate the correction vector and the result remains valid based on the vector stored in the unit.

## 7 REMOTE CONTROL

This device operates using SCPI standard style commands which are ASCII based and allow easy communication and interpretation with the instrument. Refer to chapter “Board and Connector description” on how to establish communication to the ports available at the instrument. More detailed information on SCPI syntax can be found here: <http://www.ivifoundation.org/docs/SCPI-99.PDF>

The following description is based on Firmware 2.1.0 or later.

### HOST COMPUTER DRIVERS AND IMPLEMENTATIONS

#### 7.1.1 LABVIEW

National Instruments LabView® drivers covering all SCPI commands are supplied with the USB stick delivered with the unit in directory “\RemoteControl\LabViewDrivers”. The drivers are compatible to National Instruments LabView® R8.6 or later.

#### 7.1.2 MATLAB

A Matlab script demonstrating remote operation of the ID OSA is supplied with the USB stick delivered with the unit in directory “\RemoteControl\Matlab”.

#### 7.1.3 PYTHON

A Python object script demonstrating remote operation of the ID OSA is supplied with the USB stick delivered with the unit in directory “\RemoteControl\Python”.

#### 7.1.4 POWERSHELL

PowerShell is a simple scripting language built into Windows Operating system. A demo script for remote operation of the ID OSA is supplied with the USB stick delivered with the unit in directory “\RemoteControl\PowerShell”.

### 7.2 OPERATING MULTIPLE INTERFACE PORTS

This unit supports parallel usage of all remote-control ports available. Note that responses to commands issued are only returned to the according port from where the command was issued.

Commands are generally executed in order of time wise arrival to the controller and buffered into an Event queue. If a stack overflow occurs, an error is issued.

Note that there is no control exclusivity for a specific interface or user. Thus, parallel commands issued by different instances will be might lead to inconsistencies. It is therefore recommended to poll current parameter status to

ensure integrity of set vs. actual parameters and query the operation complete register (“\*opc?”) to make sure all previous commands have been executed.

## 7.3 SYNTAX CONVENTIONS FOR COMMANDS

### 7.3.1 LONG AND SHORT FORM

The key words feature a long form and a short form. Either the short form or the long form can be entered, other abbreviations are not permissible.

Example: :SYStem:IPADDRess?= IPADDR?

#### ! NOTE

The short form is marked by upper-case letters; the long form corresponds to the full expression. Upper-case and lower-case notation only serve the above purpose, the instrument itself accept both upper-case and lowercase letters.

#### ! NOTE

All commands are case insensitive. Long and short form may not be mixed within a single command.

### 7.3.2 QUERY COMMANDS

Most commands serve a double function that allows either setting or executing a query on a parameter.

#### ! NOTE

Query commands are terminated by a “?” character.

### 7.3.3 PARAMETER

Parameters must be separated from the header by a "white space". If several parameters are specified in a command they are separated by a comma ",".

### 7.3.4 COLON CHARACTER

A leading colon character `:' instructs the instrument to interpret the command starting at the root (highest level) of the command tree. Since the Instrument also starts at the root each time you send it a new command, the leading colon is not required (although the instrument will accept it if you send it).

### 7.3.5 COMMAND TERMINATION CHARACTER

Each command must be terminated either by a “;” = 0x3B character or a line feed <LF> = 0x0A to signal completion of the command telegram to the controller. Depending on settings of the connection, the host buffer is only sent to the unit if a <LF> is used. Therefore, it is recommended using <LF> for sending commands. The response termination is always “; <LF>” = 0x3B0A. In this documentation, the <LF> is not shown to enhance readability.

#### ! NOTE

Sending two termination characters is a common mistake causing the unit to respond with “ERR 100; <LF>” since the first command is executed once the first termination character is received and the second termination character causes the unit to interpret an empty command. Example:

Command: “STEP 1e+9; <LF>”

Response “; <CR>ERR 100, unknown command; <LF>”

The unit will execute the command but additionally receives the empty command which causes the error response.



### 7.3.6 ACKNOWLEDGEMENT OF EXECUTED COMMANDS

The controller will always acknowledge successful execution of commands by a “; <LF>” character. If the echo option is set (for details, see command list), the accordingly sent command is returned first.

### 7.3.7 COMMUNICATION EXAMPLE

Host sends: \*idn?;

ID OSA response: IDP-OSA-MPD-02, SN 17120007, F/W Ver 1.0.0(54), HW Ver 1.10;

### 7.3.8 BASIC SCRIPT EXAMPLE

The following commands can be a minimal script to perform a basic set up of the unit and read the data

COMMAND	COMMENT
STAR 1.9282e+14;	Set Start of scan to 192.82THz
STAR 1.9531e+14;	Set Stop of scan to 195.31THz
STEP 1e+10;	Sets the Sampling interval to 10GHz. It is equal to the Resolution Bandwidth (RBW) for this value.
SGL;	Trigger a single Scan
*WAI;	The response to this query is only given if *opc? status is 1 (=execution of SGL command is completed). Otherwise query of spectrum in next steps will be data stored in buffer from previous scan.
FORM ASCII;	Set the coding for traces responses to ASCII
X?;	Retrieve X Axis = Frequency vector (response is ASCII coded)
Y?;	Retrieve Y data = Power vector (response is ASCII coded)

### 7.4 USER ACCESS LEVEL

This feature allows execution of commands protected in standard access level to avoid accidental change of important parameters. See command description “[ :SYStem: ]PASSword” for details on how to enable enhanced access.

#### NOTE

User access level is granted session based. Each time, a new remote connection is made; the standard User access level 0 is set per default.

USER ACCESS LEVEL	PASSWORD
0	-
1	IDP

## 7.5 NOTATION OF SYNTAX FOR COMMAND DEFINITION

SYNTAX AND TYPE	DESCRIPTION
[ ]	Optional command level that can be omitted. Example: Definition [:SYStem:]IPADDRess/? /<P> Allows sending the command: IDADDR?
< >	Denotes a parameter. Placeholder is replaced with parameter value defined for according command. Definition [:SYStem:]IPADDRess/? /<P> Allows setting the parameters: [:SYStem:]IPADDRess 192.168.0.1
/?	Denotes the optional character “?” that is used if the command can also be used as a query. Example: Definition [:SYStem:]IPADDRess/? /<P> “?” is used to query current IP Address of the device: IPADDR?;
:, *	Usage of Colon see 7.3.4
<wsp>	Denominates a white space character
<INT>	Integer value
<REAL>	Real value

## 7.6 GENERAL SCPI COMMANDS

SYNTAX	EXAMPLE	DESCRIPTION
*idn?	*idn?; IDP-OSA-MPD-01, SN xxx, F/W Ver xxx, HW Ver xxx;	Query System Type and Software version
*opc?	*opc?; 1;"	Query if all pending commands were executed
*rst	*rst; ;	Reset Controller; will cold start the instrument. All connections/sessions will be closed. Requires user level 1
*WAI	*WAI; ;	Wait with response until *opc? Is 1 and then acknowledge command. Eliminates need for polling loop of *opc? on remote side
*CLS	*CLS; ;	Clears all status/alarm registers of the unit. This command is used to clear latched alarm registers.

## 7.7 COMMANDS ON SYSTEM LEVEL

SYNTAX	READ WRITE	USER ACCESS LEVEL	PARAMETER FORMAT	DESCRIPTION
[:SYStem:]ECHO/?/<wsp><P>	RW	0	"0" or "1"	Sets or query echo command sent status, this setting applies to current session only

SYNTAX	READ WRITE	USER ACCESS LEVEL	PARAMETER FORMAT	DESCRIPTION
[ :SYStem:] SaveCurr STAtE	W	0	-	Saves current settings permanently. Note that this command is queued by the device. So, it might be executed after a response is returned. Therefore, it is recommended to make sure the command has actually been executed and the command pipeline is empty using *OPC? or *WAI before sending new commands that change the configuration.
[ :SYStem:] DEFault	W		-	resets user setting such as start/stop sweep wavelength to default
[ :SYStem:] INfOrmat ion?	R	0	IDP-OSA-MPD- 01, SN xxx, F/W Ver xxx, HW Ver xxx	see *idn? for detailed description
[ :SYStem:] DHCP/?/ wsp><P>	RW	1	"off" or "on"	configure DHCP Setting for Ethernet interface
[ :SYStem:] IPADDRes s/?/<wsp><P>	RW	1	xxx.xxx.xxx.xxx	IP Address Setting of Ethernet interface
[ :SYStem:] NETMASK/ ?/<wsp><P>	RW	1	xxx.xxx.xxx.xxx	Netmask Setting of Ethernet interface
[ :SYStem:] GATEWAYI P/?/<wsp><P>	RW	1	xxx.xxx.xxx.xxx	IP address for Gateway of Ethernet interface
[ :SYStem:] DNSIP/?/ <wsp><P>	RW	1	xxx.xxx.xxx.xxx	IP address for 1st DNS of Ethernet interface
[ :SYStem:] DNSIP2/?/ <wsp><P>	RW	1	xxx.xxx.xxx.xxx	IP address for 2nd DNS of Ethernet interface
[ :SYStem:] MACADDRE SS?	R	0	XX:XX:XX:XX:X X:XX	Reads MAC Address of unit
[ :SYStem:] USBInit	W	0	-	Reset session parameters to defaults. Call this after opening the USB port (since the unit cannot detect USB disconnects/reconnects if the USB cable isn't disconnected). This commands resets ECHO, PASS, FORMAT, UNIT:X, LINLOG, EVENT.
[ :SYStem:] REMote?	R	0	"0" or "1"	Query remote status of device. Any open remote sessions via Ethernet?
[ :SYStem:] PASSword /?/<wsp><P>	RW	0	ASCII	Set new User level status by sending password or query current User level status

SYNTAX	READ WRITE	USER ACCESS LEVEL	PARAMETER FORMAT	DESCRIPTION
[ :SYStem:]TIME?/ <wsp><P>	R/(W)	0	xxxxxxxx	Query or set system time. Note that time is set and tracked in volatile memory only. It requires to be set after each cold start.
[ :SYStem:]ALARm?	R	0	xxxxx	Query alarm status of device, see Alarm code definition for details
[ :SYStem:]STATus?	R	0	"INIT";"FAULT" ,"READY";"OVERLOAD"	Query current state of OSA; see Alarm state for match
[ :SYStem:]ERRor[:N EXT]?	R		-	Queries data in an error queue and deletes it from the queue.
[ :SYStem:COMMUnica te:]LOCKout/?	RW	1	"0" or "1"	Locks other sessions to perform write commands on the unit. It is automatically released if the active session closes
[ :SYStem:COMMUnica te:]ParameterREFre sh?	R	0	<INT>	This query allows detecting if any change to the OSA configuration was done. Each time the counter increases, the configuration was changed. This is useful in multi-user environments to detect if a parallel session has changed settings on the unit
[ :STATus:OPERation :]EVENT?	R	0	-	Read status of instrument if scan has been completed (1) or not (0). Each read of "EVENT?" will clear the status for each remote session separately. This can be used to query if previous scan has been completed.
[ :]ABORT	W	0	-	Aborts all currently executed pending commands as fast as possible. Query *OPC? To determine status once all pending commands are aborted
[ :BOOT:]BootLoaDer RESet	W	0	-	Resets upload procedure for firmware upgrade. All data uploaded already is erased. New process can be restarted
[ :BOOT:] BootLoaDerAPPend	W	0	binary	send portions of the binary Firmware Image, each Byte is coded into 2 Characters 1..F, send max. 100 Bytes per command
[ :BOOT:]BootLoaDer EXECute/?	RW	0	-	Set: Executes upgrade of previously uploaded Firmware image. Query responds with current status of execution.

SYNTAX	READ WRITE	USER ACCESS LEVEL	PARAMETER FORMAT	DESCRIPTION
[ :SYStem:]ENableLO Gging/?	RW	R 0 W 1	"0" or "1"	This command enables local logging in the unit that can be used for debugging purposes. Enable this only if a persistent issue exists and ID Photonics asked you to enable the feature since this can slow down the performance of the instrument. The trace file read via RDEBUG is encrypted and cannot be checked by the user.
[ :SYStem:]ReadDEBU G	R	0	-	Collects debug information from OSA which can be sent to ID Photonics for troubleshooting. Returns a maximum of 1000bytes per read. Responds "WAIT" as long as debug data is still collected. Responds "EOL" if all data is read.
[ :SYStem:]IDENTify <wsp><P>	W	0	"0" or "1"	En- or disables blinking of the READY LED on the unit allowing identification of the unit attached to remote control.

## 7.8 COMMUNICATION PORT SETTINGS

SYNTAX	READ WRITE	USER ACCESS LEVEL	PARAMETER FORMAT	DESCRIPTION
[ :SYStem:]IPADDRess /?/<wsp><P>	RW	1	xxx.xxx.xxx.xxx	IP Address Setting of Ethernet interface
[ :SYStem:]DHCP/?/<w sp><P>	RW	1	"off" or "on"	configure DHCP Setting for Ethernet interface.
[ :SYStem:]IPConfigD EFault	W	1	-	Resets all settings of remote interfaces to factory defaults. This becomes effective only after a reboot of the unit.
[ :SYStem:]INTerface Init	W	0	-	Reset session parameters to defaults. Call this after opening the remote port. This command resets ECHO, PASS, FORMAT, UNIT:X, LINLOG, EVENT.
[ :SYStem:]GATEWAYIP /?/<wsp><P>	RW	1	xxx.xxx.xxx.xxx	IP address for Gateway of Ethernet interface
[ :SYStem:]DNSIP/?/< wsp><P>	RW	1	xxx.xxx.xxx.xxx	IP address for 1 <sup>st</sup> DNS
[ :SYStem:]DNSIP2/?/ <wsp><P>	RW	1	xxx.xxx.xxx.xxx	IP address for 2 <sup>nd</sup> DNS

SYNTAX	READ WRITE	USER ACCESS LEVEL	PARAMETER FORMAT	DESCRIPTION
[ :SYStem:]MACADDRESS?	R	0	XX:XX:XX:XX:XX:XX	Reads MAC Address of physical Ethernet interface.
[ :SYStem:]USBIPADDRESS?	R	0	xxx.xxx.xxx.xxx	IP Address of virtual Ethernet interface on USB
[ :SYStem:]USBNETMASK?	R	0	xxx.xxx.xxx.xxx	Netmask Setting of virtual Ethernet interface on USB

## 7.9 OSA SPECIFIC COMMANDS

### 7.9.1 OSA SENSE COMMANDS

COMMAND	PARAMETER OPTIONS
[ :SENSE:SWEEP:]SGL	-
Triggers single sweep. Combines commands SMOD 1 + Init:IMM	
[ :SENSE:SWEEP:]RPT	-
Triggers repeat sweeps; last completed sweep is stored in buffer. Use the command [ :SENSe:SWEEp:TIME:]INTERval/? To introduce fix timed scans.	
[ :SENSE:SWEEP:]AUTO	-
Triggers repeat sweep, equivalent to RPT. Combines commands SMOD 3 + Init:IMM	
[ :SENSE:SWEEP:]NUMBER/?/<wsp><P>	<INT>
<p>Reads or resets OSA Scan number.</p> <p>Each OSA Scan is counted with a consecutive identification number starting from 0 (no scan done yet) since last reboot or instrument reset or counter reset. A write command will reset the counter to 0 or to number sent as parameter.</p> <p>This can be used to query if a scan has been completed by comparing the previous scan number to current. The current scan number is additional returned if trace data is queried allowing synchronization</p> <p>Format: INT64 number.</p>	
[ :SENSe:CORRection:]LEVel:SHIFt/?/<wsp><P>	<REAL32>
Sets/queries the offset value for the power level detected in [dB]. This value will be internally subtracted from measured value. Positive and Negative values are possible.	
[ :SENSe:CORRection:]AVERAge:COUnT/?/<wsp><P>	<INT>
Set or query number of moving averages taken. The averaging starts with first scan and builds up from scan to scan up to limit specified. A counter is available to track the number of scans already taken into account for the average; Each added scan is counted into scan number variable. For single scan mode, one scan is taken and added to the moving average calculation. The maximum moving average window is 100 scans.	
[ :SENSe:CORRection:]AVERAge:CURrentCOUnT?	<INT>
Query number of moving average scans currently taken into moving average calculation	
[ :SENSe:CORRection:]AVERAge:SCANCOUnT/?/<P>	<INT>
Set or query number of averages taken per Scan. Maximum number of scans is 1000. Internally, the unit takes the specified number of scans, calculates the average and reports a single new scan to the user. The scan time	

COMMAND	PARAMETER OPTIONS
per scan will then be a multiplier of the value specified here. A separate command is available to track the progress of the scan acquisition.	
[:SENSe:CORRection:]AVERAge:CURrentSCANCOUNT?	<INT>
Query number of scans taken in the unit to derive the next scan to be provided to the user.	
[:SENSe:CORRection:]WAVeLength:SHIFt/?/<wsp><P>	<REAL32>
Sets/queries the offset value for the wavelength in [m]	
[:SENSe:CORRection:]LEVel:SPEcTralCALibration:Y/?/<wsp><P>	REAL[,64 ,32] AS Cii]
<p>Sets/queries the offset value for the power level detected in [dB] to each spectral data point in max. Resolution. This value will be internally subtracted from measured value. Positive and Negative values are possible. SET: send index of first value (integer) starting at 0 followed by comma separated values in [dB]. Send a maximum of 500 values per write command. IF you want to write all 15600 values, execute several write commands to stitch the full vector together. Value is only permanently saved if "LEVel:SPEcTralCALibration:SAVe" command is executed.</p> <p>Read: A vector of 15600 values is returned. The format is determined by the "[ : ] FORMat [ : DATA ] / ?" setting. At instrument default, all values are 0. See section 6.5 for details.</p>	
[:SENSe:CORRection:]LEVel:SPEcTralCALibration:ENABle/?/<wsp><P>	0 = OFF; 1 = ON
Enables or disables application of stored spectral correction vector defined by LEV:SPECCAL command. See section 6.5 for details.	
[:SENSe:CORRection:]LEVel:SPEcTralCALibration:SAVe	-
Saves the current spectral correction vector to the ID OSA for permanent usage after power cycling. See section 6.5 for details.	
[:SENSe:SWEep:TIME:]INTerval/?/<wsp><P>	<REAL32>
Sets/queries the time taken from the start of a sweep to that of the next sweep when repeat sweeps are made in seconds. If time is smaller than sweep time, sweeps are continuously repeated; Set to 0 to disable this feature	
[:SENSe:WAVeLength:]CENTer/?/<wsp><P>	<REAL32>
Sets/queries the measurement condition center wavelength. The parameter and response in [m]/[Hz] depend on the Base setting of wavelength/Frequency. The sweep span will be automatically clipped if it exceeds the OSA limits.	
[:SENSe:WAVeLength:]SPAN/?/<wsp><P>	<REAL32>
Sets/queries the measurement condition span The parameter and response in [m]/[Hz] depend on the Base setting of wavelength/Frequency	
[:SENSe:WAVeLength:]STARt/?/<wsp><P>	<REAL32>
Sets/queries the measurement condition start wavelength The parameter and response in [m]/[Hz] depend on the Base setting of wavelength/Frequency	
[:SENSe:WAVeLength:]STOP/?/<wsp><P>	<REAL32>

COMMAND	PARAMETER OPTIONS
Sets/queries the measurement condition stop wavelength The parameter and response in [m]/[Hz] depend on the Base setting of wavelength/Frequency	
[:SENSe:WAVeLength:]MINStArT/?	<REAL32>
Queries the minimal start wavelength/frequency supported by Hardware. The parameter and response in [m]/[Hz] depend on the Base setting of wavelength/Frequency If used as a write command, the minimal supported start wavelength/frequency by the H/W is set	
[:SENSe:WAVeLength:]MAXStOP/?	<REAL32>
Queries the maximal start wavelength/frequency supported by Hardware. The parameter and response in [m]/[Hz] depend on the Base setting of wavelength/Frequency If used as a write command, the maximal supported start wavelength/frequency by the H/W is set	
[:SENSe:]INPUt/?	"1" or "2"
Sets/queries which of the 2 optical inputs are used. The power correction is automatically applied. 1: Standard Sensivity 2: High Sensivity Note that any write operation is always permanently saved automatically.	
[:SENSe:SWEep:]StEP/?	<REAL32>
Sets/queries the sampling interval for measurements. The sampling interval (SI) is equal to the Resolution Bandwidth (RBW) if the SI is larger than RBW. If the SI is set to be smaller to RBW, the unit will oversample the available resolution. <ul style="list-style-type: none"> <li>• Automatically setting the sampling interval for measurement (SENSe:SWEep:POINts:AUTO command) is ON, the sampling number to be measured that has been set can be queried.</li> <li>• When the function of automatically setting the sampling number to be measured (SENSe:SWEep:POINts:AUTO command) is ON, this command will be automatically set to OFF.</li> <li>• When the sampling interval for measurement is set using this command, the sampling intervals for measurements (SENSe:SWEep:POINts) will be automatically set. <b>STEP-Value can only be set as a frequency (not wavelength)!</b></li> </ul>	
[:SENSe:SWEep:]StEP:AUTO/?/ <wsp><P>	"0" = OFF; "1" = ON
Queries/Sets the automatic setting of step size.	
[:SENSe:SWEep:]MINStEP/?	-
Sets or reads the minimum Sampling interval in wavelength/frequency supported by H/W. If used as a write command, the minimal possible step size is set to the unit.	
[:SENSe:SWEep:]MAXStEP/?	-
Sets or reads the maximum Sampling interval in wavelength/frequency supported by H/W. If used as a write command, the maximal possible step size is set to the unit.	
[:SENSe:SWEep:]TRIGgerPOLarity/?/ <wsp><P>	'{IN, OUT}', "0" = ACTIVE LOW; "1" = ACTIVE HIGH
Queries/Sets trigger signal polarity of input/output. Trigger IN: 1 (Active high, default) means that a high-level signal triggers a new scan if enabled, 0 will cause a low signal to trigger a new measurement Trigger OUT: 1 (Active high, default) means that a high-level signal is generated if a scan is complete and available to read, it will return low once the next scan is started. The signal is low if no scan was performed yet.	



COMMAND	PARAMETER OPTIONS
The 0 setting will cause the output to be low if a scan is completed and high again once a new scan is triggered. The signal is high if no scan was performed yet.	
[ :SENSE:SWEEP: ] STEP:FREQUENCY/?/ <wsp><P>	<REAL32>
Same as STEP command, except that this command will always query or set frequency values (regardless of UNIT:X mode). The user can use this mode to set the STEP value when wavelength mode is selected through UNIT:X.	
[ :SENSE:SWEEP: ] SYNC/?/ <wsp><P>	0 = OFF; 1 = ON
Queries/Sets the sweep to be triggered by the external sync signal at input	
[ :SENSE:CORRECTION: ] AVERAGE:COUNT/?/ <wsp><P>	<INT>
Set or query number of moving averages taken. The averaging starts with first scan and builds up from scan to scan up to limit specified. A counter is available to track the number of scans already taken into account for the average; Each added scan is counted into scan number variable. For single scan mode, one scan is taken and added to the moving average calculation. The maximum moving average window is 100 scans.	
[ :SENSE:CORRECTION: ] AVERAGE:CURRENTCOUNT?	-
Query number of moving average scans currently taken into moving average calculation	
[ :SENSE:CORRECTION: ] AVERAGE:SCANCOUNT/?/ <wsp><P>	<INT>
Set or query number of averages taken per Scan. Maximum number of scans is 1000. Internally, the unit takes the specified number of scans, calculates the average and reports a single new scan to the user. The scan time per scan will then be a multiple of the value specified here. A separate command is available to track the progress of the scan acquisition.	
[ :SENSE:CORRECTION: ] AVERAGE:CURRENTSCANCOUNT?	<INT>
[ :SENSE:SWEEP: ] TRIGGERDELAY/?/ <wsp><P>	<INT>
Queries/Sets trigger delay for scan trigger IN. Setting the delay will cause the OSA to delay the start of the scan relative to the trigger event by the parameter given in Milliseconds. The 0 setting will cause the scan to be started without delay.	
[ :SENSE:SWEEP: ] POINTS/?/ <wsp><P>	<INT>
Queries the number of samples per sweep measured	
[ :SENSE:SWEEP: ] POINTS:AUTO/? <wsp>/ <P>	0 = OFF; 1 = ON
Queries/Sets the automatic setting of number of samples per sweep measured.	
[ :SENSE:SWEEP: ] MAXPOINTS?	-
Queries/Sets the automatic setting of number of samples per sweep measured.	

### 7.9.2 OSA TRACE COMMANDS

COMMAND	PARAMETER OPTIONS
[ : ] TRACe [ :DATA ] :X? X?	-

COMMAND	PARAMETER OPTIONS
<p>Queries the wavelength axis data; Data is output in the unit of wavelength value [m]; Data is output in the unit of wavelength value [m], regardless of whether this unit is in the wavelength mode or in the frequency mode. The data is equivalent to what is displayed in the GUI. If adjustments such as offset parameters are set, these calculations are included in the data read from the unit by this command. Please note the <code>[ : ] FORMat [ : DATA ] / ? / &lt;wsp&gt;&lt;P&gt;</code> command that controls the format of the data. We recommend to use the binary mode to retrieve the data or use the <code>XY?</code> Command which provides both x and y most efficiently.</p> <p>The number of output data can be acquired by executing <code>:TRACe[:DATA]:SNUMber?</code> plus 1 for the scan number. The data Format is determined by <code>:FORMat[:DATA]/?</code></p>	
<p><code>[ : ] TRACe [ : DATA ] : XAUTO?</code> <code>XAUTO?</code></p>	-
<p>Same as <code>TRAC:X?</code>, but output unit depends on <code>UNIT:X</code> setting (wavelength or frequency)</p>	
<p><code>[ : ] TRACe [ : DATA ] : Y?</code> <code>Y?</code></p>	-
<p>Queries the power level data; The data is output in order of its wavelength from the shortest level to the longest, irrespective of the wavelength/frequency mode. The data is equivalent to what is displayed in the GUI. If averaging or other adjustments such as offset parameters are set, these calculations are included in the data read from the unit by this command. Please note the <code>[ : ] FORMat [ : DATA ] / ? / &lt;wsp&gt;&lt;P&gt;</code> command that controls the format of the data. We recommend to use the binary mode to retrieve the data or use the <code>XY?</code> Command which provides both x and y most efficiently.</p> <ul style="list-style-type: none"> <li>• When the level scale is LOG, data is output in LOG values, see command <code>:TRACe [ : DATA ] : LINLog/?</code></li> </ul>	
<p><code>[ : ] TRACe [ : DATA ] : XY?</code></p>	
<p>Queries the wavelength/frequency axis as well as the power level data in a single command. The output is always sorted in ascending order values of the X vector. The order in the data is <code>X1,Y1,X2,Y2, ..., Xn,Yn</code>. Output is always in REAL32 binary form. Independent of the LINLog setting, the output is always in LOG format (dB values). The command <code>"UNIT : X"</code> can be used to switch between wavelength and frequency mode.</p>	
<p><code>[ : ] TRACe [ : DATA ] : SNUMber/?</code></p>	<INT>
<p>Sets/queries the number of number of data points sampled.</p>	
<p><code>[ : ] TRACe [ : DATA ] : LINLog/?</code></p>	{LIN, LOG}
<p>Sets the output format of power level data trace. If log, output is in [dBm]. If lin, it is [mW]</p>	
<p><code>[ : TRACe : DATA : ] PeaKHOLD / ? / &lt;wsp&gt;&lt;P&gt;</code></p>	"0" or "1" or "2"
<p>Query or Enable/disable Peak hold measurement. 0: disables feature, 1: sets to max Peak hold, 2; set to min Peak hold</p>	
<p><code>[ : TRACe : DATA : ] POWer?</code></p>	<REAL32>
<p>Reads integrated Power of scan</p>	

### 7.9.3 OSA MISCELLANEOUS COMMANDS

COMMAND	PARAMETER OPTIONS
[:INITiate:]SMODE/?/<wsp><P>	{1,2,3} or {SINGLE,REPeat,AUTO}
<p>Sets/queries the sweep mode.            &lt;sweep mode&gt; = Sweep mode            SINGLE = SINGLE sweep mode            REPeat = REPEAT sweep mode            Note that the response to command is given immediately. In Single mode, query *OPC? To wait for scan to finish and update data readout buffer before reading result to avoid reading data from previous scan. In repeat mode, use numb? query to monitor updates of scan before reading result from buffer.</p>	
[:INITiate:]ReaDY?	-
Reports if the module is ready for scanning	
[:]INITiate[:IMMediate] *TRG	-
<p>Starts a sweep            The sweep mode (AUTO, SINGLE, REPEAT) is set using the :INITiate:SMODE command. In Single mode, query *OPC? To wait for scan to finish and update data readout buffer before reading result to avoid reading data from previous scan. In repeat mode, use numb? query to monitor updates of scan before reading result from buffer.</p>	
[:]UNIT:X/? /<P>	0;1 WAV; FREQ
<p>Sets/queries the units for the X axis. Set can be either {0, 1} or {Freq, Wav}. Response options:            0 = WAVelength, 1 = FREQUENCY</p>	
[:]FORMat[:DATA]/?/<wsp><P>	REAL[,64 ,32] AS Cii
<p>Sets/queries the format used for data transfer;            When the format is set to REAL (binary) using this command, the output data of the following commands are produced in the REAL format:            :TRACe[:DATA]:X?            :TRACe[:DATA]:Y?            The factory default is ASCII mode. However, we do not recommend to use this mode for remote scripts using “continuous” mode as this mode produces up to 31200 data points per second (15600 data points per scan at 2 scans per second) which may cause timing issues due to high processing load and glitches in assigning the trace to the according scan. Additionally, parallel sessions such as a Web Interface connection, may experience a significant slowdown of response time.            We recommend to use either the binary mode or to use the “[:]TRACe[:DATA]:XY?” command.            The default mode can be changed using the SCSTAT command.            • When the *RST command is executed, the format is reset to the default mode.            To change the default mode, set the desired mode and execute SCSTAT. Be aware that all settings stored by SCSTAT are saved as well.            • The ASCII format outputs a list of numerics, each of which is delimited by a comma (,).            Example: 12345,12345,...            • By default, the REAL format outputs data in fixed length blocks of 64 bits, floating-point binary numerics.            • If “REAL,32” is specified in the parameter, data is output in the 32-bit, floating-point binary form.</p>	

COMMAND	PARAMETER OPTIONS
<ul style="list-style-type: none"> <li>The fixed length block is defined by IEEE 488.2 and consists of “#” (ASCII), one numeric (ASCII) indicating the number of bytes that specifies the length after #, length designation (ASCII), and binary data of a specified length in this order. Binary data consists of a floating-point data string of 8 bytes (64 bits) or 4 bytes (32 bits). Floating-point data consists of lower order bytes to higher-order bytes. E.g.: #18 [eight &lt;byte data&gt;] #280[80 &lt;byte data&gt;] #48008[8008 &lt;byte data&gt;]</li> <li>For data output in the 32-bit floating-point binary form, cancellation of significant digits is more likely to occur in comparison with transfer of data in the 64-bit, floating-point binary form.</li> </ul>	

#### 7.9.4 OSA CALCULATION COMMANDS

COMMAND	PARAMETER OPTIONS
:CALCulate:CATegory/?<wsp>/WDM	WDM
Queries or sets analysis category, command introduced for compatibility reasons, Parameter: WDM: Peak and OSNR measurement: default Calculation is WDM	
:CALCulate:DATA?	
Queries result of analysis, format: <ch num>,<center wl>,<peak lvl>,<snr>,...	
:CALCulate:DATA:CPOWers?	
Queries the power level data of the WDM measurement. Response is a csv Vector containing the channel powers	
:CALCulate:DATA:CSNR?	
Queries the power OSNR data of the WDM measurement. Response is a csv Vector containing the channel powers	
:CALCulate:DATA:NCHannels?	
Queries the number of channels detected by the WDM peak function. Response is a <INT> number	
:CALCulate:DATA:CWAVelengths?	
Queries the Wavelength of peaks found in WDM peak analysis; response in Frequency or Wavelength depending on UNIT:X setting.	
:CALCulate:DATA:OSLope?	
Queries the slope of peak powers found in WDM peak analysis in unit levels currently set at the unit, i.e. [dB/THz]	
:CALCulate:PARAmeter[:CATegory]:WDM:TH/?/<wsp><P>	
Queries or sets the threshold at which a peak is detected from lowest measured value in [dB]	
:CALCulate:PARAmeter[:CATegory]:WDM:MDIFF/?/<wsp><P>	
Queries or sets the Mode difference between peaks (=drop in power between adjacent peaks required) in [dB]	
:CALCulate:PARAmeter[:CATegory]:WDM:MARea/?/<wsp><P>	
Queries or sets the Channel Mask Area around each peak detected next to which the noise level is measured or mask peak power is calculated in in case peak power integration method is used. Note that the unit needs to be given by unit UNIT:X setting.	
:CALCulate:PARAmeter:CATegory:WDM:MinDIST/?/<wsp><P>	

COMMAND	PARAMETER OPTIONS
Queries or sets the minimum horizontal distance between a detected peak and the next peak. Note that the unit needs to be given by unit UNIT:X setting	
:CALCulate:PARAmeter:CATegory:WDM:POWerINTegrate/ ? / <wsp> <P>	
Queries or sets whether peak power detection integrates power across window (independent on RBW setting) set by or reports peak power measured (depends on RBW setting). Allowed values: 0 = peak / 1= integrate	

## 7.9.5 OSA COMMAND PROPERTY OVERVIEW

The user access level defined by the following table refers to write commands only. All query/read commands can be executed using user access level 0.

### 7.9.5.1 SYSTEM COMMANDS

Session based parameters/commands will be initialized to default each time a new connection/session is opened to the instrument.

SYNTAX	READ WRITE	USER ACCESS LEVEL	SESSION BASED	FACTORY DEFAULT VALUE	STORED BY SCSTAT
[ :SYStem: ] ECHO / ? / <wsp> <P>	RW	0	X	0	-
[ :SYStem: ] SaveCurrStAtE	W	0	-	-	-
[ :SYStem: ] DEFault	W		-	-	-
[ :SYStem: ] INfOrMation?	R	0	-	-	-
[ :SYStem: ] DHCP / ? / <wsp> <P>	RW	1	-	OFF	-
[ :SYStem: ] IPADdRess / ? / <wsp> <P>	RW	1	-	192.168.0.1	-
[ :SYStem: ] NETMAsK / ? / <wsp> <P>	RW	1	-	255.255.255.0	-
[ :SYStem: ] GATEWAYIP / ? / <wsp> <P>	RW	1	-	192.168.0.255	-
[ :SYStem: ] DNSIP / ? / <wsp> <P>	RW	1	-	192.168.0.255	-
[ :SYStem: ] DNSIP2 / ? / <wsp> <P>	RW	1	-	192.168.0.255	-
[ :SYStem: ] MACADdRESS?	R	0	-	-	-
[ :SYStem: ] USBInit	W	0	-	-	-
[ :SYStem: ] REMOte?	R	0	-	-	-
[ :SYStem: ] PASSwOrd / ? / <wsp> <P>	RW	0	X	-	-
[ :SYStem: ] TIME? / <wsp> <P>	R/(W)	0	-	-	-
[ :SYStem: ] ALARm?	R	0	-	-	-
[ :SYStem: ] STATUs?	R	0	-	-	-
[ :SYStem: ] ERRor [ :NEXT ] ?	R		-	-	-

SYNTAX	READ WRITE	USER ACCESS LEVEL	SESSION BASED	FACTORY DEFAULT VALUE	STORED BY SCSTAT
[ :SYSTem:COMMUnicate:]LOCKout/ ?	RW	1	-	0	-
[ :SYSTem:COMMUnicate:]Paramete rREfresh?	R	0	-	0	-
[ :STATus:OPERation:]EVENT?	R	0	-	-	-
[ :]ABORT	W	0	-	-	-
[ :BOOT:]BootLoaDerRESet	W	0	-	-	-
[ :BOOT:] BootLoaDerAPPend	W	0	-	-	-
[ :BOOT:]BootLoaDerEXECute/?	RW	0	-	-	-
[ :SYSTem:]ENableLOGging/?	RW	1	-	0	-
[ :SYSTem:]ReadDEBUG	R	0	-	-	-
[ :SYSTem:]IDENTify <P>	W	0	-	0	-

### 7.9.5.2 OSA COMMANDS

COMMAND	READ WRITE	USER ACCESS LEVEL	FACTORY DEFAULT VALUE	STORED BY SCSTAT
[ :SENSE:SWEEP:]SGL	W	0	-	-
[ :SENSE:SWEEP:]RPT	W	0	-	-
[ :SENSE:SWEEP:]AUTO	W	0	-	-
[ :SENSE:SWEEP:]NUMBer/?	RW	0	0	-
[ :SENSe:SWEEp:]POINTs/?/<wsp><P>	RW	0	15600	✓
[ :SENSe:SWEEp:]POINTs:AUTO/?/<wsp><P >	RW	1	1	✓
[ :SENSe:SWEEp:]MAXPOINTs/?	RW	0	15600	-
[ :SENSe:SWEEp:]STEP/?	RW	0	Defined by optics	✓
[ :SENSe:SWEEp:]STEP:AUTO/?/<wsp><P>	RW	1	1	✓
[ :SENSe:SWEEp:]STEP:FREQuency/?/<wsp ><P>	RW	0	0	✓
[ :SENSe:SWEEp:]MINSTEP?	R	0	Defined by optics	✓
[ :SENSe:SWEEp:]MAXSTEP?	R	0	Defined by optics	✓
[ :SENSe:SWEEp:]SYNC/?/<wsp><P>	RW	0	0	✓

COMMAND	READ WRITE	USER ACCESS LEVEL	FACTORY DEFAULT VALUE	STORED BY SCSTAT
[ :SENSE:SWEEP:] TRIGGERPOLARITY/??/?<wsp><P>/<wsp><P> >	RW	1	1	✓
[ :SENSE:SWEEP:] TRIGGERDELAY/?<wsp>// ?<wsp><P>	RW	0	0	-
[ :SENSE:SWEEP:TIME:] INTERVAL/?	RW	0	0	✓
[ :SENSE:WAVELENGTH:] CENTER/?/<wsp><P> >	RW	0	Defined by optics	✓
[ :SENSE:WAVELENGTH:] SPAN/?/<wsp><P>	RW	0	Defined by optics	✓
[ :SENSE:WAVELENGTH:] START/?/<wsp><P>	RW	0	=MINSTART	✓
[ :SENSE:WAVELENGTH:] STOP/?/<wsp><P>	RW	0	=MAXSTOP	✓
[ :SENSE:WAVELENGTH:] MINSTART?	R	0	Defined by optics	-
[ :SENSE:WAVELENGTH:] MAXSTOP?	R	0	Defined by optics	-
[ :SENSE:] INPUT/?/<wsp><P>	RW	1	1	Always saved
[ :SENSE:CORRECTION:] LEVEL:SHIFT/?/<w sp><P>	RW	0	0	✓
[ :SENSE:CORRECTION:] WAVELENGTH:SHIFT /?/<wsp><P>	RW	0	0	✓
[ :SENSE:CORRECTION:] AVERAGE:COUNT/?/ <wsp><P>	RW	0	1	✓
[ :SENSE:CORRECTION:] AVERAGE: CURRENTCOUNT?	R	0	-	-
[ :SENSE:CORRECTION:] AVERAGE:SCANCOUNT/?/<wsp><P>	RW	0	1	✓
[ :SENSE:CORRECTION:] AVERAGE:CURRENTSCANCOUNT?	R	0	-	-
[ :SENSE:CORRECTION:] LEVEL:SPECTRALCA LIBRATION:Y/?	RW	1	0	-
[ :SENSE:CORRECTION:] LEVEL:SPECTRALCA LIBRATION:ENABLE/?	RW	1	0	✓
[ :SENSE:CORRECTION:] LEVEL:SPECTRALCA LIBRATION:SAVE	W	1	-	-
[ :] TRACE[:DATA]:X? X?	R	0	-	-
[ :] TRACE[:DATA]:XAUTO?	R	0	-	-

COMMAND	READ WRITE	USER ACCESS LEVEL	FACTORY DEFAULT VALUE	STORED BY SCSTAT
XAUTO?				
[:] TRACe[:DATA]:SNUMber/?	RW	0	0	-
[:] TRACe[:DATA]:Y? Y?	R	0	-	-
[:] TRACe:DATA:] POWer?	R	0	-	-
[:] TRACe:DATA:] PeaKHoLD/?/ <wsp><P>	RW	0	0	-
[:] TRACe[:DATA]:LINLog/?	RW	0	LOG	-
:CALCulate:CATegory/? <wsp>/WDM	RW	0	WDM	-
:CALCulate:DATA?	R	0	-	-
:CALCulate:DATA:CPOWers?	R	0	-	-
:CALCulate:DATA:CSNR?	R	0	-	-
:CALCulate:DATA:NCHannels?	R	0	-	-
:CALCulate:DATA:CWAVelengths?	R	0	-	-
:CALCulate:DATA:OSLope?	R	0	-	-
:CALCulate:PARAMeter[:CATegory]:WDM: TH/?/ <wsp><P>	RW	1	20	✓
:CALCulate:PARAMeter[:CATegory]:WDM: MDIFF/?/ <wsp><P>	RW	1	3	✓
:CALCulate:PARAMeter[:CATegory]:WDM: MAREa/?/ <wsp><P>	RW	1	100	✓
:CALCulate:PARAMeter:CATegory:WDM:PO WerINTEgrate/?/ <wsp><P>	RW	1	0	✓
:CALCulate:PARAMeter:CATegory:WDM:Mi nDIST/?/ <wsp><P>	RW	1	0	✓
[:] INITiate:] SMODE/?/ <wsp><P>	RW	1	1	✓
[:] INITiate:] ReaDY?	R	0	-	-
[:] INITiate[:IMMediate] *TRG	W	0	-	-
[:] FORMat[:DATA]/?	RW	0	ASCII	✓
[:] UNIT:X/?/ <wsp><P>	RW	0	1 (Frequ)	-

## 7.10 SCPI CODE ERROR DEFINITION

ERROR #	DESCRIPTION
100	Command Syntax Command error
101	Parameter out of range
102	No data in buffer
103	device not ready



ERROR #	DESCRIPTION
104	user level for this command not sufficient
200	Command execution error
201	user level rights to execute this command not sufficient, increase using <code>PASS</code> command
250	calculation error; no scan data for calculation available
251	calculation error; no peaks or too many peaks detected
252	calculation error; one or more noise point out of measurement range

### 7.11 ALARM CODE DEFINITION

The following table details potential alarms raised by the unit. The alarm status can be queried using the “alarm?” command. The response is an ASCII coded unsigned 16-bit integer number, little endian. Convert this number into binary format to retrieve the alarm status. Each “1” bit represents an active alarm.

The most common responses to “alarm?” are:

0: no alarm

1: Optics not ready

2: Optical Power too high

Use the SCPI Command “\*cls” to clear all latched alarms.

BIT #	ALARM	CONDITION/DESCRIPTION
0	Init; Optics not ready	After cold start, the optics requires about 45 seconds to become operational. The alarm is automatically cleared once operational
1	Optical Input Power too high	The optical power applied to the unit input is too high. The measurement may be still ok but no validity is given.
2	Optics failure	Pending failure in the detection optics. Contact ID Photonics for guidance.
3	Optics failure (latched)	A failure in the detection optics was detected.
4	System failure	Pending failure of the unit. Contact ID Photonics for guidance.
5	System failure (latched)	A failure of the unit was detected.
6	Not used	
7	Not used	
8	Not used	
9	Not used	
10	internal	
11	internal	
12	internal	
13	internal	
14	internal	
15	internal	

## 8 UNINSTALLING GUI SOFTWARE

This only applies if you have installed the optional installable GUI. Software may be uninstalled by either using the well-known central Windows built-in “Add/remove Programs” function or by running “setup.exe” from installation medium again.

The logo for IDPHOTONICS GMBH, featuring the company name in a blue, sans-serif font. The 'O' in 'PHOTONICS' is stylized with a circular arrow around it. A small 'GMBH' is written in a smaller font to the right of 'PHOTONICS'.

**IDPHOTONICS** GMBH

# SHAPING LIGHT.

HELPING ENGINEERS AND  
SCIENTISTS IN  
ADVANCING HOW THE  
WORLD COMMUNICATES,  
SENSES AND CONNECTS



TUNABLE  
LASER



TRANSMITTER  
SOLUTIONS

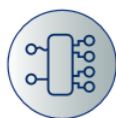

RECEIVER  
SOLUTIONS



SPECTRAL  
ANALYSIS



Anton-Bruckner-Strasse 6  
85579 Neubiberg  
GERMANY  
Tel: +49-89-201 899 16  
[info@id-photonics.com](mailto:info@id-photonics.com)  
[id-photonics.com](http://id-photonics.com)

All rights reserved. No part of this publication may be reproduced, stored in a retrieval system or transmitted in any form, be it electronically, mechanically, or by any other means such as photocopying, recording or otherwise, without the prior written permission of ID Photonics GmbH. Information provided by ID Photonics GmbH is believed to be accurate and reliable. However, no responsibility is assumed by ID Photonics GmbH for its use nor for any infringements of patents or other rights of third parties that may result from its use. No license is granted by implication or otherwise under any patent rights of ID Photonics GmbH. The information contained in this publication is subject to change without notice.